

RoHS

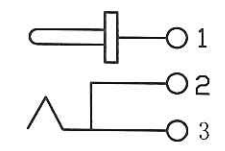
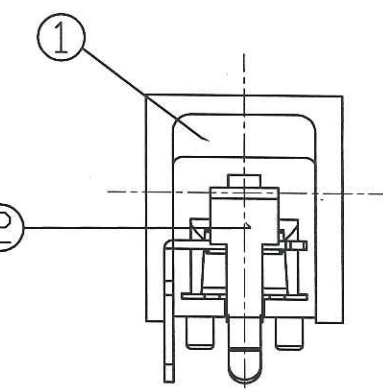
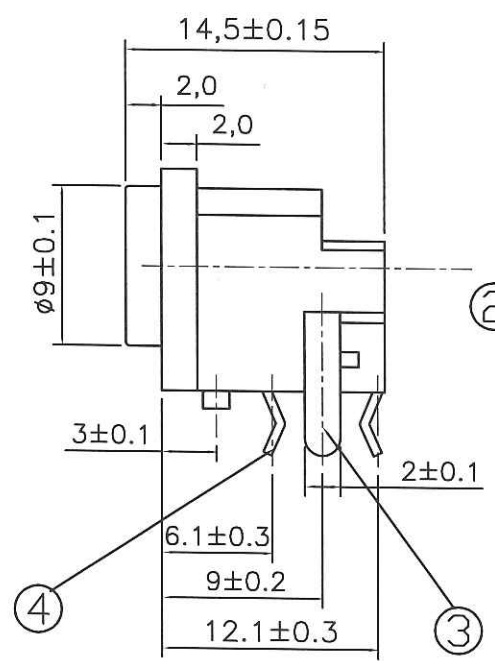
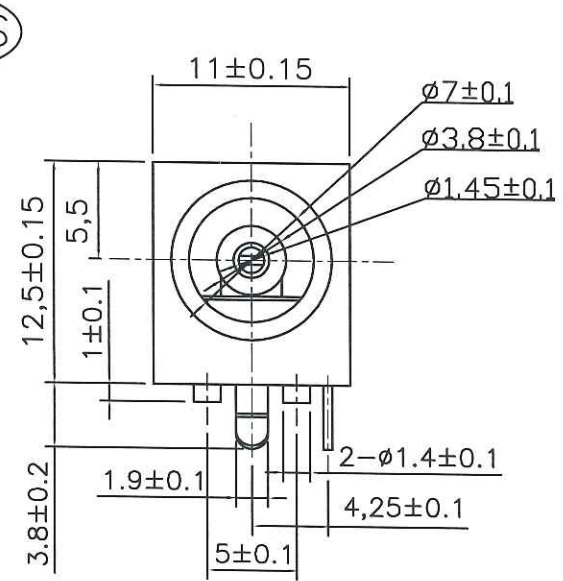

SCHEMATIC

SPECIFICATION

- 1.MECHANICAL PERFORMANCE:  
 1-1 Insertion force:30N Max.  
 1-2 Removal force:3-30N.  
 1-3 Durability: 5000 cycles.
- 2.ELECTRICAL PERFORMANCE:  
 2-1.Current rating: 2A  
 2-2.Voltage rating: 30V MAX  
 2-3.Contact resistance:≤30mΩ.  
 After test:≤50mΩ.  
 2-4.Insulation resistance;≥100MΩ;  
 After test:≥50MΩ.  
 2-5.Withstanding voltage:500VAC.  
 2-5.DIELECTRIC WITHSTANDING VOLTAGE: 500V AC Min
- 3.ENVIRONMENTAL PERFORMANCE:  
 3-1 Operation temperature range:-20°C~70°C.  
 3-2 Preservative temperature range:-40°C~85°C.
4. TECHNOLOGY TEMP.  
 4-1 Manual welding temperature: 350±5°C 3s(±1s)  
 4-2 Melting temperature of plastic: 195°C
- 5.The Product Using Material And Processing  
 Must Conform To The "WL-PZ-142"Hsf  
 Technical Standard Control Requirements
- 6.P/N:

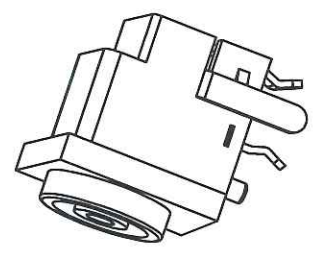
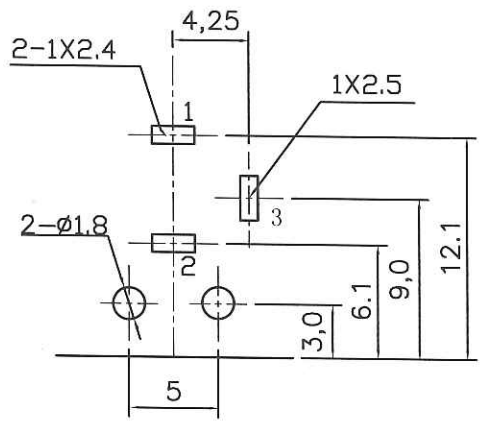

70018 W 9-0 03 A-09 Q XX

- ① Series No.                      ⑦ Contact Plated:  
 5A-All Au G/F  
 2E-Bright Tin  
 09-Ag
- ② W : Female
- ③ 9 : DIP90°
- ④ 0 : N/A
- ⑤ No. of Circuits
- ⑥ COLOR:  
 A-Black  
 K-White  
 0-NATURE
- ⑧ Package Spec:  
 Q-PE BAG
- ⑨ Water code  
 01-TYPE-A

PCB HOLES (PATTERN SIDE) t=1.6mm  
 NOTE:GENERAL TOLERANCE:±0.1mm

①	SMITCH TERMINAL	2	1	C5191 T=0.25	Ag-PLATED
②	S-TERMINAL	3	1	H65 T=0.5	Ag-PLATED
③	HOESING	1	1	H65 T=0.5	Ag-PLATED
④	NO.			PBT	BLACK
	PART NAME	TER. NO.	QTY	MATERIAL	REMARK

REV.	REVISION RECORD	DATE	UNIT: MM	GENERAL TOLERANCES		SCALE 1:1	NAME	DATE	PART NO.	DWG. NO.	 TERMINAL&CONNECTORS			
				LINEAR	ANGLES									
			SIZE: A4	0.00±0.25	X'±3°		马剑	2022.11.04	70018W9-003A-09Q01	ENDE05				
				0.00±0.10	X'X'±2°		马学峰	2022.11.04						
							侯兰宣	2022.11.04	DC JACK 1.45 直脚弹片					

RoHS

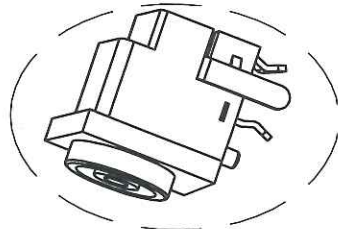

产品



PE袋  
(500pcs)

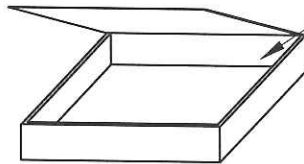

内盒

内箱 (5x500=2500pcs)

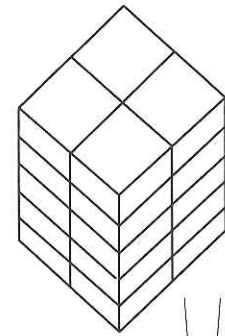

5层

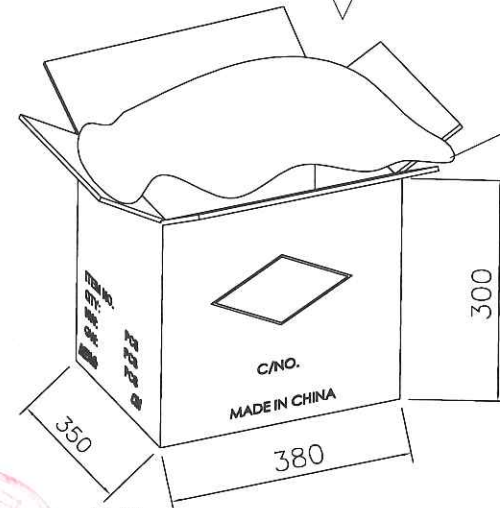

PE Bag

外箱  
(4x2500=10,000pcs)

REV.	REVISION RECORD	DATE		GENERAL TOLERANCES		SCALE 1:1	NAME	DATE	PART NO.	DWG NO.	<b>JCTC</b> <sup>®</sup> TERMINAL&CONNECTORS	
				LINEAR	ANGLES	APPROVED	王剑	2020.11.04	70018WR-003A-09Q01	ENDE05		
			UNIT: MM	0.00±0.25	X'±3'	DESIGNER	马行军	2020.11.04	TITLE			
			SIZE: A4	0.000±0.10	X'X'±2'	DRAWN	侯建勇	2022.11.06	DC JACK OD1.40 R/D DIP PACKING SPEC			
1									REV	A0	SHEET	2/2

