

The product using material and processing must conform to the "WL-PZ-001" HSF technical standard control requirements

RoHS+HF

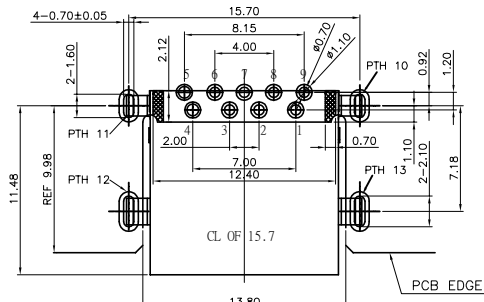
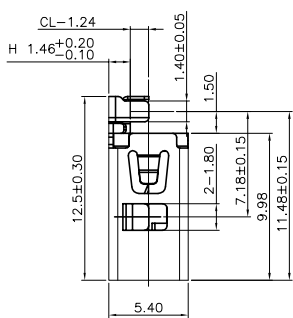
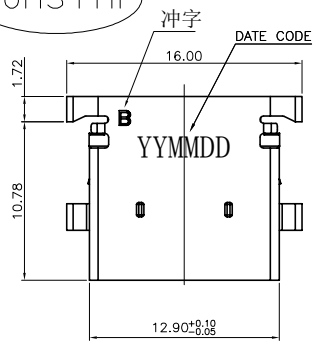

TOLERANCE: ±0.05, THICKNESS: 1.0~1.2mm  
RECOMMENDED PCB LAYOUT  
(TOP VIEW)  
KEEP OUT AREA

NOTE:  
1. MATERIAL SPECIFICATION:  
1-1. HOUSING: LCP E4711; UL94V-0, BLACK  
1-2. CONTACTS: C5210 EH  
1-3. SHELL: SUS210 H  
2. PLATING SPECIFICATION:  
2-1. CONTACTS:  
50u" MIN Ni UNDERPLATING,  
GOLD PLATING ON CONTACT AREA AND  
80u" MIN MATTE TIN PLATING ON SOLDER AREA.  
2-2. SHELL:  
50u" MIN. SOLDERABLE NICKEL ALL OVER.  
3. MECHANICAL PERFORMANCE:  
3-1 MATING FORCE: 6~20 N Max  
3-2 UNMATED FORCE: 10N~25N INITIAL;  
8N~20N Min AFTER TEST  
3-3 DURABILITY: 5,000 CYCLES  
4. ELECTRICAL PERFORMANCE:  
4-1. CURRENT RATING: 2A  
4-2. CONTACT RESISTANCE: 30mΩ MAX  
4-3. INSULATION RESISTANCE: 100MΩ Min  
4-4. DIELECTRIC WITHSTANDING VOLTAGE: 500 V R.M.S.  
5. ENVIRONMENTAL PERFORMANCE:  
5-1. OPERATING TEMPERATURE: -40°C~+85°C.  
6. PACKAGE SPEC: REEL  
7. P/N: WL U3 F 9-09 8 1 A 0 208

SERIES NO. \_\_\_\_\_  
TYPE: U3-USB3.0  
F-FEMALE  
M-MALE  
ANGLE: 9-90°  
PIN Q'PY: 09-09PIN

Water code. \_\_\_\_\_  
OPTION: 0-N/A  
HOUSING COLOUR: A-BLACK, C-BLUE  
PLATING: 1-G/F, 8-OFFSET TYPE

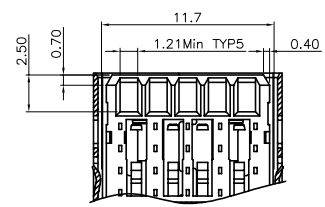
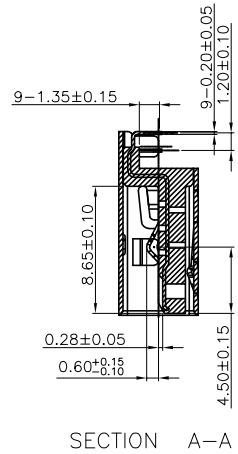
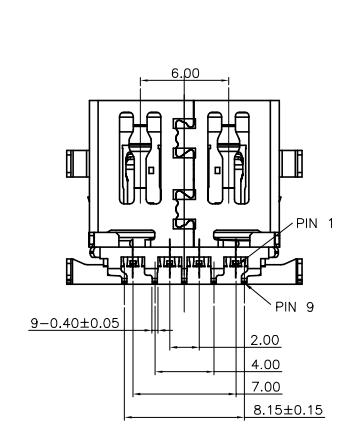
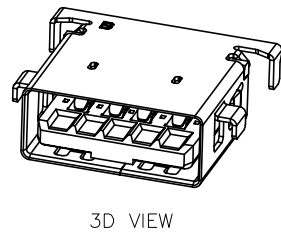
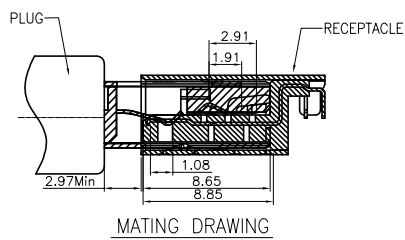
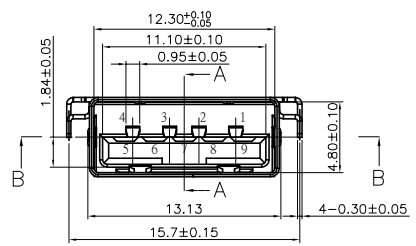

Pin #	SIGNAL NAME	DESCRIPTION	MATING SEQUENCE
1	VBUS	POWER	SECOND
2	D-	USB 2.0 DIFFERENTIAL PAIR	THIRD
3	D+		
4	GND	GROUND FOR POWER RETURN	SECOND
5	StdA_SSRX-	SUPERSPEED RECEIVER DIFFERENTIAL PAIR	LAST
6	StdA_SSRX+		
7	GND_DRAIN	GROUND FOR SIGNAL RETURN	
8	StdA_SSTX-	SUPERSPEED TRANSMITTER DIFFERENTIAL PAIR	
9	StdA_SSTX+		
Shell	Shield	CONNECTOR METAL SHELL	FRIST

REV.	REVISION RECORD	DATE	GENERAL TOLERANCES		SCALE:	NAME	DATE	PART.NO:	DWG.NO:	 WanLian Teconology Co., Ltd REV: A1 SHEET: 1/1
A1	变更铁壳脚宽度, 改善铁壳脚负重破裂	22.3.17	 LINEAR 0.0±0.35 UNIT:mm SIZE: A4	 ANGLES X'REF±6° X'±3° X'X' ±2°	1:1	Wang_jr	22.03.17	WLUF9-0981A0208	ENDE05	
					APPROVED	DESIGNER	Han_Gao	22.03.17	TITLE:	
					DRAWN	Zijun_Huang	22.03.17			