

The product using material and processing must conform to the "WL-PZ-001"HSF technical standard control requirements

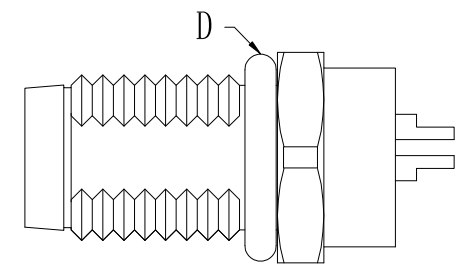

	2pin	3pin	4pin
图形			
CODE	A-code	A-code	A-code

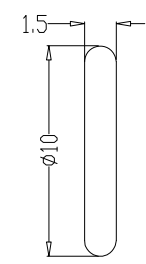
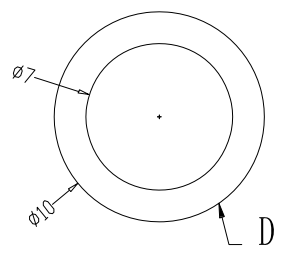
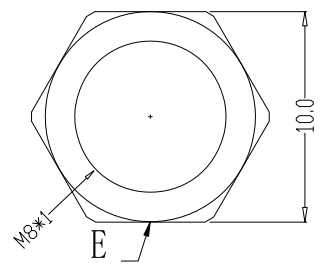
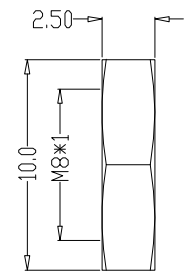
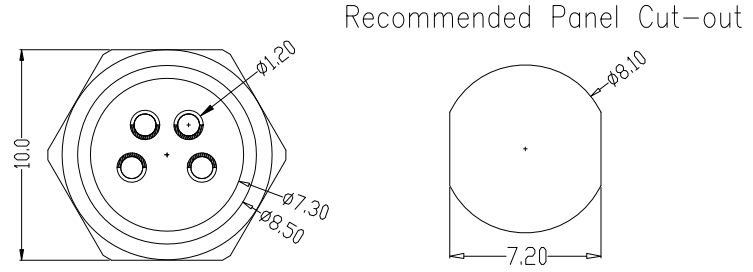
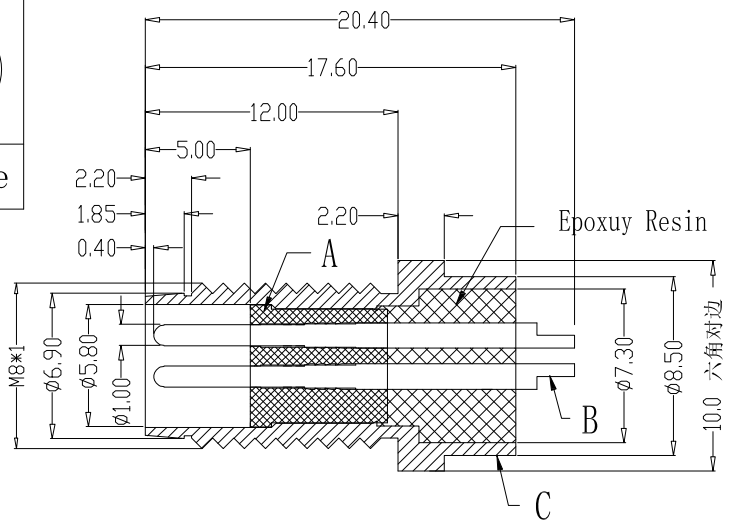
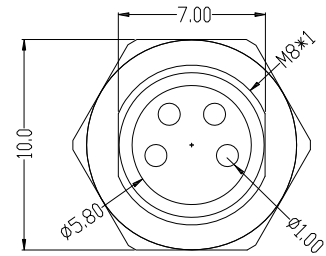

P/N	TITLE	Engagemnt fire	Disengagement force	Mechanical lifespan	IP rating	Flammability	Rated voltage	Rated current	Insulation resistance	Contract resistance	Operation Temperature	PARTS	MARERIALS	TREATMENT	AMOUNT	
M08A02-03-033	M8防水 A-CODE 2P线端头 前锁面板式M8 SW10-17.6全金属	≤30N	≥5N	≥500	IP67/IP68	UL94 V-0	60v	4A	≥1000MΩ	≤10MΩ	-40° C~105° C	A	HOUSING	PA66+GF	SPECIFY COLOR	1
M08A03-03-033	M8防水 A-CODE 3P线端头 前锁面板式M8 SW10-17.6全金属											B	CONTACT	BRASS	GOLD PLATED	2~4
M08A04-03-033	M8防水 A-CODE 4P线端头 前锁面板式M8 SW10-17.6全金属											C	OUTER CONTACT	BRASS	NICKL PLATED	1
												D	O-RING	EPDM	BLACK	1
												E		BRASS	NICKL PLATED	1

REV.	REVISION RECORD	DATE		GENERAL TOLERANCES		SCALE: 1:1	NAME	DATE	PART.NO:	DWG.NO:	 WanLian Technology Co., Ltd
AO	NEW RELEASE	21.11.17		LINEAR	ANGLES	APPROVED			M08XXX-03-033	ENDE05	
			UNIT:mm	0.00±0.25	X°±3°	DESIGNER			TITLE:		REV: AO
			SIZE: A4	0.000±0.10	X°X'±2°	DRAWN			M8防水 2~4P线端头 前锁面板式M8 SW10-17.6全金属		SHEET: 1/1