

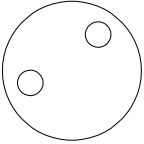

The product using material and processing must conform to the "WL-PZ-001"HSF technical standard control requirements

RoHS

	2pin	3pin	4pin
图形			
CODE	A-code	A-code	A-code

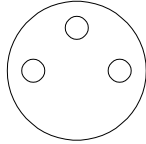
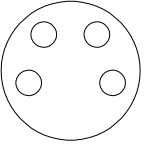
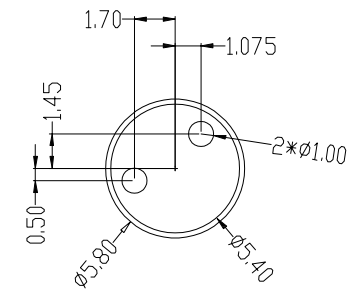
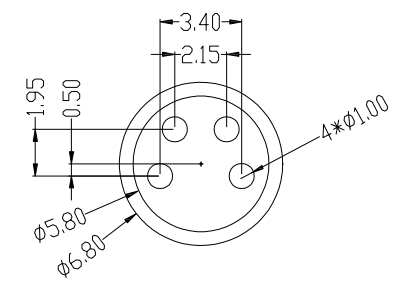
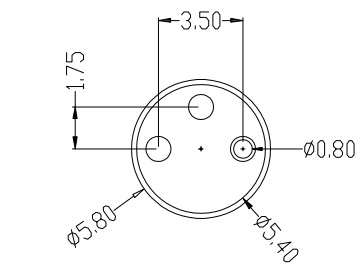
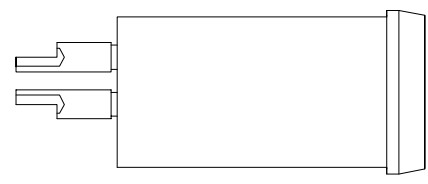
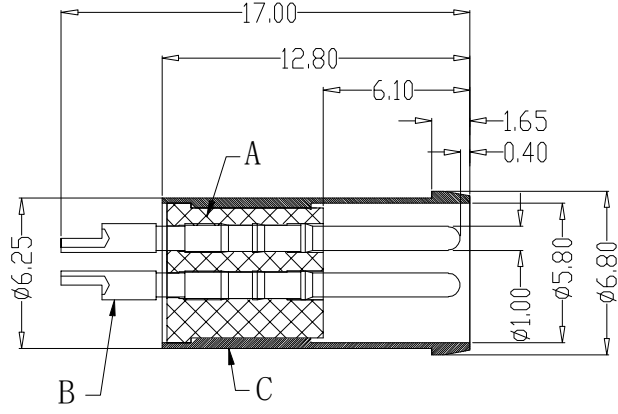
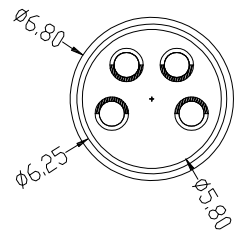

P/N	TITLE	Engagemr firce	≤30N	Rated voltage	60V	PARTS	MARERIALS	TREATMENT	AMOUNT	
M08A02-07-011	M8防水 A-CODE 2P 线端公头 全屏蔽款17L	Disengagement force	≥5N	Rated current	4A	A	HOUSING	PA66+GF	SPECIFY COLOR	1
M08A03-07-011	M8防水 A-CODE 3P 线端公头 全屏蔽款17L	Mechanical lifespan	≥500	Insulation resirance	≥1000MΩ	B	CONTACT	BRASS	GOLD PLATED	2~4
M08A04-07-011	M8防水 A-CODE 4P 线端公头 全屏蔽款17L	IP rating	IP67/IP68	Conract resistangce	≤10MΩ	C	SHIELD	BRASS	NICKL PLATED	1
		Flammability	UL94 V-0	Operation Temperature	-40° C~105° C	D				

REV.	REVISION RECORD	DATE		GENERAL TOLERANCES		SCALE: 1:1	NAME	DATE	PART.NO: M08XXX-07-012	DWG.NO: ENDE05	 WanLian Technology Co., Ltd
A0	NEW RELEASE	21.11.17		LINEAR	ANGLES						
			UNIT:mm	0.0±0.35	X'REF±6°	DESIGNER			TITLE: M8防水 2~4P线端公头全屏蔽款17L		REV: A0
			SIZE: A4	0.00±0.25	X'±3'	DRAWN					SHEET: 1/1