

The product using material and processing must conform to the "WL-PZ-001" HSF technical standard control requirements

RoHS

图形						
CODE	A-code	A-code	A-code	B-code	A-code	A-code

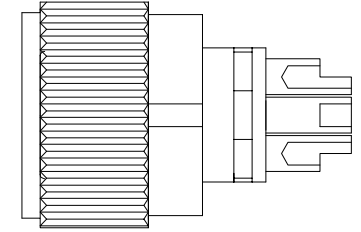
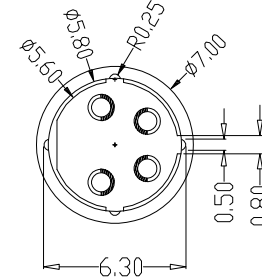
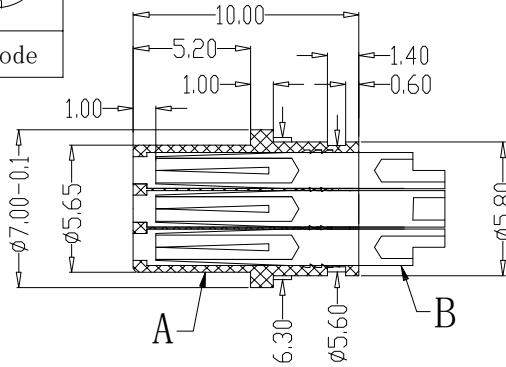
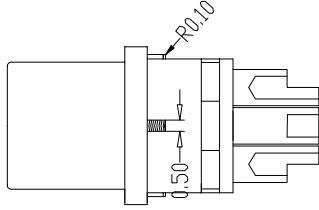
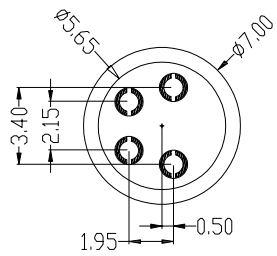

组合图

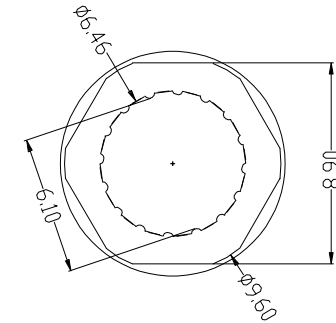
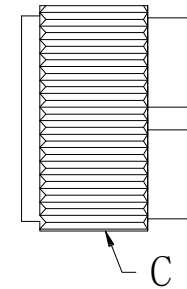
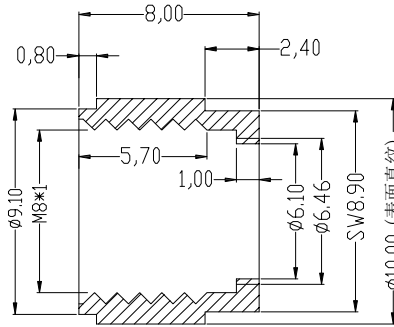
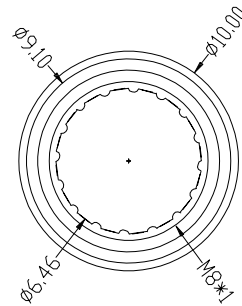
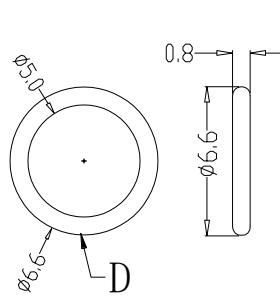

P/N	TITLE	Engagemer firce	Rated voltage	2-5pin:60v DC 6-8PIN:30V DC	PARTS	MARERIALS	TREATMENT	AMOUNT
M08A02-08-010	M8防水 A-CODE 2P 线端母头+8L防振六角螺母	≤40N	Rated voltage		A	HOUSING	PA66+GF	SPECIFY COLOR 1
M08A03-08-010	M8防水 A-CODE 3P 线端母头+8L防振六角螺母	Disengagement force ≥5N	Rated current	2-5pin:4A 6-8PIN:2A	B	NUT	BRONZE	GOLD PLATED 2~8
M08A04-08-010	M8防水 A-CODE 4P 线端母头+8L防振六角螺母	Mechanical lifespan ≥500	Insulation resistance	≥1000MΩ	C	OUTER CONTACT	BRASS	NICKL PLATED 1
M08B05-08-010	M8防水 B-CODE 5P 线端母头+8L防振六角螺母	IP rating	Conract resistangce	≤10MΩ	D	O-RING	EPDM	BLACK 1
M08A06-08-010	M8防水 A-CODE 6P 线端母头+8L防振六角螺母	Flammability	Operation Temperature	-40° C~105° C	E			
M08A08-08-010	M8防水 A-CODE 8P 线端母头+8L防振六角螺母							

REV.	REVISION RECORD	DATE	GENERAL TOLERANCES		SCALE:	NAME	DATE	PART.NO:	DWG.NO:
A0	NEW RELEASE		LINEAR	ANGLES	1:1			M08XXX-08-010	ENDE05
			0.0±0.35	X'REF±6'	APPROVED				
			0.00±0.25	X'±3'	DESIGNER			TITLE:	
			0.000±0.10	X'X' ±2'	DRAWN			M8防水 2~8P线端母头+8L防振六角螺母	
									REV: A0 SHEET: 1/1

