

The product using material and processing must conform to the "WL-PZ-001"HSF technical standard control requirements

RoHS

图形																		
规格	2PIN	2PIN	2PIN 4改2	3PIN	3PIN	3PIN 4改3	4PIN 2+2	4PIN	5PIN	5PIN 正方形2+3	5PIN 180°	5PIN 260° 2+3	5PIN 360°	6PIN 360°	6PIN 258°	6PIN 8改6	7PIN	8PIN
X值	1.20	1.50	1.00	1.20	1.50	1.00	1.20+1.00	1.00	1.00	1.50+1.00	0.80	1.50+1.00	1.00	1.00	0.80	0.80	0.80	0.80

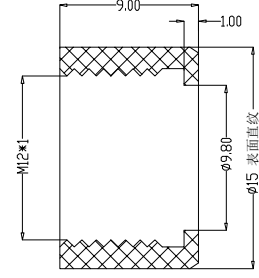
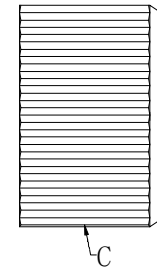
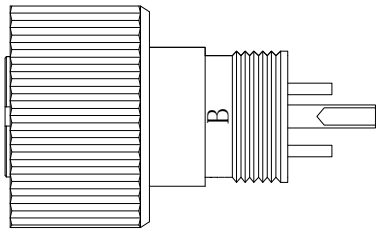
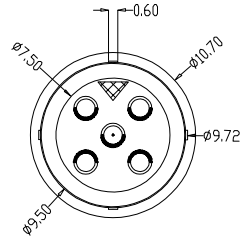
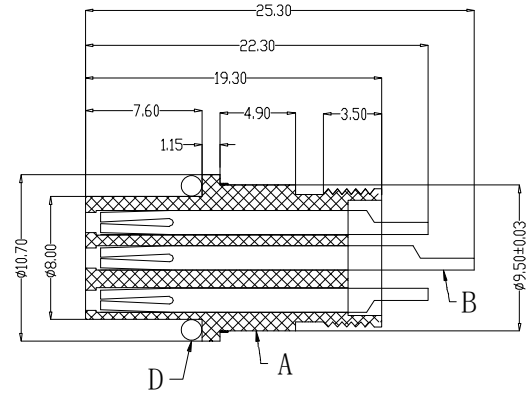
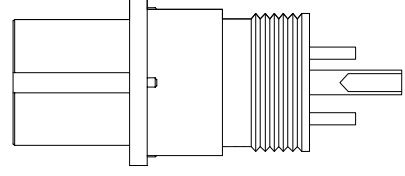
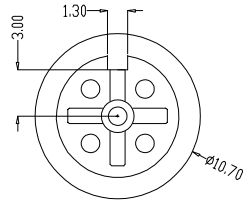

组合图

Engagemnr firce	≤50N	Rated volage	2-5pin:60v 6-8pin:30v	PARTS	MARERIALS	TREATMENT	AMOUNT
Disengagement force	≥5N	Rated current	2-5pin:4A 6-8pin:2A				
Mechanical lifespan	≥500	Insulation resirance	≥1000MΩ				
IP rating	IP67/IP68	Conract resistangce	≤10MΩ				
Flammability	UL94 V-0	Operation Temperature	-40° C~105° C				
A	HOUSING	PA66+GF	SPECIFY COLOR	1			
B	CONTACT	BRASS	GOLD PLATED	2			
C	NUT	ALALLOY	BLACK/SILVER	1			
D	O-RING	EPDM	BLACK	1			

P/N	TITLE
M12A02-08-073	M12防水 A-CODE 2P线端母头 B款9.0L铝螺母 4改2 1.0*2

REV.	REVISION RECORD	DATE
A0	NEW RELEASE	

GENERAL TOLERANCES		SCALE:
LINEAR	ANGLES	1:1
0.0±0.35	X'REF±6'	APPROVED
0.00±0.25	X'±3'	DESIGNER
0.000±0.10	X'X' ±2'	DRAWN

NAME	DATE

PART.NO:
M12A02-08-073
TITLE:
M12防水 A-CODE 2P线端母头 B款9.0L铝螺母 4改2 1.0*2

DWG.NO:
ENDE05



REV: A0	SHEET: 1/1
---------	------------