

The product using material and processing must conform to the "WL-PZ-001" HSF technical standard control requirements

RoHS

图形																		
规格	2PIN	2PIN	2PIN 4改2	3PIN	3PIN	3PIN 4改3	4PIN 2+2	4PIN	5PIN	5PIN 正方形2+3	5PIN 180°	5PIN 260° 2+3	5PIN 360°	6PIN 360°	6PIN 258°	6PIN 8改6	7PIN	8PIN
X值	1.20	1.50	1.00	1.20	1.50	1.00	1.20+1.00	1.00	1.00	1.50+1.00	0.80	1.50+1.00	1.00	1.00	0.80	0.80	0.80	0.80

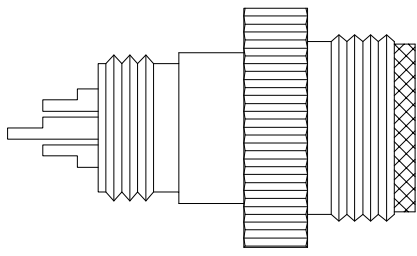
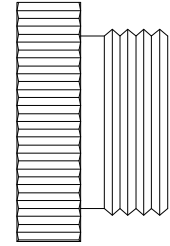
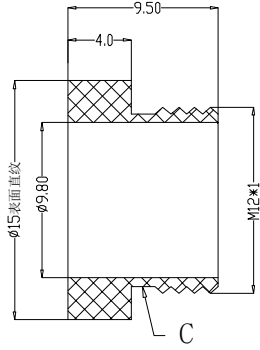
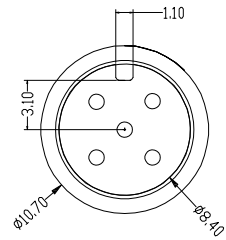
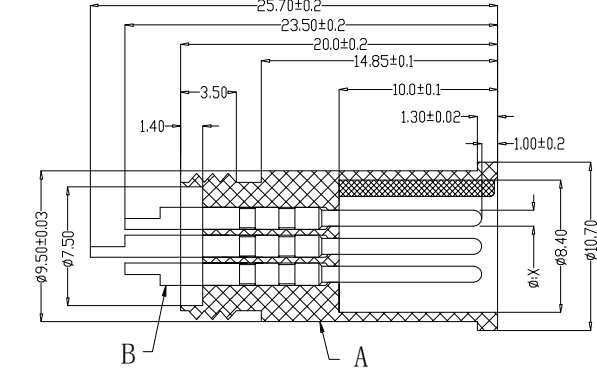
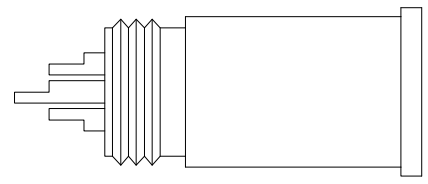
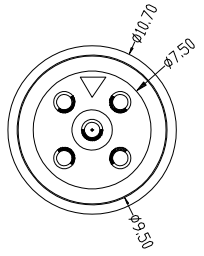

组合图

Engagemer firce	≤50N	Rated volage	2-5pin:60v 6-8pin:30v	PARTS	MARERIALS	TREATMENT	AMOUNT
Disengagement force	≥5N	Rated current	2-5pin:4A 6-8pin:2A	A	HOUSING	PA66+GF	SPECIFY COLOR 1
Mechanical lifespan	≥500	Insulation resirance	≥1000MΩ	B	CONTACT	BRASS	GOLD PLATED 5
IP rating	IP67/IP68	Conract resistangce	≤10MΩ	C	NUT	ALALLOY	BLACK/SILVER 1
Flammability	UL94 V-0	Operation Temperature	-40° C~105° C	D			
				E			

P/N	TITLE
M12A05-07-087	M12防水 A-CODE 5P线端公头 B款9.5L铝螺丝 260度2+3 1.5+1.0

REV.	REVISION RECORD	DATE	GENERAL TOLERANCES		SCALE:	NAME	DATE	PART.NO:	DWG.NO:	 WanLian Technology Co., Ltd	
A0	NEW RELEASE		LINEAR	ANGLES	1:1			M12A05-07-087	ENDE05		
			0.0±0.35	X'REF±6'	APPROVED						
			UNIT:mm	0.00±0.25	DESIGNER			TITLE:			
			SIZE: A4	0.000±0.10	DRAWN			M12防水 A-CODE 5P线端公头 B款9.5L铝螺丝260度2+3 1.5+1.0		REV: A0	SHEET: 1/1