

The product using material and processing must conform to the "WL-PZ-001"HSF technical standard control requirements

RoHS

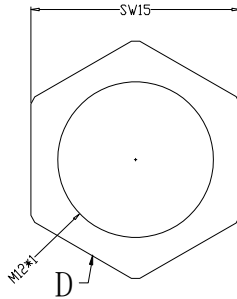

Recommended Panel Cut-out

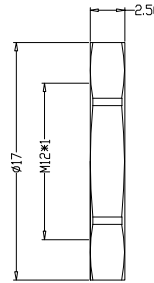
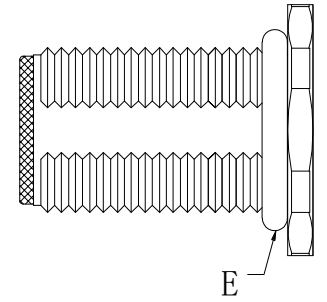
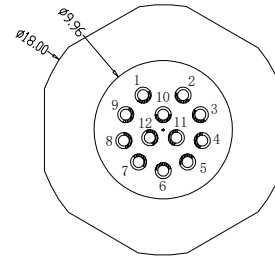
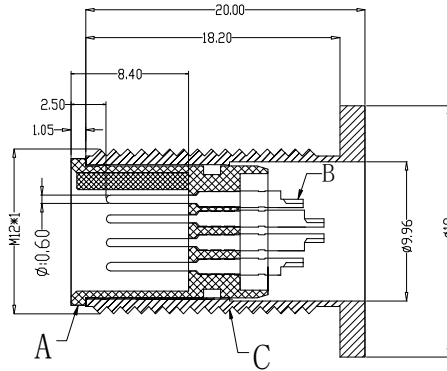
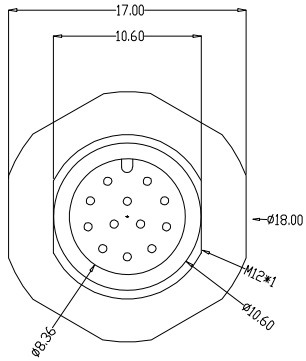
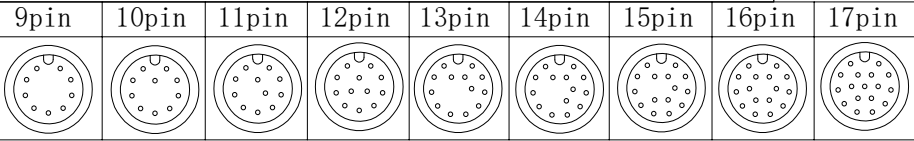
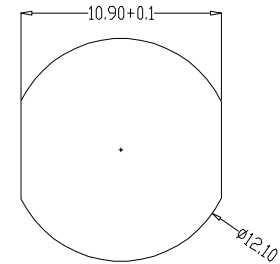

P/N	TITLE
M12A09-03-108	M12防水 A-CODE 9P线端公头 前锁面板式M12 SW17T后灌胶
M12A10-03-108	M12防水 A-CODE 10P线端公头 前锁面板式M12 SW17T后灌胶
M12A11-03-108	M12防水 A-CODE 11P线端公头 前锁面板式M12 SW17T后灌胶
M12A12-03-108	M12防水 A-CODE 12P线端公头 前锁面板式M12 SW17T后灌胶
M12A13-03-108	M12防水 A-CODE 13P线端公头 前锁面板式M12 SW17T后灌胶
M12A14-03-108	M12防水 A-CODE 14P线端公头 前锁面板式M12 SW17T后灌胶
M12A15-03-108	M12防水 A-CODE 15P线端公头 前锁面板式M12 SW17T后灌胶
M12A16-03-108	M12防水 A-CODE 16P线端公头 前锁面板式M12 SW17T后灌胶
M12A17-03-108	M12防水 A-CODE 17P线端公头 前锁面板式M12 SW17T后灌胶

Engagemer firce	≤50N	Rated volage	30V		PARTS	MARERIALS	TREATMENT	AMOUNT
Disengagement force	≥10N	Rated current	1.5A	A	HOUSING	PA66+GF	SPECIFY COLOR	1
Mechanical lifespan	≥500	Insulation resirance	≥1000MΩ	B	CONTACT	BRASS	GOLD PLATED	9~17
IP rating	IP67/IP68	Conract resistangce	≤10MΩ	C	OUTER CONTACT	BRASS	NICKL PLATED	1
Flammability	UL94 V-0	Operation Temperature	-40° C~105° C	D	NUT	BRASS	NICKL PLATED	1
				E	O-RING	EPDM	BLACK	1

REV.	REVISION RECORD	DATE	UNIT:mm	GENERAL TOLERANCES	SCALE:	NAME	DATE	PART.NO:	DWG.NO:
A0	NEW RELEASE			LINEAR	1:1			M12XXX-03-108	ENDE05
				ANGLES					
				0.0±0.35					
				X'REF±6'					
				0.00±0.25					
				X'±3'					
				0.000±0.10					
				X'X' ±2'					

WanLian Technology Co., Ltd

TITLE: M12防水 9~17P线端公头 前锁板式M12 SW17T后灌胶

REV: A0 SHEET: 1/1