

The product using material and processing must conform to the "WL-PZ-001" HSF technical standard control requirements

RoHS

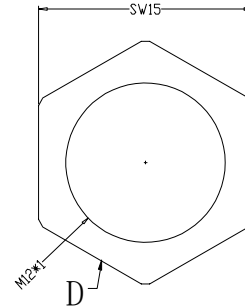

Recommended Panel Cut-out

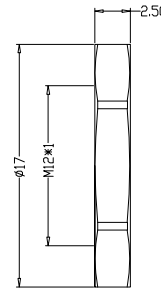
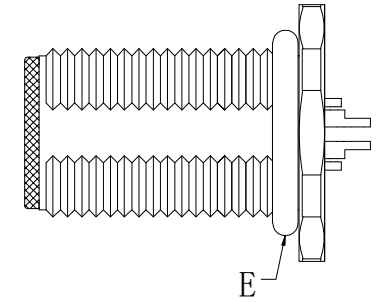
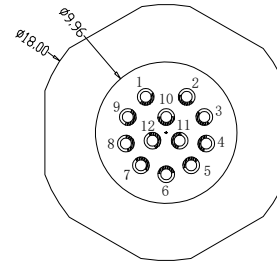
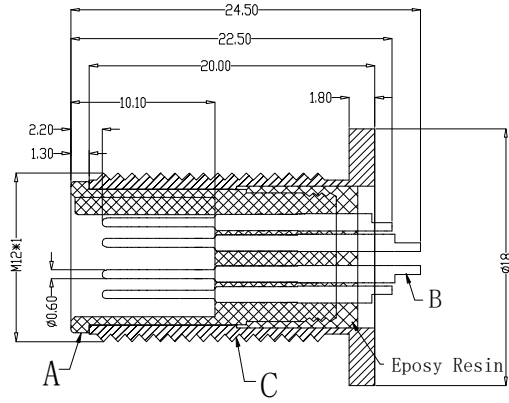
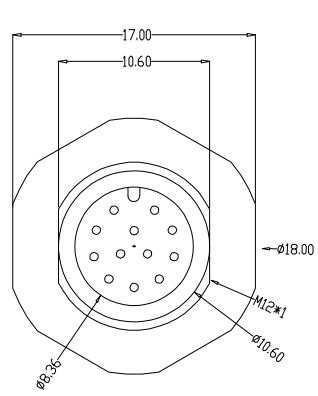
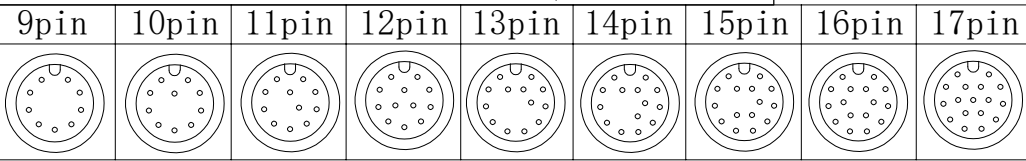
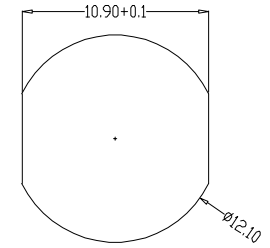

P/N	TITLE
M12A09-03-112	M12防水 A-CODE 09P线端公头 前锁面板式M12 SW17T
M12A10-03-112	M12防水 A-CODE 10P线端公头 前锁面板式M12 SW17T
M12A11-03-112	M12防水 A-CODE 11P线端公头 前锁面板式M12 SW17T
M12A12-03-112	M12防水 A-CODE 12P线端公头 前锁面板式M12 SW17T
M12A13-03-112	M12防水 A-CODE 13P线端公头 前锁面板式M12 SW17T
M12A14-03-112	M12防水 A-CODE 14P线端公头 前锁面板式M12 SW17T
M12A15-03-112	M12防水 A-CODE 15P线端公头 前锁面板式M12 SW17T
M12A16-03-112	M12防水 A-CODE 16P线端公头 前锁面板式M12 SW17T
M12A17-03-112	M12防水 A-CODE 17P线端公头 前锁面板式M12 SW17T

Engagemer firce	≤50N	Rated volage	30V	PARTS	MARERIALS	TREATMENT	AMOUNT	
Disengagement force	≥10N	Rated current	1.5A		A	HOUSING	PA66+GF	SPECIFY COLOR 1
Mechanical lifespan	≥500	Insulation resistance	≥1000MΩ		B	CONTACT	BRASS	GOLD PLATED 9~17
IP rating	IP67/IP68	Conract resistangce	≤10MΩ		C	OUTER CONTACT	BRASS	NICKL PLATED 1
Flammability	UL94 V-0	Operation Temperature	-40° C~105° C		D	NUT	BRASS	NICKL PLATED 1
				E	O-RING	EPDM	BLACK 1	

REV.	REVISION RECORD	DATE	GENERAL TOLERANCES		SCALE:	NAME	DATE	PART.NO:	DWG.NO:	 万连科技 WanLian Technology Co., Ltd	
A0	NEW RELEASE		LINEAR	ANGLES	1:1			M12XXX-03-112	ENDE05		
			0.0±0.35	X'REF±6°	APPROVED						
			UNIT:mm	X'±3'	DESIGNER			TITLE:			
			SIZE: A4	X'X' ±2'	DRAWN			M12防水 9~17P线端公头 前锁板式M12 SW17T			
										REV: A0	SHEET: 1/1