

The product using material and processing must conform to the "WL-PZ-001"HSF technical standard requirements

RoHS

Recommended Panel Cut-out

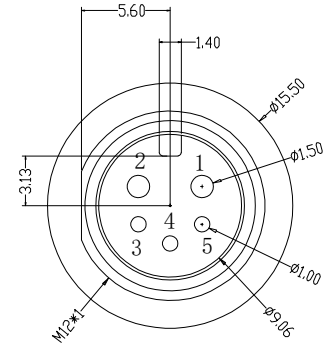
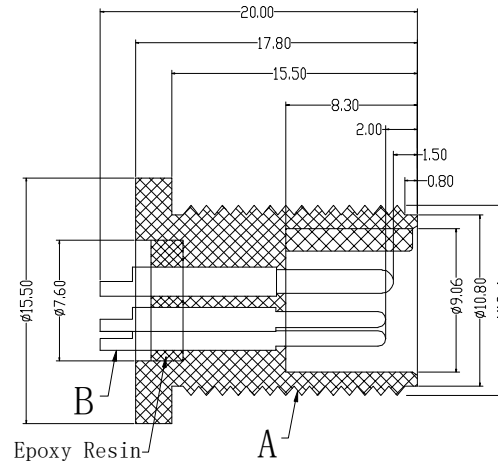
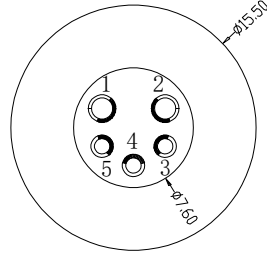
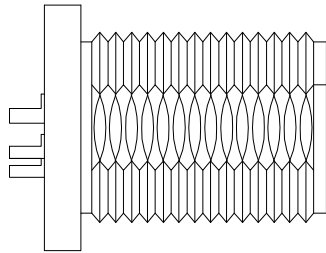
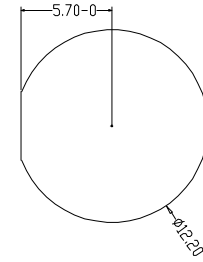
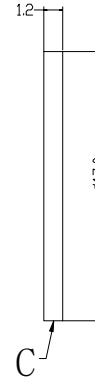
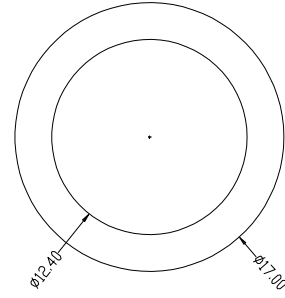
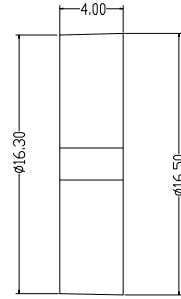
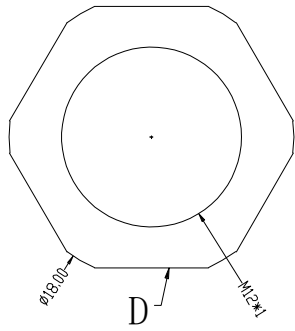

Engagemnt firce	≤50N	Rated voltage	60v	PARTS	MARERIALS	TREATMENT	AMOUNT
Disengagement force	≥5N	Rated current	7.5A	A	HOUSING	PA66+GF	SPECIFY COLOR 1
Mechanical lifespan	≥500	Insulation resistance	≥1000MΩ	B	CONTACT	BRASS	GOLD PLATED 5
IP rating	IP67/IP68	Conract resistangce	≤10MΩ	C	SHIM	SILICA GEL	BLACK 1
Flammability	UL94 V-0	Operation Temperature	-40° C~105° C	D	NUT	PA66+GF	BLACK 1

P/N	TITLE
M12Y05-03-139	M12防水 5P线端公头 Y-CODE前锁面板 Y-AX款

REV.	REVISION RECORD	DATE		GENERAL TOLERANCES		SCALE: 1:1	NAME	DATE	PART.NO: M12XXX-03-139	DWG.NO: ENDE05	 WanLian Technology Co., Ltd
A0	NEW RELEASE	21.11.17		LINEAR	ANGLES						
				0.0±0.35	X'REF±6°						
			UNIT:mm	0.00±0.25	X'±3'				TITLE: M12防水 5P线端公头 Y-CODE 前锁面板式Y-AX款		REV: A0
			SIZE: A4	0.000±0.10	X'X' ±2'						SHEET: 1/1