

The product using material and processing must conform to the "WL-PZ-001"HSF technical standard control requirements

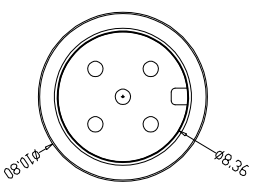

PIN位	2pin	3pin	4pin	5pin	6pin	7pin	8pin
X 值	1.00	1.00	1.00	1.00	0.80	0.80	0.80

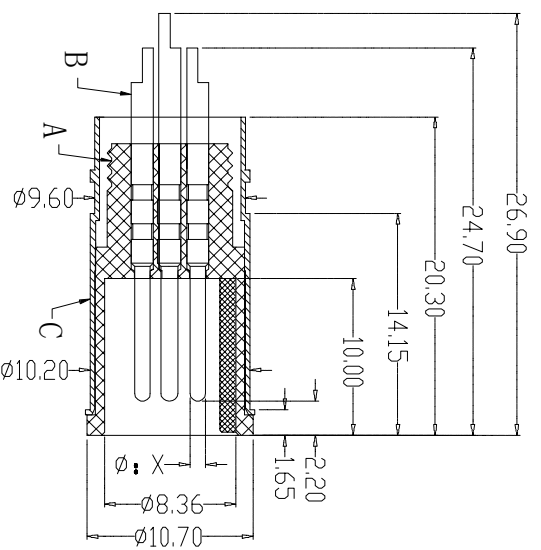
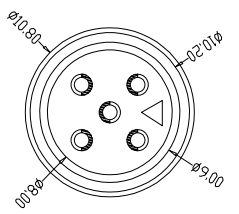
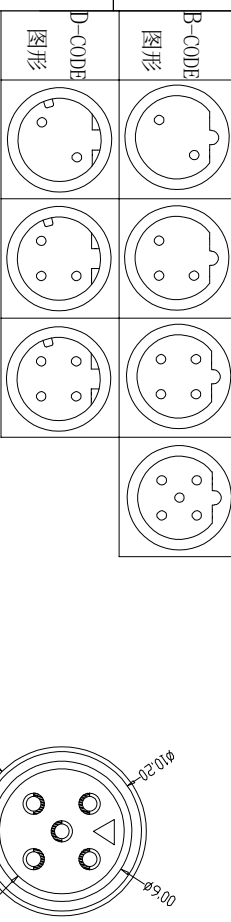

P/N	TITLE
M12A02-07-068	M12防水 A-CODEE 2P线端公头 屏蔽款+10.8L直纹螺丝
M12A03-07-068	M12防水 A-CODEE 3P线端公头 屏蔽款+10.8L直纹螺丝
M12A04-07-068	M12防水 A-CODEE 4P线端公头 屏蔽款+10.8L直纹螺丝
M12A05-07-068	M12防水 A-CODEE 5P线端公头 屏蔽款+10.8L直纹螺丝
M12A06-07-068	M12防水 A-CODEE 6P线端公头 屏蔽款+10.8L直纹螺丝
M12A07-07-068	M12防水 A-CODEE 7P线端公头 屏蔽款+10.8L直纹螺丝
M12A08-07-068	M12防水 A-CODEE 8P线端公头 屏蔽款+10.8L直纹螺丝
M12B02-07-068	M12防水 B-CODEE 2P线端公头 屏蔽款+10.8L直纹螺丝
M12B03-07-068	M12防水 B-CODEE 3P线端公头 屏蔽款+10.8L直纹螺丝
M12B04-07-068	M12防水 B-CODEE 4P线端公头 屏蔽款+10.8L直纹螺丝
M12B05-07-068	M12防水 B-CODEE 5P线端公头 屏蔽款+10.8L直纹螺丝
M12D02-07-068	M12防水 D-CODEE 2P线端公头 屏蔽款+10.8L直纹螺丝
M12D03-07-068	M12防水 D-CODEE 3P线端公头 屏蔽款+10.8L直纹螺丝
M12D04-07-068	M12防水 D-CODEE 4P线端公头 屏蔽款+10.8L直纹螺丝

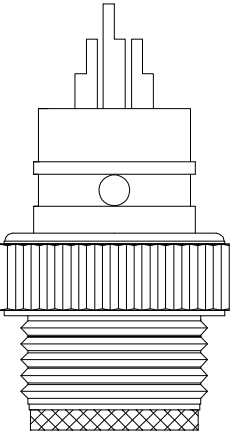

组合图

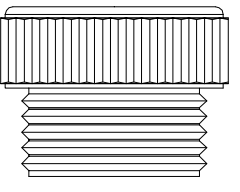
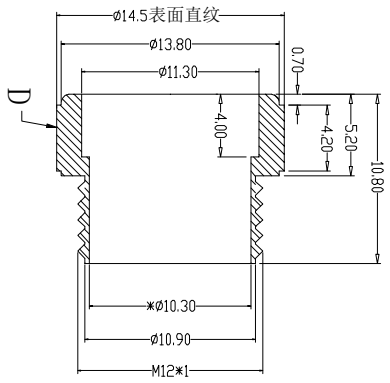

REV.	REVISION RECORD	DATE	GENERAL TOLERANCES	SCALE:	NAME	DATE	PART.NO.:	DWG.NO.:
AO	NEW RELEASE	21.11.17	LINEAR 0.0±0.35	1:1			M12XXX-07-068	ENDE05
			ANGLES X'REF±6°	APPROVED				
			UNIT:mm 0.00±0.25	DESIGNER				
			SIZE:A4 0.000±0.10	DRAWN				



Wanlian Technology Co., Ltd

REV: AO SHEET: 1/1

REV.	REVISION RECORD	DATE	GENERAL TOLERANCES	SCALE:	NAME	DATE	PART.NO.:	DWG.NO.:
1			LINEAR 0.0±0.35	1:1			M12XXX-07-068	ENDE05
			ANGLES X'REF±6°	APPROVED				
			UNIT:mm 0.00±0.25	DESIGNER				
			SIZE:A4 0.000±0.10	DRAWN				

REV: AO SHEET: 1/1