

The product using material and processing must conform to the "WL-PZ-001"HSF technical standard control requirements

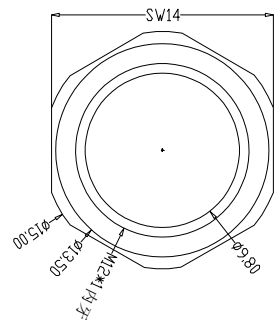
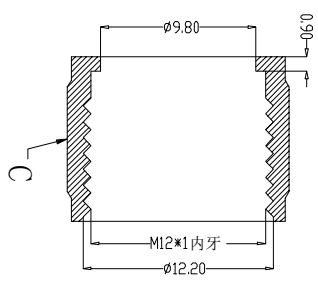
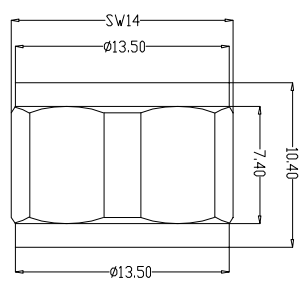
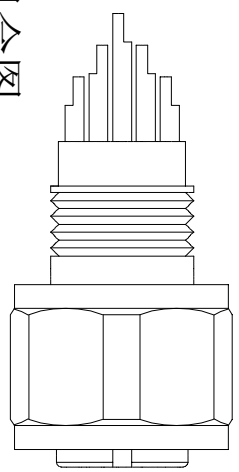
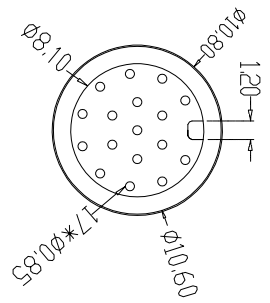
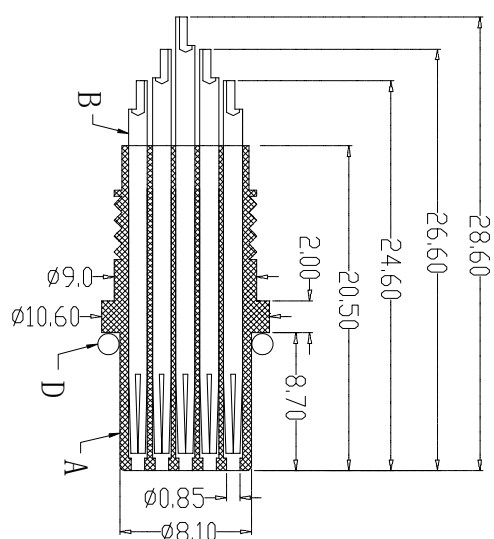
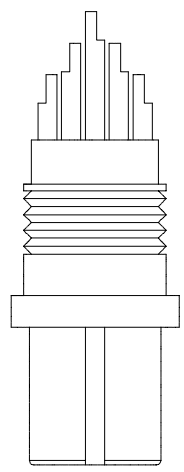
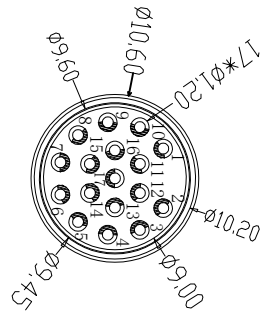
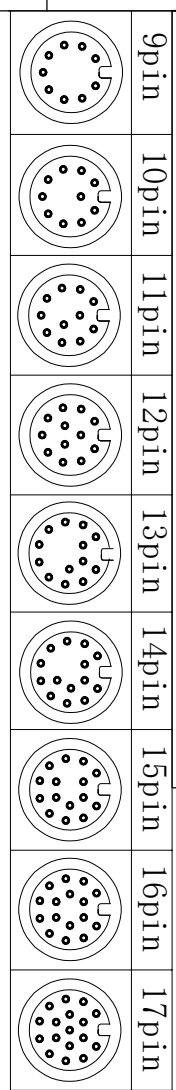

组合图

TITLE

P/N	TITLE
M12A09-08-088	M12防水 A-CODE 09P线端母头 C+10.4L 六角螺母
M12A10-08-088	M12防水 A-CODE 10P线端母头 C+10.4L 六角螺母
M12A11-08-088	M12防水 A-CODE 11P线端母头 C+10.4L 六角螺母
M12A12-08-088	M12防水 A-CODE 12P线端母头 C+10.4L 六角螺母
M12A13-08-088	M12防水 A-CODE 13P线端母头 C+10.4L 六角螺母
M12A14-08-088	M12防水 A-CODE 14P线端母头 C+10.4L 六角螺母
M12A15-08-088	M12防水 A-CODE 15P线端母头 C+10.4L 六角螺母
M12A16-08-088	M12防水 A-CODE 16P线端母头 C+10.4L 六角螺母
M12A17-08-088	M12防水 A-CODE 17P线端母头 C+10.4L 六角螺母

Engagement force	Rated voltage	30V	PARTS	MATERIALS	TREATMENT	AMOUNT
≤50N	Rated voltage	30V	A HOUSING	PA66+GF	SPECIFY COLOR	1
≥10N	Rated current	1.5A	B CONTACT	BRASS	GOLD PLATED	9*17
≥500	Insulation resistance	≥1000MΩ	C NUT	BRASS	NICKL PLATED	1
IP rating	Contract resistance	≤10MΩ	D O-RING	EPDM	BLACK	1
Flammability	Operation Temperature	-40° C~105° C	E			

REVISION RECORD	DATE	GENERAL TOLERANCES	SCALE:	NAME	DATE	PART.NO:	DWG.NO:
NEW RELEASE	21.11.17	LINEAR ANGLES X'REF±6°	1:1	APPROVED		M12XXX-08-088	ENDE05

REVISION RECORD	DATE	GENERAL TOLERANCES	SCALE:	NAME	DATE	PART.NO:	DWG.NO:	REV:	SHEET:
NEW RELEASE	21.11.17	LINEAR ANGLES X'REF±6°	1:1	APPROVED		M12XXX-08-088	ENDE05	AO	1/1
		UNIT:mm SIZE:A4	0.0±0.35 X'±3°	DESIGNER					
		0.00±0.25	X'X' ±2°	DRAWN					
		0.000±0.10							



Wanlian Technology Co., Ltd