

The product using material and processing must conform to the "WL-PZ-001"HSF technical standard control requirements

pin位	2pin	3pin	4pin	5pin	6pin	7pin	8pin
A-CODE 图形							
B-CODE 图形							
D-CODE 图形							

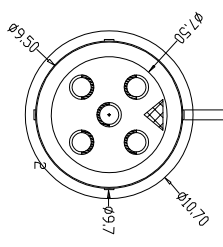

组合图

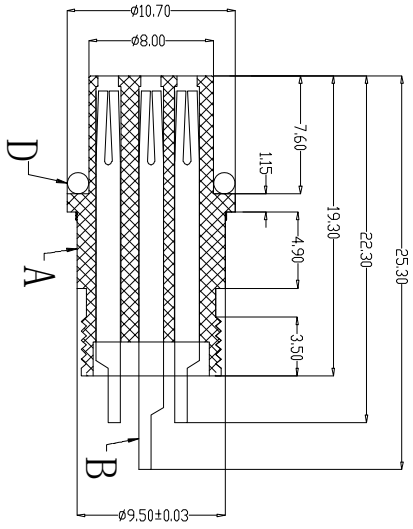
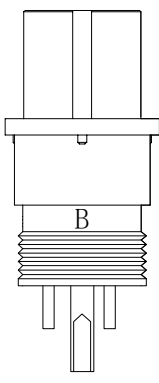
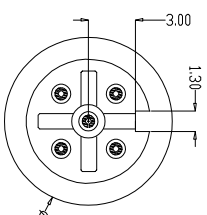
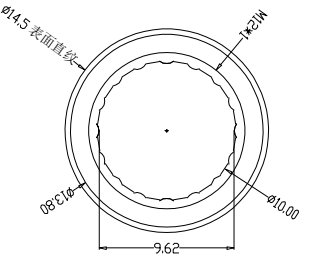
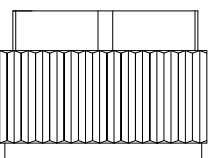
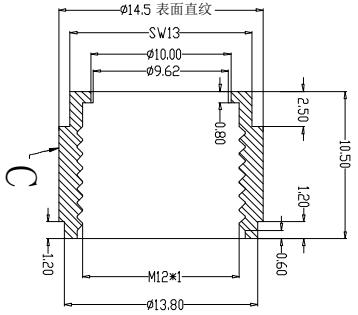
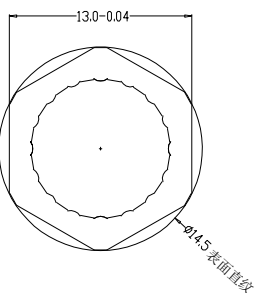
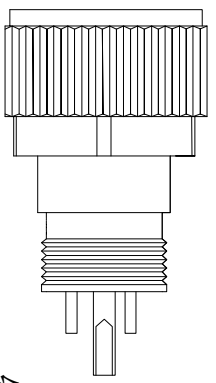

P/N	TITLE	Engagement force	Rated voltage	2-5pin: 60V 6-8pin: 30V	PARTS	MATERIALS	TREATMENT	AMOUNT
M12A02-08-111	M12防水 A-CODE 2P线端母头 B款10.5L防振六角螺母	$\leq 50N$	Rated voltage	2-5pin: 60V 6-8pin: 30V	A HOUSING	PA66+GF	SPECIFY COLOR	1
M12A03-08-111	M12防水 A-CODE 3P线端母头 B款10.5L防振六角螺母	$\geq 5N$	Rated current	2-5pin: 4A 6-8pin: 2A	B CONTACT	BRASS	GOLD PLATED	2*8
M12A04-08-111	M12防水 A-CODE 4P线端母头 B款10.5L防振六角螺母	≥ 500	Insulation resistance	$\geq 1000M\Omega$	C NUT	BRASS	NICKL PLATED	1
M12A05-08-111	M12防水 A-CODE 5P线端母头 B款10.5L防振六角螺母	IP67/IP68	Contract resistance	$\leq 10M\Omega$	D O-RING	EPDM	BLACK	1
M12A06-08-111	M12防水 A-CODE 6P线端母头 B款10.5L防振六角螺母	Flammability	Operation Temperature	-40° C ~ 105° C	E			
M12A07-08-111	M12防水 A-CODE 7P线端母头 B款10.5L防振六角螺母							
M12A08-08-111	M12防水 A-CODE 8P线端母头 B款10.5L防振六角螺母							
M12B02-08-111	M12防水 B-CODE 2P线端母头 B款10.5L防振六角螺母							
M12B03-08-111	M12防水 B-CODE 3P线端母头 B款10.5L防振六角螺母							
M12B04-08-111	M12防水 B-CODE 4P线端母头 B款10.5L防振六角螺母							
M12B05-08-111	M12防水 B-CODE 5P线端母头 B款10.5L防振六角螺母							
M12D02-08-111	M12防水 D-CODE 2P线端母头 B款10.5L防振六角螺母							
M12D03-08-111	M12防水 D-CODE 3P线端母头 B款10.5L防振六角螺母							
M12D04-08-111	M12防水 D-CODE 4P线端母头 B款10.5L防振六角螺母							

REV.	REVISION RECORD	DATE	GENERAL TOLERANCES		SCALE:	NAME	DATE	PART.NO:	DWG.NO:	<p>Wanlian Technology Co., Ltd</p>
AO	NEW RELEASE	21.11.17	LINEAR	ANGLES	1:1			M12XXX-08-111	ENDE05	
			0.0±0.35	X'REF±6°	APPROVED					REV: AO
			0.00±0.25	X'±3'	DESIGNER					SHEET: 1/1
			0.000±0.10	X'X' ±2'	DRAWN					
			TITLE:		M12防水 2~8P线端母头 B款10.5L防振六角螺母					