

The product using material and processing must conform to the "WI-PZ-001"HSF technical standard control requirements

RoHS

备注:

- 1: 包装数量: 16盘/箱512pcs;
- 2: 纸箱规格: 34*25*24CM

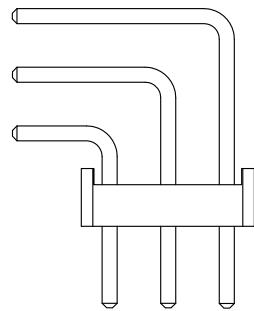

2. 54三排针 3x23p
90度 产品.

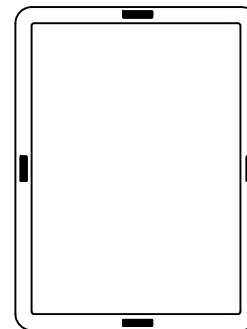
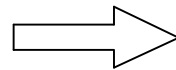

产品放入真空盒,
每盒32PCS.

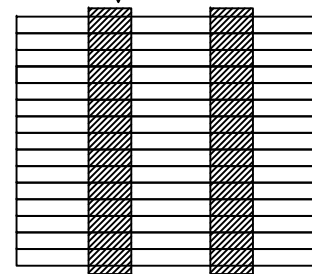
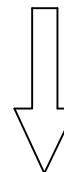

叠好16盘, 真空盒最上面放一个空盒, 然后整体用缠绕膜缠好.

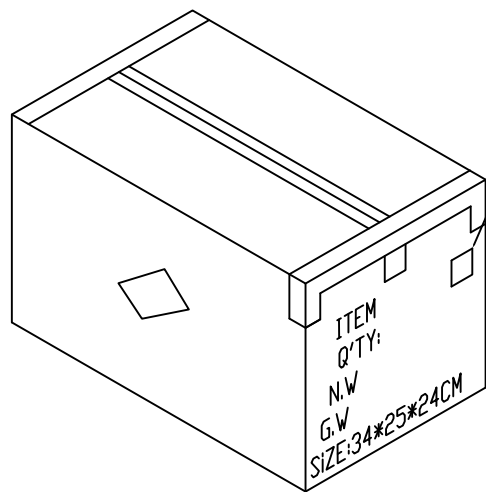

外箱标签贴在侧唛右上角、

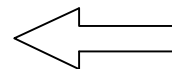

外箱封口“工”字型,
一箱数量512pcs, 16盘.

| | | | | | | | | | | | |
|------|-----------------|----------|----------|--------------------|----------|---------------|---------|----------|--|---------|---------------------------------|
| REV. | REVISION RECORD | DATE | | GENERAL TOLERANCES | | SCALE: 1:1 | NAME | DATE | PART.NO: | DWG.NO: | WanLian Technology Co., Ltd |
| A0 | NEW RELEASE | 21.11.17 | | LINEAR | ANGLES | APPROVED | Wang_jr | 23.06.13 | PH254125M9-3XX1XXX02 | ENDE05 | |
| | | | UNIT: mm | 0.00±0.25 | X°±3° | DESIGNER | Han_Gao | 23.06.13 | TITLE: Pitch 2.54mm 90° 三排 DIP H2.54W7.5单塑排针 PA6.0 PC3.0 2x23P 包装图 | | REV: A1 SHEET: 2/2 |
| | | | SIZE: A4 | 0.000±0.10 | X°X' ±2° | DRAWN | LX_HOU | 23.06.13 | | | |