

The product using material and processing must conform to the "WI-PZ-001"HSF technical standard control requirements

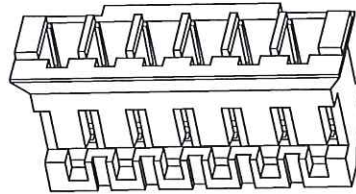

Circuit 1

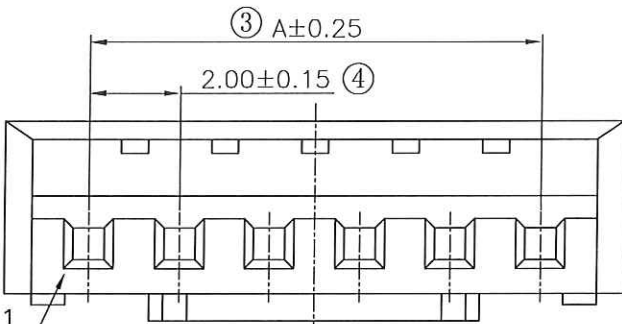
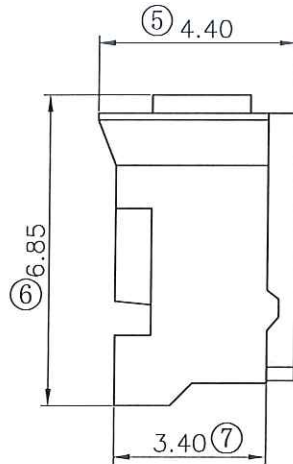
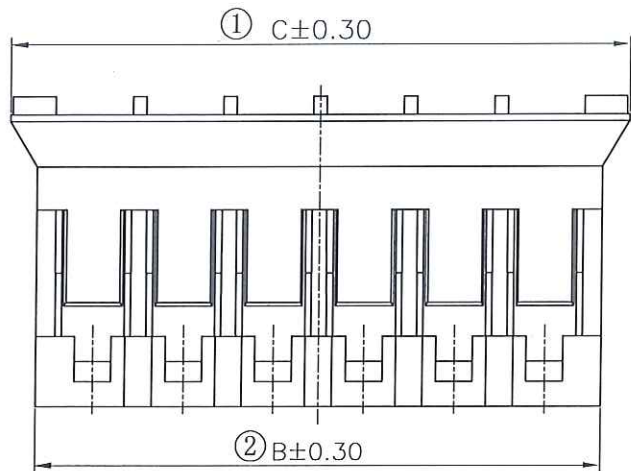
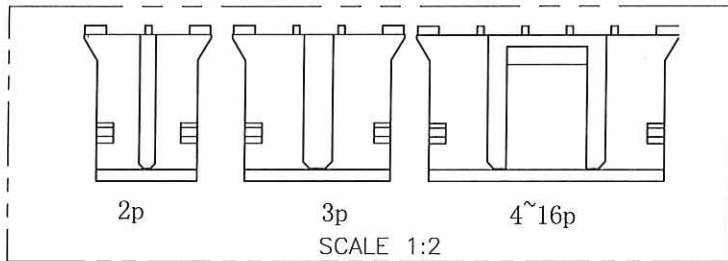

NOTE:

- 1.MATERIAL SPECIFICATION:
1-1.HOUSING: PA66,UL94V-0
- 2.ELECTRICAL PERFORMANCE:
2-1.INSULATION RESISTANCE: 1000MΩ Min
2-2.DIELECTRIC WITHSTANDING : 800V AC
- 3.ENVIRONMENTAL PERFORMANCE:
3-1.OPERATING TEMPERATURE: $-25^{\circ}\text{C} \sim +85^{\circ}\text{C}$.(低温料)
3-2.OPERATING TEMPERATURE: $-40^{\circ}\text{C} \sim +105^{\circ}\text{C}$.(高温料)
- 4.PACKAGE SPEC:
- 5.P/N:

A2001 H 2 M-1 XX X X

SERIES NO: _____
CONNECTOR: _____
H-HOUSING

2-TYPE CODE:2 _____

MALE FEMALE: _____
M-MALE

ROW NO: _____
1-SINGLE ROW

WATER CODE
0-N/A

COLOR:
A-BLACK
K-WHITE(低温料RoHS+HF)
M-BEIGE(高温料RoHS)

PIN Q'PY:
02~16

Circuit	Dimensions(mm)			Circuit	Dimensions(mm)		
	A	B	C		A	B	C
2	2.00	4.50	5.70	10	18.00	20.50	21.70
3	4.00	6.50	7.70	11	20.00	22.50	23.70
4	6.00	8.50	9.70	12	22.00	24.50	25.70
5	8.00	10.50	11.70	13	24.00	26.50	27.70
6	10.00	12.50	13.70	14	26.00	28.50	29.70
7	12.00	14.50	15.70	15	28.00	30.50	31.70
8	14.00	16.50	17.70	16	30.00	32.50	33.70
9	16.00	18.50	19.70				



REV.	REVISION RECORD	DATE	UNIT:mm	GENERAL TOLERANCES		SCALE: 1:1	NAME	DATE	PART.NO:	DWG.NO:	WanLian Technology Co., Ltd
A0	NEW RELEASE	22.03.19		SIZE: A4	LINEAR	ANGLES	APPROVED	梁学译	2024.6.19	A2001H2M-1XXXX	
				0.00±0.25	X'±3'	CHECK	梁林权	2024.6.19	TITLE:		REV: A0
				0.000±0.10	X'X' ±2'	DRAWN	肖雨曦	2024.6.19	Pitch 2.0mm 180° MALE HOUSING		SHEET: 1/2

The product using material and processing must conform to the "WI-PZ-001" HSF technical standard control requirements

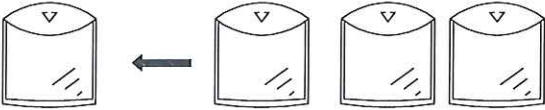

PE袋 1 Pcs

数量 :每袋=0.5~2Kpcs

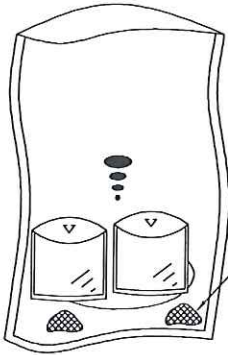

PE防水袋 1 Pcs

干燥剂

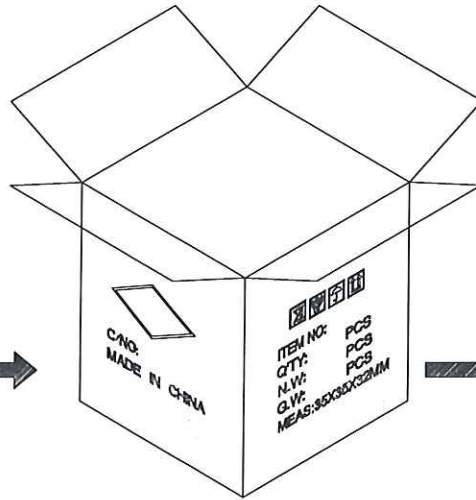

纸箱型号	小型	中型	标准型
高度	7.5	15	32

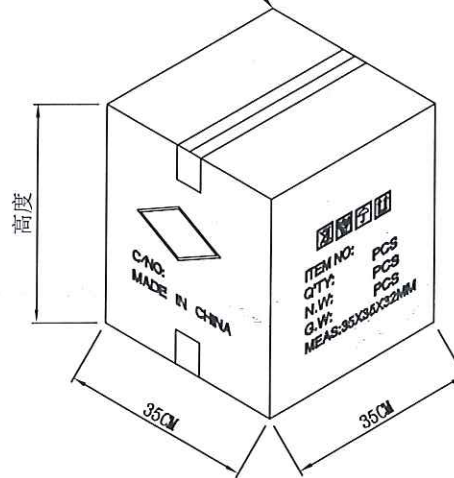

1. 纸箱装箱以不超过装箱线为准, 空余位置用塑料泡沫及保尼龙填充;
2. 纸箱分小、中、标准型3种规格型号: 装箱为整箱采用标准型纸箱包装, 未达到整箱数量以产品量适当采用小型或中型纸箱包装;
3. 因生产Pin位未齐全, 每袋与整箱包装数量仅供参考, 具体包装数量以实际出货为准, 或批量出货更新后为准:



袋装包装数量	
CKT	PCS/BAG
2	2000
3	2000
4	2000
5	2000
6	2000
7	2000
8	2000
9	1000
10	1000
11	1000
12	1000
13	1000
14	1000
15	500
16	500

REV.	REVISION RECORD	DATE		GENERAL TOLERANCES		SCALE: 1:1	NAME	DATE	PART.NO:	DWG.NO:	 WanLian Technology Co., Ltd	
AO	NEW RELEASE			LINEAR	ANGLES	APPROVED	梁学译	2024.6.19	A2001H2M-1XXXX	ENDE05		
			UNIT:mm	0.00±0.25	X'±3'	CHECK	梁林秋	2024.6.19	TITLE:		REV: AO	SHEET: 2/2
			SIZE: A4	0.000±0.10	X'X' ±2'	DRAWN	肖雨晴	2024.6.19	Pitch 2.0mm 180° MALE HOUSING			