

The product using material and processing must conform to the "WI-PZ-001"HSF technical standard control requirements

RoHS+HF

NOTE:

- 1.MATERIAL SPECIFICATION:
 - 1-1.HOUSING: PA46,UL94V-0
- 2.MECHANICAL PERFORMANCE:
 - 2-1.RETENTIVITY FORCE: 0.25kgf/PIN MIN
 - 2-2.DURABILITY: 30 CYCLES.
- 3.ELECTRICAL PERFORMANCE:
 - 3-1.CURRENT RATING: 0.5A
 - RATED VOLTAGE : 30V AC/DC
 - 3-2.CONTACT RESISTANCE: 20 mΩ MAX
 - 3-3.INSULATION RESISTANCE: 100MΩ Min
 - 3-4.DIELECTRIC WITHSTANDING : 200V
- 4.ENVIRONMENTAL PERFORMANCE:
 - 4-1.OPERATING TEMPERATURE: -25°C~+85°C.
- 5.P/N:

D0801 H 2 M-1 XX X 0

SERIES NO: _____

CONNECTOR: _____
H-HOUSING

TYPE CODE: _____

MALE FEMALE: _____
M-MALE

COLOR:
A-BLACK
K-WHITE
S-NATURE

PIN Q'PY:
02~20

ROW NO:
1-SINGLE ROW

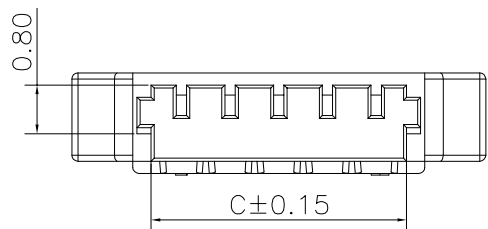
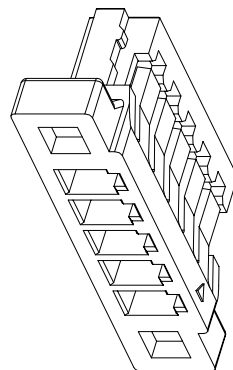
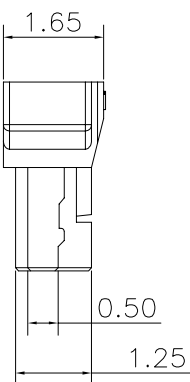
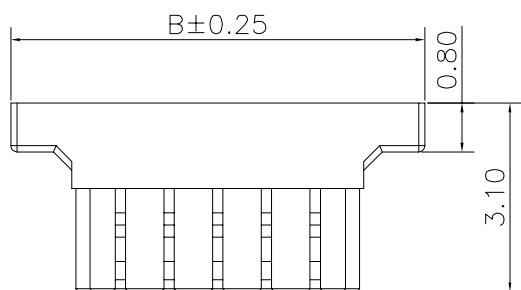
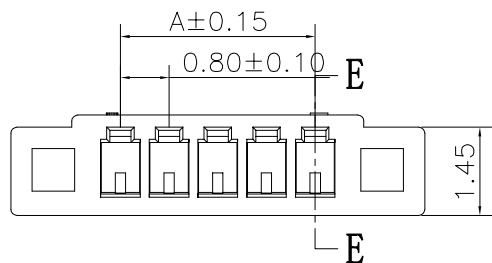
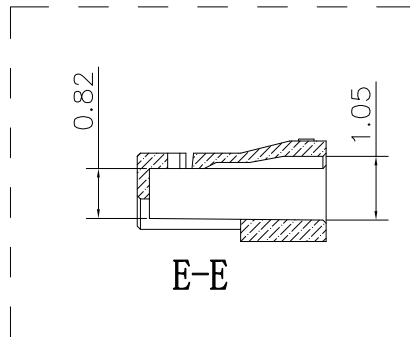
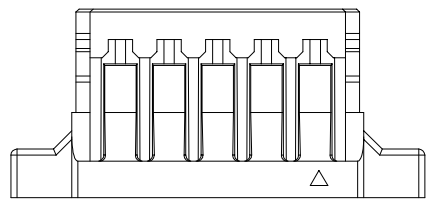

PART NO.	Dimensions			PART NO.	Dimensions		
	A	B	C		A	B	C
02P	0.80	4.40	1.80	12P	8.80	12.40	9.80
03P	1.60	5.20	2.60	13P	9.60	13.20	10.60
04P	2.40	6.00	3.40	14P	10.40	14.00	11.40
05P	3.20	6.80	4.20	15P	11.20	14.80	12.20
06P	4.00	7.60	5.00	16P	12.00	15.60	13.00
07P	4.80	8.40	5.80	17P	12.80	16.40	13.80
08P	5.60	9.20	6.60	18P	13.60	17.20	14.60
09P	6.40	10.00	7.40	19P	14.40	18.00	15.40
10P	7.20	10.80	8.20	20P	15.20	18.80	16.20
11P	8.00	11.60	9.00				

REV.	REVISION RECORD	DATE	UNIT:mm	GENERAL TOLERANCES		SCALE:	NAME	DATE	PART.NO:	DWG.NO:	 WanLian Teconology Co., Ltd
AO	NEW RELEASE	21.10.12		LINEAR	ANGLES	1:1					
			0.00±0.25	X'±3'	APPROVED	Wang_jr	21.10.12	D0801H2M-1XXX0	ENDE05		
			0.00±0.10	X'X' ±2'	DESIGNER	Han_Gao	21.10.12	TITLE:			
			SIZE: A4		DRAWN	Zijun_Huang	21.10.12	Pitch 0.80mm SUH单排有耳 无LOGO Housing		REV: A0	SHEET: 1/1