

The product using material and processing must conform to the "WI-PZ-001" HSF technical standard control requirements

RoHS

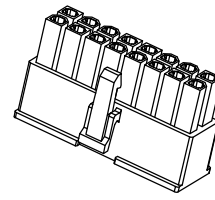
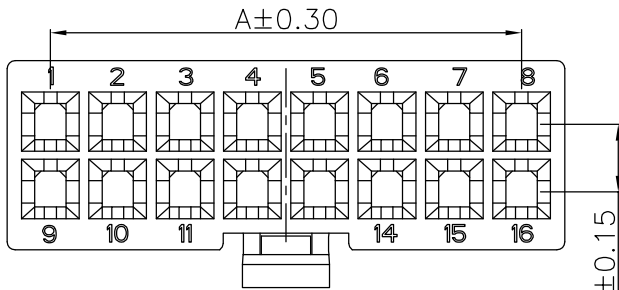

3D view 1/2

NOTE:
 1.MATERIAL SPECIFICATION:
 1-1.HOUSING: PA66
 2.ELECTRICAL PERFORMANCE:
 2-1.INSULATION RESISTANCE: 1000MΩ Min
 2-2.DIELECTRIC WITHSTANDING : 1500V
 3.ENVIRONMENTAL PERFORMANCE:
 3-1.OPERATING TEMPERATURE: -25°C~+85°C.
 4.PACKAGE SPEC: PE BAG
 5.P/N:

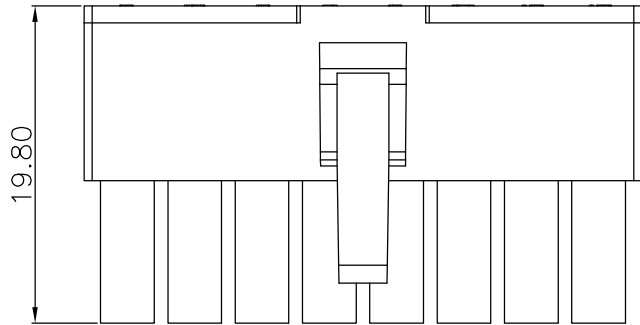

2X2-2X12P

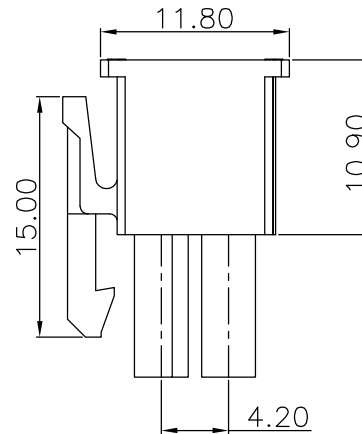

SERIES NO: C4201 H M-2 XX X X
 CONNECTOR: H-HOUSING
 MALE FEMALE: M-MALE
 ROW NO: 2-DOUBLE ROW
 WATER CODE:
 0-UL94V-0
 2-UL94V-2
 3-UL94V-0+HF
 COLOR:
 A-BLACK
 S-NATURE
 PIN Q' PY:
 02~24

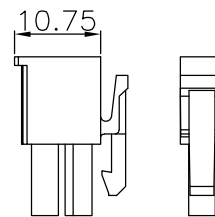
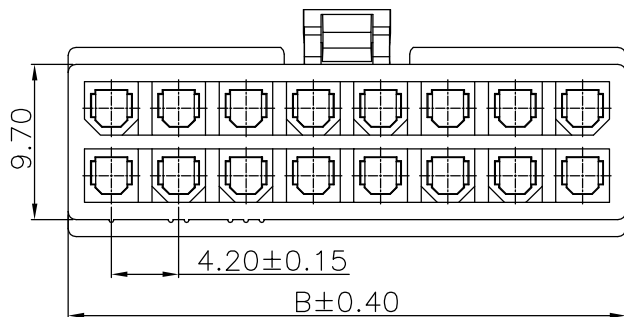

2X1P
1/2

Circuit	Dimensions(mm)		Circuit	Dimensions(mm)	
	A	B		A	B
2*01	---	5.70	2*07	25.20	30.60
2*02	4.20	9.90	2*08	29.40	34.80
2*03	8.40	13.80	2*09	33.60	39.00
2*04	12.60	18.00	2*10	37.80	43.20
2*05	16.80	22.20	2*11	42.00	47.40
2*06	21.00	26.40	2*12	46.20	51.60

REV.	REVISION RECORD	DATE	UNIT:mm	GENERAL TOLERANCES		SCALE:	NAME	DATE	PART.NO:	DWG.NO:	WanLian Technology Co., Ltd
A0	NEW RELEASE	21.11.17		SIZE: A4	LINEAR	ANGLES	1:1	Wang_jr	21.11.17	C4201HM-2XXXX	
				0.00±0.25	X'±3'		Han_Gao	21.11.17	TITLE: Pitch 4.2mm Double Row Male Housing		REV: A0
				0.00±0.35	X*REF±6'		Zijun_Huang	21.11.17			SHEET: 1/3



The product using material and processing must conform to the "WI-PZ-001" HSF technical standard control requirements

RoHS

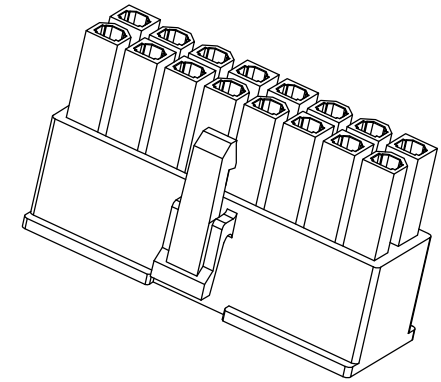
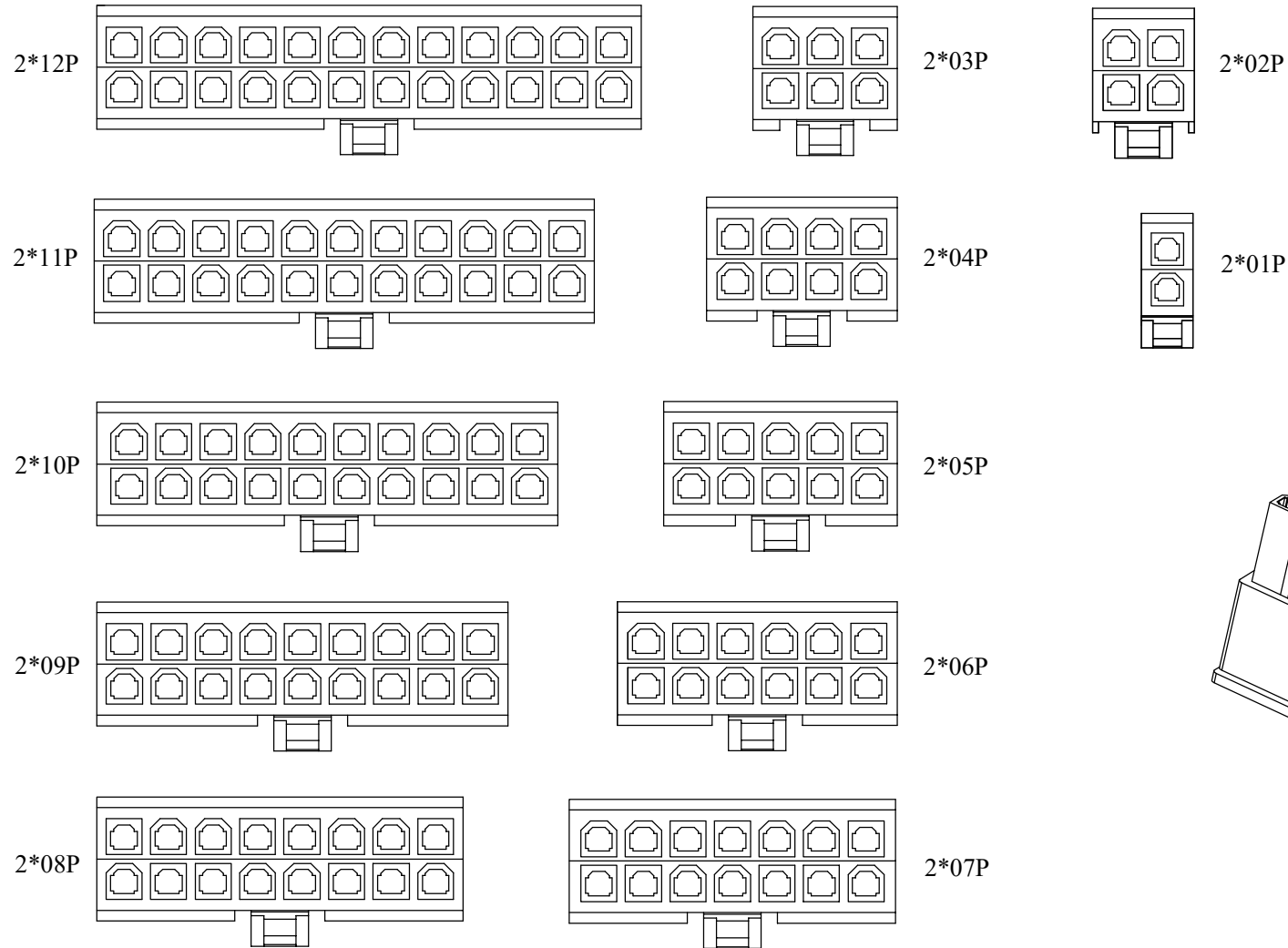

防呆孔位图

REV.	REVISION RECORD	DATE		GENERAL TOLERANCES		SCALE: 1:1	NAME	DATE	PART.NO:	DWG.NO:	 WanLian Technology Co., Ltd
A0	NEW RELEASE	21.11.17		LINEAR	ANGLES	APPROVED	Wang_jr	21.11.17	C4201HM-2XXXX	ENDE05	
			UNIT:mm	0.00±0.25	X'±3'	CHECK	Han_Gao	21.11.17	TITLE:		REV: A0 SHEET: 2/3
			SIZE: A4	0.000±0.10	X'X' ±2'	DRAWN	Zijun_Huang	21.11.17	Pitch 4.2mm Double Row Male Housing		

The product using material and processing must conform to the "WI-PZ-001" HSF technical standard control requirements

RoHS

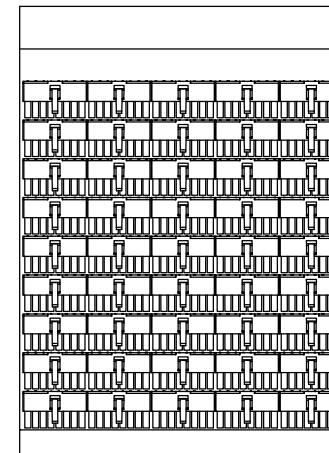
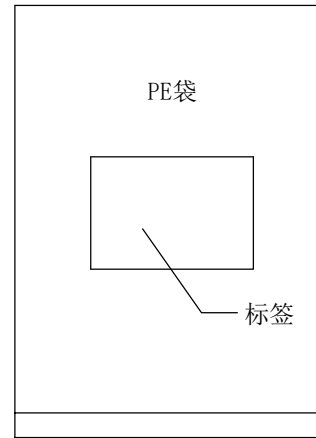
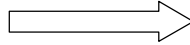
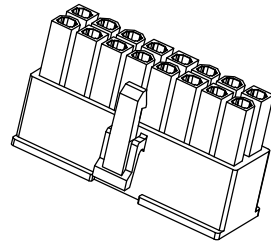

PE袋

标签

外箱

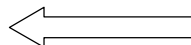
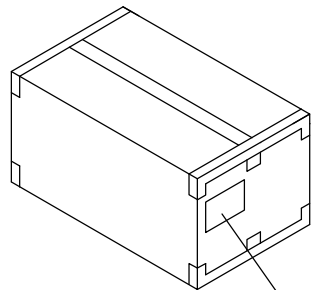

标签

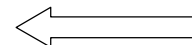
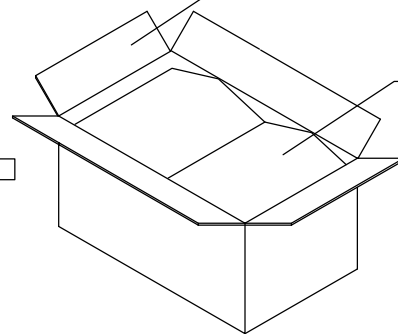

PE袋

纸箱规格:465*315*426MM

注意事项:

1. 产品不可少数、多数;
2. 内外包装均需有数量标签;
3. 不同PIN位包装时须分开放置不可装入同一外箱中。
4. 同一订单尾数包装需用不影响品质之物品填充并注明尾数。

Circuit	Bag Pcs	CARTON Bag	CARTON Pcs
2*1	1K	25	25K
2*2	1K	15	15K
2*3	1K	10	10K
2*4	1K	8	8K
2*5	1K	6	6K
2*6	1K	6	6K
2*7	1K	5	5K
2*8	0.5K	10	5K
2*12	0.25K	10	2.5K

REV.	REVISION RECORD	DATE		GENERAL TOLERANCES		SCALE: 1:1	NAME	DATE	PART.NO: C4201HM-2XXXX	DWG.NO: ENDE05	 WanLian Technology Co., Ltd
AO	NEW RELEASE	21.11.17		LINEAR	ANGLES	APPROVED	Wang_jr	21.11.17			
			UNIT:mm	X'±3'	CHECK	Han_Gao	21.11.17	TITLE: Pitch 4.2mm Double Row Male Housing	REV: A0	SHEET: 3/3	
			SIZE: A4	X'X' ±2'	DRAWN	Zijun_Huang	21.11.17				