

## M-SERIES CIRCULAR CONNECTOR

# M系列圆形连接器

产品手册

Product Brochure



# Company Profile

## 企业简介

广东万连作为业界领先的连接方案提供商，致力于为中国制造业发展提供广泛适用性的连接器产品与技术导向型的定制化服务。

经过17年的技术沉淀，万连科技已获得多项技术认证、国家高新技术企业认证及超150项专利认证，拥有专业的行业实验室以及完整高效的连接器产线，提供从研发、测试到生产的一站式配套服务。

坚持不断追求技术创新，依托超200+工程师团队，实现覆盖消费电子、工业工控、汽车、新能源等多领域，可根据客户的各种个性化需求，快速提供解决方案，满足客户多元化场景连接需求。

未来，我们期待成为最具客户信赖的连接解决方案服务平台，让连接更简单！



### 企业愿景

让连接更简单



### 企业使命

提供标准化、可定制的一站式连接解决方案，为客户降本增效



### 企业理念

以客户为中心，以人为本，  
团结协作，创新高效



# Honors 荣誉资质



## M系列圆形连接器

## M-series circular connector

### M5圆形连接器

|       |         |
|-------|---------|
| 面板式   | 001-007 |
| cable | 008-011 |

### M8圆形连接器

|       |         |
|-------|---------|
| 组装式   | 013-016 |
| 面板式   | 017-032 |
| 成型式   | 033-039 |
| cable | 040-043 |

### M9圆形连接器

|       |         |
|-------|---------|
| 组装式   | 045-048 |
| 面板式   | 049-054 |
| cable | 055-058 |

### M12圆形连接器

|       |         |
|-------|---------|
| 组装式   | 059-064 |
| 面板式   | 065-100 |
| 成型式   | 101-138 |
| cable | 139-142 |

### M16圆形连接器

|       |         |
|-------|---------|
| 组装式   | 143-146 |
| 面板式   | 147-156 |
| cable | 157-160 |

### M23圆形连接器

|     |         |
|-----|---------|
| 组装式 | 161-170 |
|-----|---------|

### 7/8圆形连接器

|     |         |
|-----|---------|
| 面板式 | 171-174 |
|-----|---------|

## M系列圆形连接器编码原则

## Coding principles for circular M-series connectors

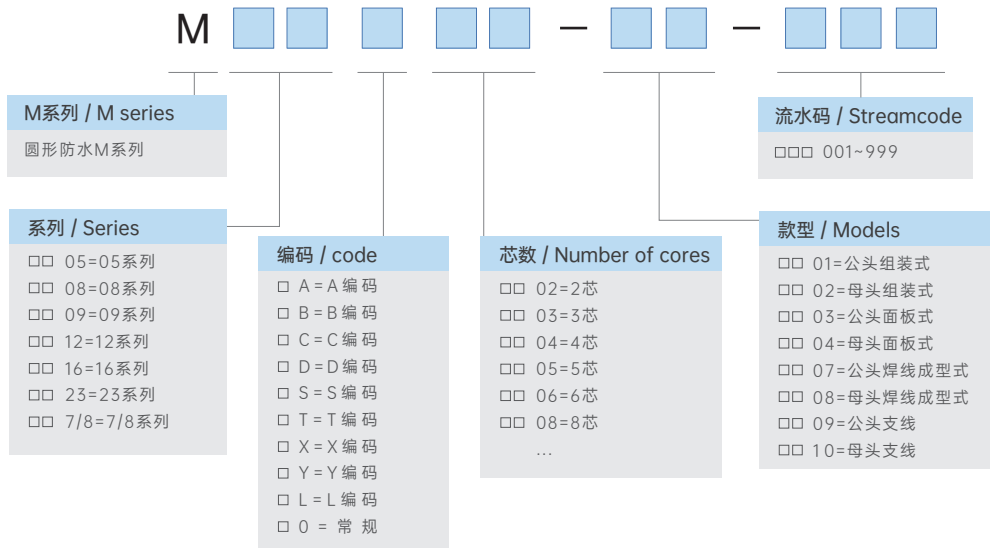

示例：M8组装式连接器

料号：M08A03-01-010：表示M8圆形连接器A编码 3PIN 公头组装式

## M系列圆形线束编码规则

## Circular M-series wiring harness coding rules

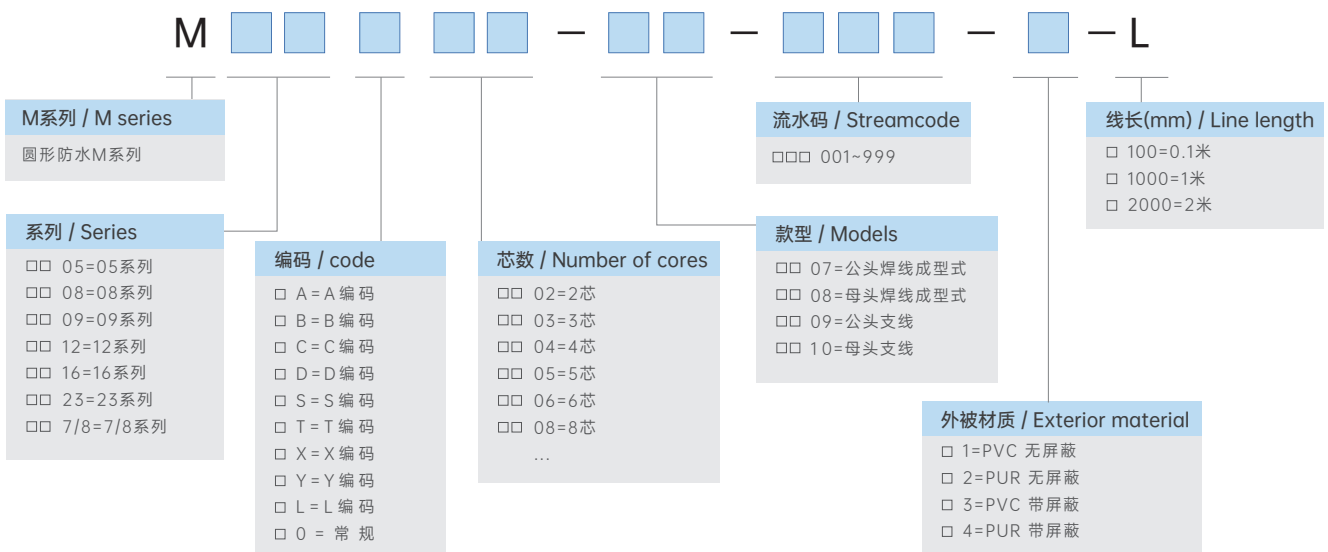

示例：M12圆形连接器成型式线束

M12A05-10-010-3-L :表示M12直头孔式成型电缆插头线束 A编码5PIN母头支线,PVC外被线缆屏蔽款, L线长可定制

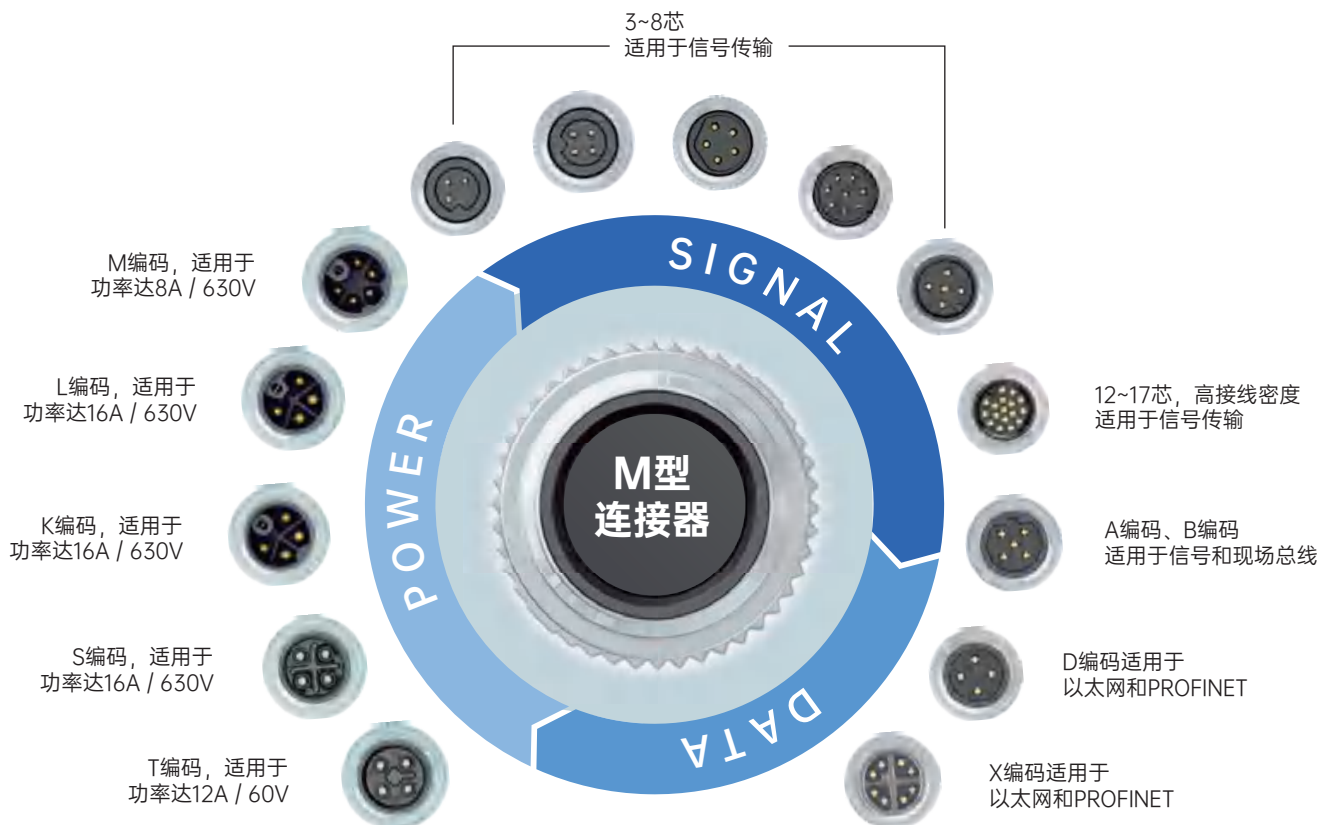

## M型连接器编码含义

## Meaning of M-type connector coding

### A编码

适用于传感器、执行器、IO-Link 设备和外围设备，通常有2-17芯连接器可选；支持1 Gbps以太网连接信号传输，也适用于直流电源连接。

### B编码

适用于控制系统或现场总线Profibus和Interbus通信协议，通常是5芯连接器；适用于工业自动化领域的特定通信需求。

### C编码

适用于交流电源连接，一般有3到6芯连接器可选；在需要交流电源供电的传感器和执行器场合中使用，可由S编码连接器代替。

### D编码

支持100 Mbit以太网连接，连接器为4芯，通常与CAT5e电缆一起使用；适用于需要中等速率的工业以太网（PROFINET）、轨道交通CCTV控制系统、及伺服、编码器 etc 场合。

### X编码

专为高速数据传输而设计，支持高达10 Gbps的高速千兆以太网传输连接，连接器通常为8芯；适用于在需要高速数据传输的工业通信与工业网络布线，视频监控及其它需要高速以太网传输方案领域。

## K编码

适用于对交流电连接特殊需求的连接应用，特殊5芯结构可同时传输控制信号、状态信息及电源信号；同时为工业自动化严苛应用环境（如高温、高湿、强振动）提供小尺寸、大电流、高电压、IP67/IP68高防护等级的连接方案，让连接更精密可靠。

## L编码

适用于高功率传输的工业设备的电源连接，如PROFINET系统组件、电源供应单元等；为工业自动化严苛应用环境提供小尺寸、大电流、IP67/IP68高防护等级的连接方案，让连接更精密灵活

## S编码

专为AC交流电源连接设计，连接器具有良好的屏蔽性能和防护等级，能够满足工业自动化领域对电源连接器的高要求；主要应用于自动化电气电子设备交流电源连接，可替换C编码电力部件。

## T编码

专为DC直流电源连接设计，连接器具有高可靠性、IP67及以上防水性能和广泛的适用性，主要应用于需要直流电源连接的工业自动化设备，可替换A编码电力部件。

## M型连接器编码的作用

## The role of M-type connector coding

### 防止错误配合

M型连接器的编码设计有助于防止错误配合，确保连接器只能与具有相同编码的插座或插头配对使用，这种设计完美解决了连接器误插、盲插或错插而导致操作失误问题，有效防止设备故障或损坏，提高作业的安全性。

### 提供屏蔽保护

大多数编码的M型连接器都提供屏蔽保护，以减少电磁干扰和射频干扰（EMI/RFI），确保数据传输的稳定性和可靠性。

### 标识电气特性

编码能够清晰地标识连接器的电气特性，如支持的以太网速率、电源类型等，便于用户在选择和使用连接器时做出正确的决策。



目前，A、B、D、X编码是M型连接器中最受欢迎的编码类型，其中，A编码适用于通用传感器和编码器的连接；B编码专为Profibus应用设计；D编码则适合高传输速度及高防护级别的通讯需求；而X编码正逐渐成为未来高速工业以太网领域的首选，并有望取代现有的A编码与D编码。凭借其卓越的物理性能和稳定的信号传输能力，M型连接器已在多个行业中得到了广泛应用。用户可以根据具体的应用场景和个人需求来选择最合适的编码类型。

作为专业的圆形连接器制造商，电子谷提供多种编码类型的M型圆形连接器解决方案，确保您的设备能够在各种工业环境下实现可靠且高效的信号、数据以及电力传输。

## M5前锁面板式公头插座 焊线型

产品图 / Product photo



尺寸图 / Dimension

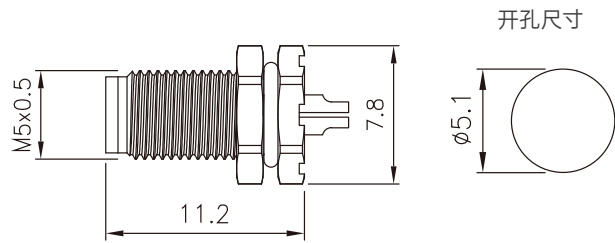

针位分布前视图 / Pin assignment front view

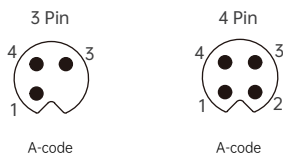

订货信息 / Order daea

| 芯数 / Number of cores | Coding | 料号 / Part number |
|----------------------|--------|------------------|
| 03 Pin               | A-code | M05A03-03-003    |
| 04 Pin               | A-code | M05A04-03-003    |

技术参数 / Specifications

| 芯数 / Pin   | 03 Pin  | 04 Pin |
|--|---|--------|
| 额定电流 / Rated current                                 | 1 A   |        |
| 额定电压 / Rated voltage                                 | A/C (交流) : 60 V D/C (直流) : 60 V                                       |        |
| 线规 (mm <sup>2</sup> ) / Wire gauge(mm <sup>2</sup> ) | 0.14mm <sup>2</sup>   |        |
| 线号 (AWG) / Wire gauge(AWG)                           | 26AWG   |        |
| 壳体材料 / Outer shell material                          | 铜合金 / Copper Alloy  |        |
| 胶芯材料 / Housing material                              | 尼龙PA66  |        |
| 成型材料 / Molding material                              | PVC/TPU   |        |
| 端子材料 / Pin material                                  | 黄铜镀金/磷铜镀金 / Brass With Gold Plated / Phosphor Bronze With Gold Plated |        |
| 适用温度 / Applicable temperature                        | -20 °C ~ +80 °C   |        |
| 绝缘电阻 / Insulation resistance                         | ≥ 100MΩ   |        |
| 接触电阻 / Contact resistance                            | ≤ 3mΩ   |        |
| 防护等级 / Degree of protection                          | IP67  |        |
| 插拔次数 / Mechanical durability                         | ≥ 500次  |        |
| 线材 / Wire rod  | PVC/PUR   |        |



## M5前锁面板式母头插座 焊线型

产品图 / Product photo



尺寸图 / Dimension

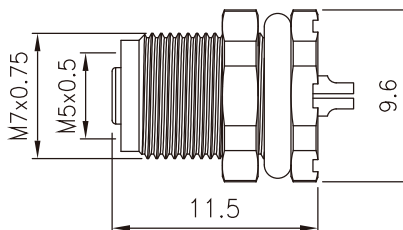

针位分布前视图 / Pin assignment front view

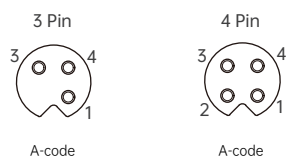

订货信息 / Order daec

| 芯数 / Number of cores | Coding | 料号 / Part number |
|----------------------|--------|------------------|
| 03 Pin               | A-code | M05A03-04-003    |
| 04 Pin               | A-code | M05A04-04-003    |

技术参数 / Specifications

| 芯数 / Pin   | 03 Pin  | 04 Pin |
|--|---|--------|
| 额定电流 / Rated current                                 | 1 A   |        |
| 额定电压 / Rated voltage                                 | A/C (交流) : 60 V D/C (直流) : 60 V                                       |        |
| 线规 (mm <sup>2</sup> ) / Wire gauge(mm <sup>2</sup> ) | 0.14mm <sup>2</sup>   |        |
| 线号 (AWG) / Wire gauge(AWG)                           | 26AWG   |        |
| 壳体材料 / Outer shell material                          | 铜合金 / Copper Alloy  |        |
| 胶芯材料 / Housing material                              | 尼龙PA66  |        |
| 成型材料 / Molding material                              | PVC/TPU   |        |
| 端子材料 / Pin material                                  | 黄铜镀金/磷铜镀金 / Brass With Gold Plated / Phosphor Bronze With Gold Plated |        |
| 适用温度 / Applicable temperature                        | -20 °C ~ +80 °C   |        |
| 绝缘电阻 / Insulation resistance                         | ≥ 100MΩ   |        |
| 接触电阻 / Contact resistance                            | ≤ 3mΩ   |        |
| 防护等级 / Degree of protection                          | IP67  |        |
| 插拔次数 / Mechanical durability                         | ≥ 500次  |        |
| 线材 / Wire rod  | PVC/PUR   |        |

## M5前锁面板式公头插座 焊板型

产品图 / Product photo



尺寸图 / Dimension

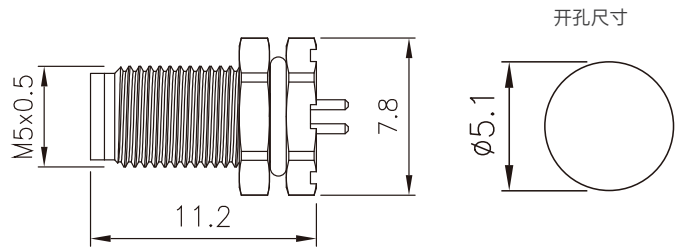

针位分布前视图 / Pin assignment front view

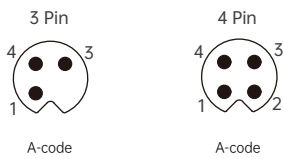

PCB芯位图 / PCB core diagram

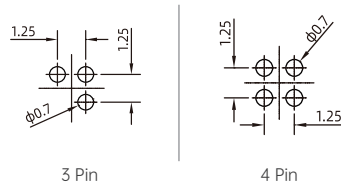

订货信息 / Order daec

| 芯数 / Number of cores | Coding | 料号 / Part number |
|----------------------|--------|------------------|
| 03 Pin               | A-code | M05A03-03-004    |
| 04 Pin               | A-code | M05A04-03-004    |

技术参数 / Specifications

| 芯数 / Pin   | 03 Pin  | 04 Pin |
|--|---|--------|
| 额定电流 / Rated current                                 | 1 A   |        |
| 额定电压 / Rated voltage                                 | A/C (交流) : 60 V D/C (直流) : 60 V                                       |        |
| 线规 (mm <sup>2</sup> ) / Wire gauge(mm <sup>2</sup> ) | 0.14mm <sup>2</sup>   |        |
| 线号 (AWG) / Wire gauge(AWG)                           | 26AWG   |        |
| 壳体材料 / Outer shell material                          | 铜合金 / Copper Alloy  |        |
| 胶芯材料 / Housing material                              | 尼龙PA66  |        |
| 成型材料 / Molding material                              | PVC/TPU   |        |
| 端子材料 / Pin material                                  | 黄铜镀金/磷铜镀金 / Brass With Gold Plated / Phosphor Bronze With Gold Plated |        |
| 适用温度 / Applicable temperature                        | -20 °C ~ +80 °C   |        |
| 绝缘电阻 / Insulation resistance                         | ≥ 100MΩ   |        |
| 接触电阻 / Contact resistance                            | ≤ 3mΩ   |        |
| 防护等级 / Degree of protection                          | IP67  |        |
| 插拔次数 / Mechanical durability                         | ≥ 500次  |        |
| 线材 / Wire rod  | PVC/PUR   |        |

## M5前锁面板式母头插座 焊板型

产品图 / Product photo



尺寸图 / Dimension

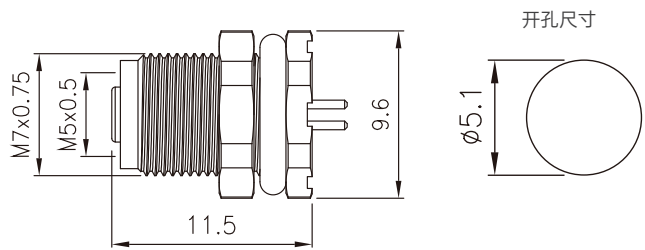

针位分布前视图 / Pin assignment front view

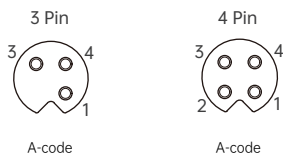

PCB芯位图 / PCB core diagram

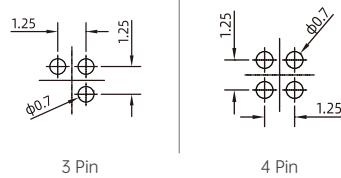

订货信息 / Order daec

| 芯数 / Number of cores | Coding | 料号 / Part number |
|----------------------|--------|------------------|
| 03 Pin               | A-code | M05A03-04-004    |
| 04 Pin               | A-code | M05A04-04-004    |

技术参数 / Specifications

| 芯数 / Pin   | 03 Pin  | 04 Pin |
|--|---|--------|
| 额定电流 / Rated current                                 | 1 A   |        |
| 额定电压 / Rated voltage                                 | A/C (交流) : 60 V D/C (直流) : 60 V                                       |        |
| 线规 (mm <sup>2</sup> ) / Wire gauge(mm <sup>2</sup> ) | 0.14mm <sup>2</sup>   |        |
| 线号 (AWG) / Wire gauge(AWG)                           | 26AWG   |        |
| 壳体材料 / Outer shell material                          | 铜合金 / Copper Alloy  |        |
| 胶芯材料 / Housing material                              | 尼龙PA66  |        |
| 成型材料 / Molding material                              | PVC/TPU   |        |
| 端子材料 / Pin material                                  | 黄铜镀金/磷铜镀金 / Brass With Gold Plated / Phosphor Bronze With Gold Plated |        |
| 适用温度 / Applicable temperature                        | -20 °C ~ +80 °C   |        |
| 绝缘电阻 / Insulation resistance                         | ≥ 100MΩ   |        |
| 接触电阻 / Contact resistance                            | ≤ 3mΩ   |        |
| 防护等级 / Degree of protection                          | IP67  |        |
| 插拔次数 / Mechanical durability                         | ≥ 500次  |        |
| 线材 / Wire rod  | PVC/PUR   |        |

## M5后锁面板式公头插座 焊线型

产品图 / Product photo



尺寸图 / Dimension

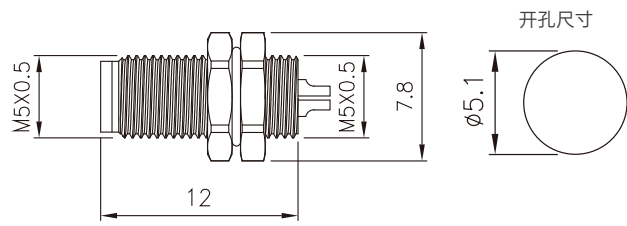

针位分布前视图 / Pin assignment front view

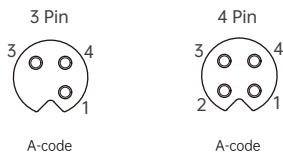

PCB芯位图 / PCB core diagram

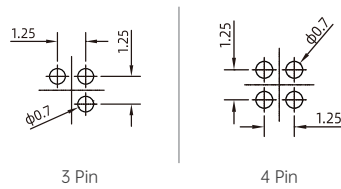

订货信息 / Order daec

| 芯数 / Number of cores | Coding | 料号 / Part number |
|----------------------|--------|------------------|
| 03 Pin               | A-code | M05A03-03-001    |
| 04 Pin               | A-code | M05A04-03-001    |

技术参数 / Specifications

| 芯数 / Pin   | 03 Pin  | 04 Pin |
|--|---|--------|
| 额定电流 / Rated current                                 | 1 A   |        |
| 额定电压 / Rated voltage                                 | A/C (交流) : 60 V D/C (直流) : 60 V                                       |        |
| 线规 (mm <sup>2</sup> ) / Wire gauge(mm <sup>2</sup> ) | 0.14mm <sup>2</sup>   |        |
| 线号 (AWG) / Wire gauge(AWG)                           | 26AWG   |        |
| 壳体材料 / Outer shell material                          | 铜合金 / Copper Alloy  |        |
| 胶芯材料 / Housing material                              | 尼龙PA66  |        |
| 成型材料 / Molding material                              | PVC/TPU   |        |
| 端子材料 / Pin material                                  | 黄铜镀金/磷铜镀金 / Brass With Gold Plated / Phosphor Bronze With Gold Plated |        |
| 适用温度 / Applicable temperature                        | -20 °C ~ +80 °C   |        |
| 绝缘电阻 / Insulation resistance                         | ≥ 100MΩ   |        |
| 接触电阻 / Contact resistance                            | ≤ 3mΩ   |        |
| 防护等级 / Degree of protection                          | IP67  |        |
| 插拔次数 / Mechanical durability                         | ≥ 500次  |        |
| 线材 / Wire rod  | PVC/PUR   |        |

## M5后锁面板式母头插座 焊线型

产品图 / Product photo



尺寸图 / Dimension

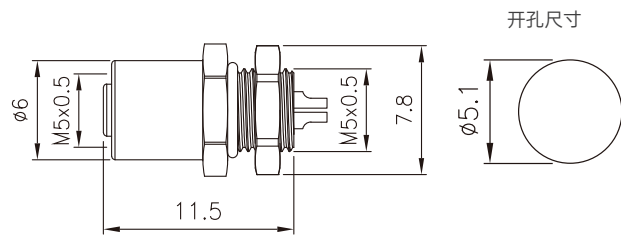

针位分布前视图 / Pin assignment front view

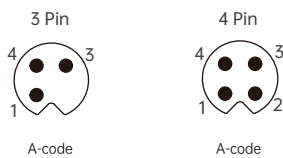

订货信息 / Order daec

| 芯数 / Number of cores | Coding | 料号 / Part number |
|----------------------|--------|------------------|
| 03 Pin               | A-code | M05A04-04-001    |
| 04 Pin               | A-code | M05A04-04-001    |

技术参数 / Specifications

| 芯数 / Pin   | 03 Pin  | 04 Pin |
|--|---|--------|
| 额定电流 / Rated current                                 | 1 A   |        |
| 额定电压 / Rated voltage                                 | A/C (交流) : 60 V D/C (直流) : 60 V                                       |        |
| 线规 (mm <sup>2</sup> ) / Wire gauge(mm <sup>2</sup> ) | 0.14mm <sup>2</sup>   |        |
| 线号 (AWG) / Wire gauge(AWG)                           | 26AWG   |        |
| 壳体材料 / Outer shell material                          | 铜合金 / Copper Alloy  |        |
| 胶芯材料 / Housing material                              | 尼龙PA66  |        |
| 成型材料 / Molding material                              | PVC/TPU   |        |
| 端子材料 / Pin material                                  | 黄铜镀金/磷铜镀金 / Brass With Gold Plated / Phosphor Bronze With Gold Plated |        |
| 适用温度 / Applicable temperature                        | -20 °C ~ +80 °C   |        |
| 绝缘电阻 / Insulation resistance                         | ≥ 100MΩ   |        |
| 接触电阻 / Contact resistance                            | ≤ 3mΩ   |        |
| 防护等级 / Degree of protection                          | IP67  |        |
| 插拔次数 / Mechanical durability                         | ≥ 500次  |        |
| 线材 / Wire rod  | PVC/PUR   |        |

## M5后锁面板式母头插座 焊板型

产品图 / Product photo



尺寸图 / Dimension

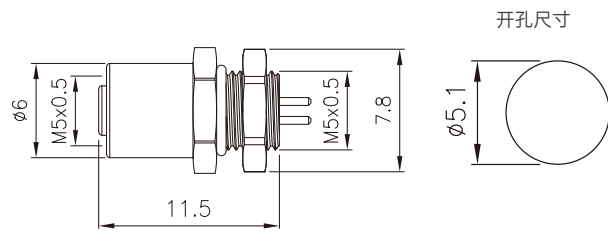

针位分布前视图 / Pin assignment front view

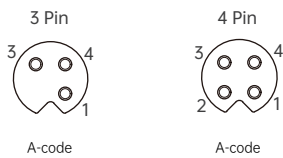

PCB芯位图 / PCB core diagram

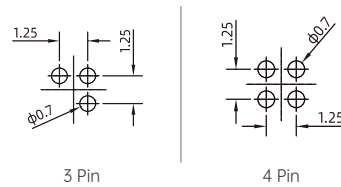

订货信息 / Order daec

| 芯数 / Number of cores | Coding | 料号 / Part number |
|----------------------|--------|------------------|
| 03 Pin               | A-code | M05A03-04-002    |
| 04 Pin               | A-code | M05A04-04-002    |

技术参数 / Specifications

| 芯数 / Pin   | 03 Pin  | 04 Pin |
|--|---|--------|
| 额定电流 / Rated current                                 | 1 A   |        |
| 额定电压 / Rated voltage                                 | A/C (交流) : 60 V D/C (直流) : 60 V                                       |        |
| 线规 (mm <sup>2</sup> ) / Wire gauge(mm <sup>2</sup> ) | 0.14mm <sup>2</sup>   |        |
| 线号 (AWG) / Wire gauge(AWG)                           | 26AWG   |        |
| 壳体材料 / Outer shell material                          | 铜合金 / Copper Alloy  |        |
| 胶芯材料 / Housing material                              | 尼龙PA66  |        |
| 成型材料 / Molding material                              | PVC/TPU   |        |
| 端子材料 / Pin material                                  | 黄铜镀金/磷铜镀金 / Brass With Gold Plated / Phosphor Bronze With Gold Plated |        |
| 适用温度 / Applicable temperature                        | -20 °C ~ +80 °C   |        |
| 绝缘电阻 / Insulation resistance                         | ≥ 100MΩ   |        |
| 接触电阻 / Contact resistance                            | ≤ 3mΩ   |        |
| 防护等级 / Degree of protection                          | IP67  |        |
| 插拔次数 / Mechanical durability                         | ≥ 500次  |        |
| 线材 / Wire rod  | PVC/PUR   |        |

## M5公直头成型式线束 屏蔽/非屏蔽 线长L可定制

产品图 / Product photo



尺寸图 / Dimension

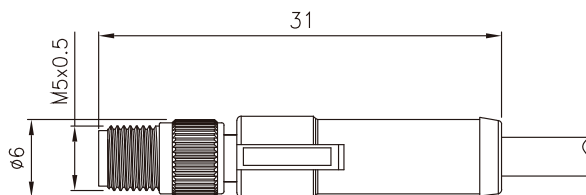

针位分布前视图 / Pin assignment front view

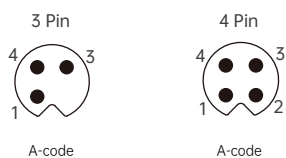

订货信息 / Order daea

| 芯数 / Contacts | 编码 / Code | 产品料号("L"表示长度, 单位毫米mm) / Part number ("L" is length millimetre mm) |                   |                   |                   |
|---------------|-----------|---|-------------------|-------------------|-------------------|
|               |           | 1: PVC 无屏蔽  | 2: PUR 无屏蔽        | 3: PVC 带屏蔽        | 4: PUR 带屏蔽        |
| 03 Pin        | A-code    | M05A03-09-010-1-L   | M05A03-09-010-2-L | M05A03-09-010-3-L | M05A03-09-010-4-L |
| 04 Pin        | A-code    | M05A04-09-010-1-L   | M05A04-09-010-2-L | M05A04-09-010-3-L | M05A04-09-010-4-L |

技术参数 / Specifications

| 芯数 / Pin   | 03 Pin  | 04 Pin |
|--|---|--------|
| 额定电流 / Rated current                                 | 1 A   |        |
| 额定电压 / Rated voltage                                 | A/C (交流) : 60 V D/C (直流) : 60 V                                       |        |
| 线规 (mm <sup>2</sup> ) / Wire gauge(mm <sup>2</sup> ) | 0.14mm <sup>2</sup>   |        |
| 线号 (AWG) / Wire gauge(AWG)                           | 26AWG   |        |
| 壳体材料 / Outer shell material                          | 铜合金 / Copper Alloy  |        |
| 胶芯材料 / Housing material                              | 尼龙PA66  |        |
| 成型材料 / Molding material                              | PVC/TPU   |        |
| 端子材料 / Pin material                                  | 黄铜镀金/磷铜镀金 / Brass With Gold Plated / Phosphor Bronze With Gold Plated |        |
| 适用温度 / Applicable temperature                        | -20 °C ~ +80 °C   |        |
| 绝缘电阻 / Insulation resistance                         | ≥ 100MΩ   |        |
| 接触电阻 / Contact resistance                            | ≤ 3mΩ   |        |
| 防护等级 / Degree of protection                          | IP67  |        |
| 插拔次数 / Mechanical durability                         | ≥ 500次  |        |
| 线材 / Wire rod  | PVC/PUR   |        |

## M5母直头成型式线束 屏蔽/非屏蔽 线长L可定制

产品图 / Product photo



尺寸图 / Dimension

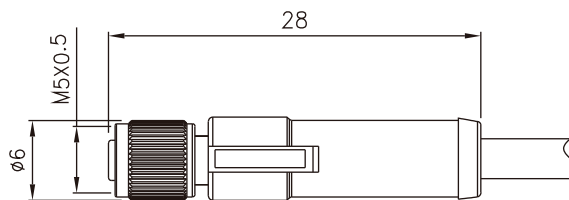

针位分布前视图 / Pin assignment front view

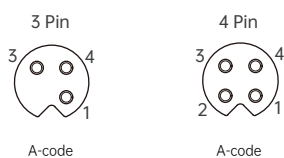

订货信息 / Order daea

| 芯数 / Contacts | 编码 / Code | 产品料号("L"表示长度, 单位毫米mm) / Part number ("L" is length millimetre mm) |                   |                   |                   |
|---------------|-----------|---|-------------------|-------------------|-------------------|
|               |           | 1: PVC 无屏蔽  | 2: PUR 无屏蔽        | 3: PVC 带屏蔽        | 4: PUR 带屏蔽        |
| 03 Pin        | A-code    | M05A03-10-010-1-L   | M05A03-10-010-2-L | M05A03-10-010-3-L | M05A03-10-010-4-L |
| 04 Pin        | A-code    | M05A04-10-010-1-L   | M05A04-10-010-2-L | M05A04-10-010-3-L | M05A04-10-010-4-L |

技术参数 / Specifications

| 芯数 / Pin   | 03 Pin  | 04 Pin |
|--|---|--------|
| 额定电流 / Rated current                                 | 1 A   |        |
| 额定电压 / Rated voltage                                 | A/C (交流) : 60 V D/C (直流) : 60 V                                       |        |
| 线规 (mm <sup>2</sup> ) / Wire gauge(mm <sup>2</sup> ) | 0.14mm <sup>2</sup>   |        |
| 线号 (AWG) / Wire gauge(AWG)                           | 26AWG   |        |
| 壳体材料 / Outer shell material                          | 铜合金 / Copper Alloy  |        |
| 胶芯材料 / Housing material                              | 尼龙PA66  |        |
| 成型材料 / Molding material                              | PVC/TPU   |        |
| 端子材料 / Pin material                                  | 黄铜镀金/磷铜镀金 / Brass With Gold Plated / Phosphor Bronze With Gold Plated |        |
| 适用温度 / Applicable temperature                        | -20 °C ~ +80 °C   |        |
| 绝缘电阻 / Insulation resistance                         | ≥ 100MΩ   |        |
| 接触电阻 / Contact resistance                            | ≤ 3mΩ   |        |
| 防护等级 / Degree of protection                          | IP67  |        |
| 插拔次数 / Mechanical durability                         | ≥ 500次  |        |
| 线材 / Wire rod  | PVC/PUR   |        |



## M5公弯头成型式线束 屏蔽/非屏蔽 线长L可定制

产品图 / Product photo



尺寸图 / Dimension

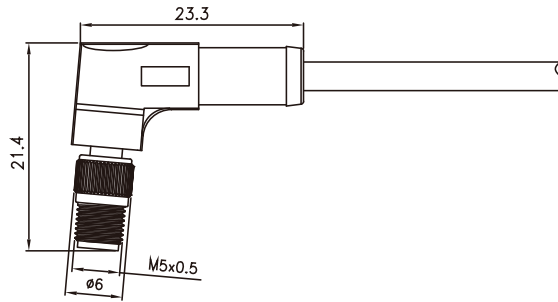

针位分布前视图 / Pin assignment front view

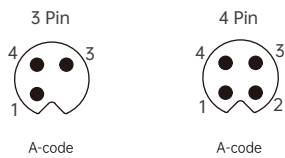

订货信息 / Order daea

| 芯数 / Contacts | 编码 / Code | 产品料号("L"表示长度, 单位毫米mm) / Part number ("L" is length millimetre mm) |                   |                   |                   |
|---------------|-----------|---|-------------------|-------------------|-------------------|
|               |           | 1: PVC 无屏蔽  | 2: PUR 无屏蔽        | 3: PVC 带屏蔽        | 4: PUR 带屏蔽        |
| 03 Pin        | A-code    | M05A03-09-011-1-L   | M05A03-09-011-2-L | M05A03-09-011-3-L | M05A03-09-011-4-L |
| 04 Pin        | A-code    | M05A04-09-011-1-L   | M05A04-09-011-2-L | M05A04-09-011-3-L | M05A04-09-011-4-L |

技术参数 / Specifications

| 芯数 / Pin   | 03 Pin  | 04 Pin |
|--|---|--------|
| 额定电流 / Rated current                                 | 1 A   |        |
| 额定电压 / Rated voltage                                 | A/C (交流) : 60 V D/C (直流) : 60 V                                       |        |
| 线规 (mm <sup>2</sup> ) / Wire gauge(mm <sup>2</sup> ) | 0.14mm <sup>2</sup>   |        |
| 线号 (AWG) / Wire gauge(AWG)                           | 26AWG   |        |
| 壳体材料 / Outer shell material                          | 铜合金 / Copper Alloy  |        |
| 胶芯材料 / Housing material                              | 尼龙PA66  |        |
| 成型材料 / Molding material                              | PVC/TPU   |        |
| 端子材料 / Pin material                                  | 黄铜镀金/磷铜镀金 / Brass With Gold Plated / Phosphor Bronze With Gold Plated |        |
| 适用温度 / Applicable temperature                        | -20 °C ~ +80 °C   |        |
| 绝缘电阻 / Insulation resistance                         | ≥ 100MΩ   |        |
| 接触电阻 / Contact resistance                            | ≤ 3mΩ   |        |
| 防护等级 / Degree of protection                          | IP67  |        |
| 插拔次数 / Mechanical durability                         | ≥ 500次  |        |
| 线材 / Wire rod  | PVC/PUR   |        |

## M5母弯头成型式线束 屏蔽/非屏蔽 线长L可定制

产品图 / Product photo



尺寸图 / Dimension

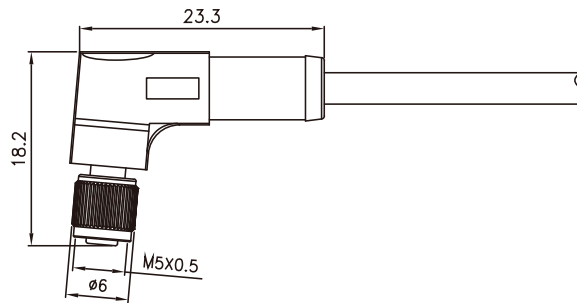

针位分布前视图 / Pin assignment front view

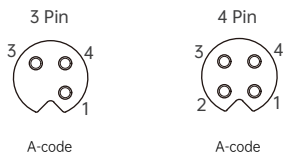

订货信息 / Order daea

| 芯数 / Contacts | 编码 / Code | 产品料号("L"表示长度, 单位毫米mm) / Part number ("L" is length millimetre mm) |                   |                   |                   |
|---------------|-----------|---|-------------------|-------------------|-------------------|
|               |           | 1: PVC 无屏蔽  | 2: PUR 无屏蔽        | 3: PVC 带屏蔽        | 4: PUR 带屏蔽        |
| 03 Pin        | A-code    | M05A03-10-011-1-L   | M05A03-10-011-2-L | M05A03-10-011-3-L | M05A03-10-011-4-L |
| 04 Pin        | A-code    | M05A04-10-011-1-L   | M05A04-10-011-2-L | M05A04-10-011-3-L | M05A04-10-011-4-L |

技术参数 / Specifications

| 芯数 / Pin   | 03 Pin  | 04 Pin |
|--|---|--------|
| 额定电流 / Rated current                                 | 1 A   |        |
| 额定电压 / Rated voltage                                 | A/C (交流) : 60 V D/C (直流) : 60 V                                       |        |
| 线规 (mm <sup>2</sup> ) / Wire gauge(mm <sup>2</sup> ) | 0.14mm <sup>2</sup>   |        |
| 线号 (AWG) / Wire gauge(AWG)                           | 26AWG   |        |
| 壳体材料 / Outer shell material                          | 铜合金 / Copper Alloy  |        |
| 胶芯材料 / Housing material                              | 尼龙PA66  |        |
| 成型材料 / Molding material                              | PVC/TPU   |        |
| 端子材料 / Pin material                                  | 黄铜镀金/磷铜镀金 / Brass With Gold Plated / Phosphor Bronze With Gold Plated |        |
| 适用温度 / Applicable temperature                        | -20 °C ~ +80 °C   |        |
| 绝缘电阻 / Insulation resistance                         | ≥ 100MΩ   |        |
| 接触电阻 / Contact resistance                            | ≤ 3mΩ   |        |
| 防护等级 / Degree of protection                          | IP67  |        |
| 插拔次数 / Mechanical durability                         | ≥ 500次  |        |
| 线材 / Wire rod  | PVC/PUR   |        |



## M8公直头塑胶组装式插头 螺钉压接

产品图 / Product photo



尺寸图 / Dimension

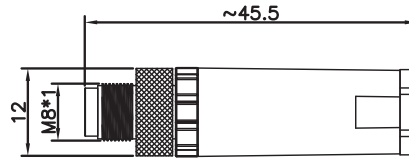

针位分布前视图 / Pin assignment front view

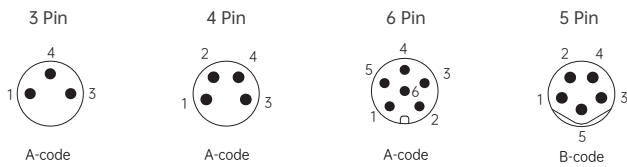

订货信息 / Order daec

| 芯数 / Number of cores | Coding | 料号 / Part number | Qty      |
|----------------------|--------|------------------|----------|
| 03 Pin               | A-code | M08A03-01-010    | 1000 pcs |
| 04 Pin               | A-code | M08A04-01-010    | 1000 pcs |
| 05 Pin               | B-code | M08B05-01-010    | 1000 pcs |
| 06 Pin               | A-code | M08A06-01-010    | 1000 pcs |

技术参数 / Specifications

| 芯数 / Pin                         | 03 Pin                          | 04 Pin | 05 Pin | 06 Pin |
|----------------------------------|---------------------------------|--------|--------|--------|
| 额定电流 / Rated current             | 3 A                             | 3 A    | 3 A    | 1 A    |
| 额定电压 / Rated voltage             | 60 V                            | 30 V   | 30 V   | 30 V   |
| 标准 / Standard                    | IEC 61076-2-104                 |        |        |        |
| 接线方式 / Termination               | 螺钉压接 / Screw Crimping           |        |        |        |
| 锁紧方式 / Connect locking system    | 螺纹锁紧 / Screw Lock               |        |        |        |
| 防护等级 / Degree of protection      | IP67                            |        |        |        |
| 插拔次数 / Mechanical durability     | 500 次                           |        |        |        |
| 工作温度 / Operation temperature     | -25 °C ~ +85 °C                 |        |        |        |
| 接触电阻 / Contact resistance        | ≤ 10mΩ                          |        |        |        |
| 绝缘电阻 / Insulation resistance     | ≥ 1000MΩ                        |        |        |        |
| 胶芯材料 / Housing material          | 尼龙PA66                          |        |        |        |
| 端子材料 / Pin material              | 黄铜镀金 / Brass With Gold Plated   |        |        |        |
| 螺母和铜壳材料 / Nut and shell material | 黄铜镀镍 / Brass With Nickel Plated |        |        |        |
| 胶圈材料 / Gasket material           | 橡胶圈 / Rubber Ring               |        |        |        |

## M8母直头塑胶组装式插头 螺钉压接

产品图 / Product photo



尺寸图 / Dimension

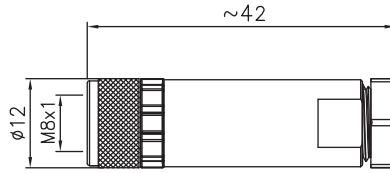

针位分布前视图 / Pin assignment front view

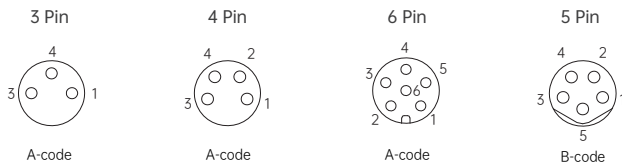

订货信息 / Order daea

| 芯数 / Number of cores | Coding | 料号 / Part number | Qty      |
|----------------------|--------|------------------|----------|
| 03 Pin               | A-code | M08A03-02-010    | 1000 pcs |
| 04 Pin               | A-code | M08A04-02-010    | 1000 pcs |
| 05 Pin               | B-code | M08B05-02-010    | 1000 pcs |
| 06 Pin               | A-code | M08A06-02-010    | 1000 pcs |

技术参数 / Specifications

| 芯数 / Pin                         | 03 Pin                          | 04 Pin | 05 Pin | 06 Pin |
|----------------------------------|---------------------------------|--------|--------|--------|
| 额定电流 / Rated current             | 3 A                             | 3 A    | 3 A    | 1 A    |
| 额定电压 / Rated voltage             | 60 V                            | 30 V   | 30 V   | 30 V   |
| 标准 / Standard                    | IEC 61076-2-104                 |        |        |        |
| 接线方式 / Termination               | 螺钉压接 / Screw Crimping           |        |        |        |
| 锁紧方式 / Connect locking system    | 螺纹锁紧 / Screw Lock               |        |        |        |
| 防护等级 / Degree of protection      | IP67                            |        |        |        |
| 插拔次数 / Mechanical durability     | 500 次                           |        |        |        |
| 工作温度 / Operation temperature     | -25 °C ~ +85 °C                 |        |        |        |
| 接触电阻 / Contact resistance        | ≤ 10mΩ                          |        |        |        |
| 绝缘电阻 / Insulation resistance     | ≥ 1000MΩ                        |        |        |        |
| 胶芯材料 / Housing material          | 尼龙PA66                          |        |        |        |
| 端子材料 / Pin material              | 黄铜镀金 / Brass With Gold Plated   |        |        |        |
| 螺母和铜壳材料 / Nut and shell material | 黄铜镀镍 / Brass With Nickel Plated |        |        |        |
| 胶圈材料 / Gasket material           | 橡胶圈 / Rubber Ring               |        |        |        |

## M8公弯头塑胶组装式插头 螺钉压接

产品图 / Product photo



尺寸图 / Dimension

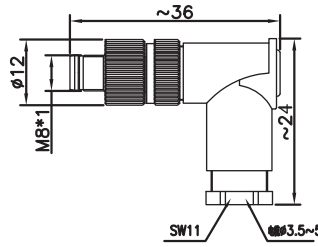

针位分布前视图 / Pin assignment front view

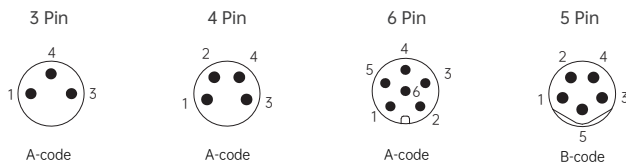

订货信息 / Order daec

| 芯数 / Number of cores | Coding | 料号 / Part number | Qty      |
|----------------------|--------|------------------|----------|
| 03 Pin               | A-code | M08A03-01-011    | 1000 pcs |
| 04 Pin               | A-code | M08A04-01-011    | 1000 pcs |
| 05 Pin               | B-code | M08B05-01-011    | 1000 pcs |
| 06 Pin               | A-code | M08A06-01-011    | 1000 pcs |

技术参数 / Specifications

| 芯数 / Pin                         | 03 Pin                          | 04 Pin | 05 Pin | 06 Pin |
|----------------------------------|---------------------------------|--------|--------|--------|
| 额定电流 / Rated current             | 3 A                             | 3 A    | 3 A    | 1 A    |
| 额定电压 / Rated voltage             | 60 V                            | 30 V   | 30 V   | 30 V   |
| 标准 / Standard                    | IEC 61076-2-104                 |        |        |        |
| 接线方式 / Termination               | 螺钉压接 / Screw Crimping           |        |        |        |
| 锁紧方式 / Connect locking system    | 螺纹锁紧 / Screw Lock               |        |        |        |
| 防护等级 / Degree of protection      | IP67                            |        |        |        |
| 插拔次数 / Mechanical durability     | 500 次                           |        |        |        |
| 工作温度 / Operation temperature     | -25 °C ~ +85 °C                 |        |        |        |
| 接触电阻 / Contact resistance        | ≤ 10mΩ                          |        |        |        |
| 绝缘电阻 / Insulation resistance     | ≥ 1000MΩ                        |        |        |        |
| 胶芯材料 / Housing material          | 尼龙PA66                          |        |        |        |
| 端子材料 / Pin material              | 黄铜镀金 / Brass With Gold Plated   |        |        |        |
| 螺母和铜壳材料 / Nut and shell material | 黄铜镀镍 / Brass With Nickel Plated |        |        |        |
| 胶圈材料 / Gasket material           | 橡胶圈 / Rubber Ring               |        |        |        |

## M8母弯头塑胶组装式插头 螺钉压接

产品图 / Product photo



尺寸图 / Dimension

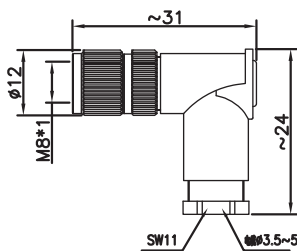

针位分布前视图 / Pin assignment front view

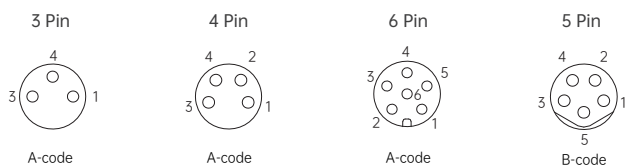

订货信息 / Order daec

| 芯数 / Number of cores | Coding | 料号 / Part number | Qty      |
|----------------------|--------|------------------|----------|
| 03 Pin               | A-code | M08A03-02-011    | 1000 pcs |
| 04 Pin               | A-code | M08A04-02-011    | 1000 pcs |
| 05 Pin               | B-code | M08B05-02-011    | 1000 pcs |
| 06 Pin               | A-code | M08A06-02-011    | 1000 pcs |

技术参数 / Specifications

| 芯数 / Pin                         | 03 Pin                          | 04 Pin | 05 Pin | 06 Pin |
|----------------------------------|---------------------------------|--------|--------|--------|
| 额定电流 / Rated current             | 3 A                             | 3 A    | 3 A    | 1 A    |
| 额定电压 / Rated voltage             | 60 V                            | 30 V   | 30 V   | 30 V   |
| 标准 / Standard                    | IEC 61076-2-104                 |        |        |        |
| 接线方式 / Termination               | 螺钉压接 / Screw Crimping           |        |        |        |
| 锁紧方式 / Connect locking system    | 螺纹锁紧 / Screw Lock               |        |        |        |
| 防护等级 / Degree of protection      | IP67                            |        |        |        |
| 插拔次数 / Mechanical durability     | 500 次                           |        |        |        |
| 工作温度 / Operation temperature     | -25 °C ~ +85 °C                 |        |        |        |
| 接触电阻 / Contact resistance        | ≤ 10mΩ                          |        |        |        |
| 绝缘电阻 / Insulation resistance     | ≥ 1000MΩ                        |        |        |        |
| 胶芯材料 / Housing material          | 尼龙PA66                          |        |        |        |
| 端子材料 / Pin material              | 黄铜镀金 / Brass With Gold Plated   |        |        |        |
| 螺母和铜壳材料 / Nut and shell material | 黄铜镀镍 / Brass With Nickel Plated |        |        |        |
| 胶圈材料 / Gasket material           | 橡胶圈 / Rubber Ring               |        |        |        |

## M8前锁面板式线端公头 焊线型M8 SW10-16L全金属

产品图 / Product photo



尺寸图 / Dimension

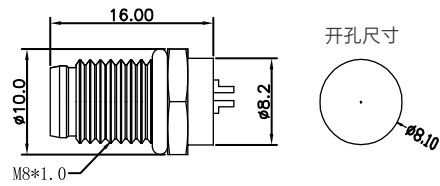

针位分布前视图 / Pin assignment front view

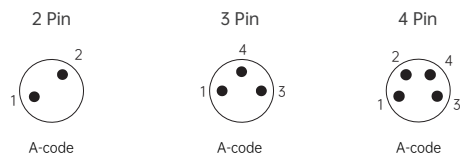

订货信息 / Order daec

| 芯数 / Number of cores | Coding | 料号 / Part number | Qty      |
|----------------------|--------|------------------|----------|
| 02 Pin               | A-code | M08A02-03-032    | 1000 pcs |
| 03 Pin               | A-code | M08A03-03-032    | 1000 pcs |
| 04 Pin               | A-code | M08A04-03-032    | 1000 pcs |

技术参数 / Specifications

| 芯数 / Pin                         | 02 Pin                          | 03 Pin | 04 Pin |
|----------------------------------|---------------------------------|--------|--------|
| 额定电流 / Rated current             | 4 A                             | 4 A    | 4 A    |
| 额定电压 / Rated voltage             | 60 V                            | 60 V   | 60 V   |
| 标准 / Standard                    | IEC 61076-2-104                 |        |        |
| 接线方式 / Termination               | 焊线 / Solder                     |        |        |
| 锁紧方式 / Connect locking system    | 螺纹锁紧 / Screw Lock               |        |        |
| 防护等级 / Degree of protection      | IP67 / IP68                     |        |        |
| 插拔次数 / Mechanical durability     | 500次                            |        |        |
| 工作温度 / Operation temperature     | -25 °C ~ +85 °C                 |        |        |
| 接触电阻 / Contact resistance        | ≤ 10mΩ                          |        |        |
| 绝缘电阻 / Insulation resistance     | ≥ 1000MΩ                        |        |        |
| 胶芯材料 / Housing material          | 尼龙PA66                          |        |        |
| 端子材料 / Pin material              | 黄铜镀金 / Brass With Gold Plated   |        |        |
| 螺母和铜壳材料 / Nut and shell material | 黄铜镀镍 / Brass With Nickel Plated |        |        |
| 胶圈材料 / Gasket material           | 氟胶圈 / Fluorine Ring             |        |        |
| 黑色胶水 / Black glue                | 环氧树脂 / Epoxy resin              |        |        |



## M8前锁面板式线端公头 焊线型M8 SW10-17.6L全金属

产品图 / Product photo



尺寸图 / Dimension

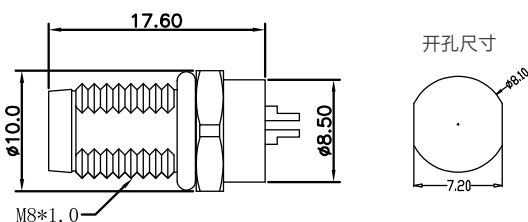

针位分布前视图 / Pin assignment front view

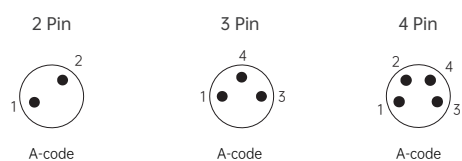

订货信息 / Order daec

| 芯数 / Number of cores | Coding | 料号 / Part number | Qty      |
|----------------------|--------|------------------|----------|
| 02 Pin               | A-code | M08A02-03-035    | 1000 pcs |
| 03 Pin               | A-code | M08A03-03-035    | 1000 pcs |
| 04 Pin               | A-code | M08A04-03-035    | 1000 pcs |

技术参数 / Specifications

| 芯数 / Pin                         | 02 Pin                          | 03 Pin | 04 Pin |
|----------------------------------|---------------------------------|--------|--------|
| 额定电流 / Rated Current             | 4 A                             | 4 A    | 4 A    |
| 额定电压 / Rated voltage             | 60 V                            | 60 V   | 60 V   |
| 标准 / Standard                    | IEC 61076-2-104                 |        |        |
| 接线方式 / Termination               | 焊线 / Solder                     |        |        |
| 锁紧方式 / Connect Locking System    | 螺纹锁紧 / Screw Lock               |        |        |
| 防护等级 / Degree of Protection      | IP67 / IP68                     |        |        |
| 插拔次数 / Mechanical durability     | 500次                            |        |        |
| 工作温度 / Operation Temperature     | -25 °C ~ +85 °C                 |        |        |
| 接触电阻 / Contact Resistance        | ≤ 10mΩ                          |        |        |
| 绝缘电阻 / Insulation Resistance     | ≥ 1000MΩ                        |        |        |
| 胶芯材料 / Housing material          | 尼龙PA66                          |        |        |
| 端子材料 / Pin Material              | 黄铜镀金 / Brass With Gold Plated   |        |        |
| 螺母和铜壳材料 / Nut and shell material | 黄铜镀镍 / Brass With Nickel Plated |        |        |
| 胶圈材料 / Gasket material           | 氟胶圈 / Fluorine Ring             |        |        |
| 黑色胶水 / Black glue                | 环氧树脂 / Epoxy resin              |        |        |

## M8前锁面板式线端公头 焊线型M8 SW10T-13.7L后灌胶

产品图 / Product photo



尺寸图 / Dimension

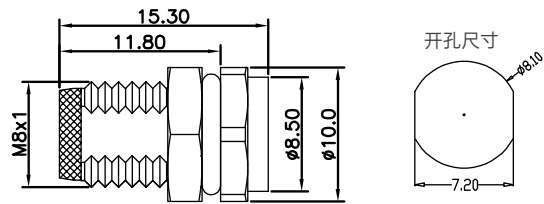

针位分布前视图 / Pin assignment front view

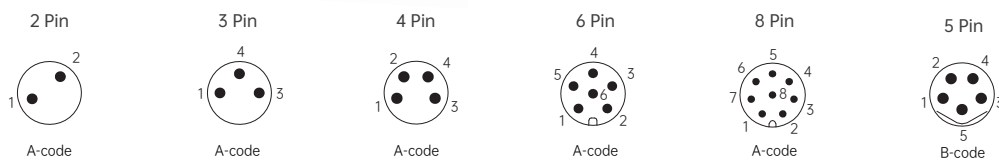

订货信息 / Order daea

| 芯数 / Number of cores | Coding | 料号 / Part number | Qty      |
|----------------------|--------|------------------|----------|
| 02 Pin               | A-code | M08A02-03-037    | 1000 pcs |
| 03 Pin               | A-code | M08A03-03-037    | 1000 pcs |
| 04 Pin               | A-code | M08A04-03-037    | 1000 pcs |
| 05 Pin               | B-code | M08B05-03-037    | 1000 pcs |
| 06 Pin               | A-code | M08A06-03-037    | 1000 pcs |
| 08 Pin               | A-code | M08A08-03-037    | 1000 pcs |

技术参数 / Specifications

| 芯数 / Pin                         | 02 Pin                          | 03 Pin | 04 Pin | 05 Pin | 06 Pin | 08 Pin |
|----------------------------------|---------------------------------|--------|--------|--------|--------|--------|
| 额定电流 / Rated current             | 4 A                             | 4 A    | 4 A    | 4 A    | 2 A    | 2 A    |
| 额定电压 / Rated voltage             | 60 V                            | 60 V   | 60 V   | 30 V   | 60 V   | 60 V   |
| 标准 / Standard                    | IEC 61076-2-104                 |        |        |        |        |        |
| 接线方式 / Termination               | 焊线 / Solder                     |        |        |        |        |        |
| 锁紧方式 / Connect locking system    | 螺纹锁紧 / Screw Lock               |        |        |        |        |        |
| 防护等级 / Degree of protection      | IP67 / IP68                     |        |        |        |        |        |
| 插拔次数 / Mechanical durability     | 500次                            |        |        |        |        |        |
| 工作温度 / Operation temperature     | -25 °C ~ +85 °C                 |        |        |        |        |        |
| 接触电阻 / Contact resistance        | ≤ 10mΩ                          |        |        |        |        |        |
| 绝缘电阻 / Insulation resistance     | ≥ 1000MΩ                        |        |        |        |        |        |
| 胶芯材料 / Housing material          | 尼龙PA66                          |        |        |        |        |        |
| 端子材料 / Pin material              | 黄铜镀金 / Brass With Gold Plated   |        |        |        |        |        |
| 螺母和铜壳材料 / Nut and shell material | 黄铜镀镍 / Brass With Nickel Plated |        |        |        |        |        |
| 胶圈材料 / Gasket material           | 氟胶圈 / Fluorine Ring             |        |        |        |        |        |
| 黑色胶水 / Black glue                | 环氧树脂 / Epoxy resin              |        |        |        |        |        |

## M8面板式线端公头 焊线型一体式带牙五金外壳15.5L

产品图 / Product photo



尺寸图 / Dimension

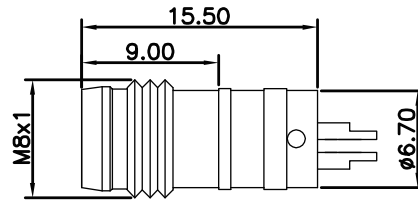

针位分布前视图 / Pin assignment front view

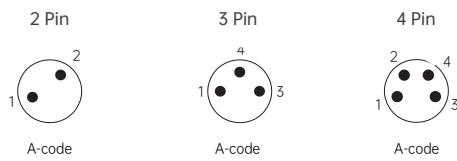

订货信息 / Order daec

| 芯数 / Number of cores | Coding | 料号 / Part number | Qty      |
|----------------------|--------|------------------|----------|
| 02 Pin               | A-code | M08A02-03-036    | 1000 pcs |
| 03 Pin               | A-code | M08A03-03-036    | 1000 pcs |
| 04 Pin               | A-code | M08A04-03-036    | 1000 pcs |

技术参数 / Specifications

| 芯数 / Pin   | 02 Pin                                    | 03 Pin                                    | 04 Pin                                    |
|--|---|---|---|
| 额定电流 / Rated current                                 | 4 A                                       | 4 A                                       | 4 A                                       |
| 额定电压 / Rated voltage                                 | 60 V                                      | 60 V                                      | 60 V                                      |
| 线规 (mm <sup>2</sup> ) / Wire gauge(mm <sup>2</sup> ) | 0.14mm <sup>2</sup> ~ 0.34mm <sup>2</sup> | 0.14mm <sup>2</sup> ~ 0.34mm <sup>2</sup> | 0.14mm <sup>2</sup> ~ 0.34mm <sup>2</sup> |
| 线号 (AWG) / Wire gauge(AWG)                           | 26AWG ~ 22AWG                             | 26AWG ~ 22AWG                             | 26AWG ~ 22AWG                             |
| 标准 / Standard  | IEC 61076-2-104                           |   |   |
| 接线方式 / Termination                                   | 焊线 / Solder                               |   |   |
| 锁紧方式 / Connect locking system                        | 螺纹锁紧 / Screw Lock                         |   |   |
| 防护等级 / Degree of protection                          | IP67 / IP68                               |   |   |
| 插拔次数 / Mechanical durability                         | 500次                                      |   |   |
| 工作温度 / Operation temperature                         | -25 °C ~ +85 °C                           |   |   |
| 接触电阻 / Contact resistance                            | ≤ 10mΩ                                    |   |   |
| 绝缘电阻 / Insulation resistance                         | ≥ 1000MΩ                                  |   |   |
| 胶芯材料 / Housing material                              | 尼龙PA66                                    |   |   |
| 端子材料 / Pin material                                  | 黄铜镀金 / Brass With Gold Plated             |   |   |
| 屏蔽管材料 / Spring                                       | 黄铜镀镍 / Brass With Nickel Plated           |   |   |

## M8面板式线端公头 焊板型一体式带牙五金外壳14L 全屏蔽

产品图 / Product photo



尺寸图 / Dimension

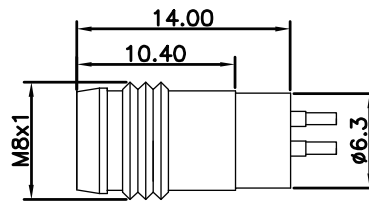

针位分布前视图 / Pin assignment front view

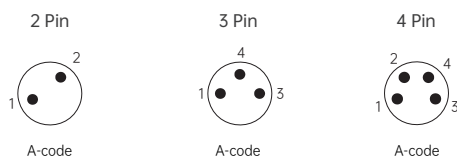

订货信息 / Order daec

| 芯数 / Number of cores | Coding | 料号 / Part number | Qty      |
|----------------------|--------|------------------|----------|
| 02 Pin               | A-code | M08A02-03-035    | 1000 pcs |
| 03 Pin               | A-code | M08A03-03-035    | 1000 pcs |
| 04 Pin               | A-code | M08A04-03-035    | 1000 pcs |

技术参数 / Specifications

| 芯数 / Pin   | 02 Pin                                    | 03 Pin                                    | 04 Pin                                    |
|--|---|---|---|
| 额定电流 / Rated current                                 | 4 A                                       | 4 A                                       | 4 A                                       |
| 额定电压 / Rated voltage                                 | 60 V                                      | 60 V                                      | 60 V                                      |
| 线规 (mm <sup>2</sup> ) / Wire gauge(mm <sup>2</sup> ) | 0.14mm <sup>2</sup> ~ 0.34mm <sup>2</sup> | 0.14mm <sup>2</sup> ~ 0.34mm <sup>2</sup> | 0.14mm <sup>2</sup> ~ 0.34mm <sup>2</sup> |
| 线号 (AWG) / Wire gauge(AWG)                           | 26AWG ~ 22AWG                             | 26AWG ~ 22AWG                             | 26AWG ~ 22AWG                             |
| 标准 / Standard  | IEC 61076-2-104                           |   |   |
| 接线方式 / Termination                                   | 浸焊 / Dip-Solder                           |   |   |
| 锁紧方式 / Connect locking system                        | 螺纹锁紧 / Screw Lock                         |   |   |
| 防护等级 / Degree of protection                          | IP67 / IP68                               |   |   |
| 插拔次数 / Mechanical durability                         | 500次                                      |   |   |
| 工作温度 / Operation temperature                         | -25 °C ~ +85 °C                           |   |   |
| 接触电阻 / Contact resistance                            | ≤ 10mΩ                                    |   |   |
| 绝缘电阻 / Insulation resistance                         | ≥ 1000MΩ                                  |   |   |
| 胶芯材料 / Housing material                              | 尼龙PA66                                    |   |   |
| 端子材料 / Pin material                                  | 黄铜镀金 / Brass With Gold Plated             |   |   |
| 屏蔽管材料 / Spring                                       | 黄铜镀镍 / Brass With Nickel Plated           |   |   |

## M8前锁面板式线端母头 焊线型M10 SW12T-15.5L

产品图 / Product photo



尺寸图 / Dimension

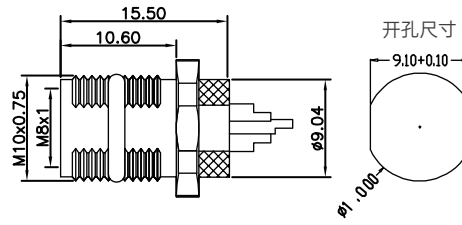

针位分布前视图 / Pin assignment front view

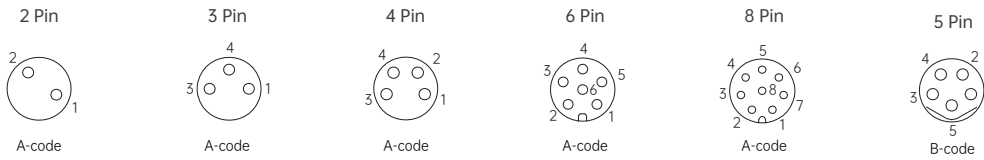

订货信息 / Order daec

| 芯数 / Number of cores | Coding | 料号 / Part number | Qty      |
|----------------------|--------|------------------|----------|
| 02 Pin               | A-code | M08A02-04-027    | 1000 pcs |
| 03 Pin               | A-code | M08A03-04-027    | 1000 pcs |
| 04 Pin               | A-code | M08A04-04-027    | 1000 pcs |
| 05 Pin               | B-code | M08B05-04-027    | 1000 pcs |
| 06 Pin               | A-code | M08A06-04-027    | 1000 pcs |
| 08 Pin               | A-code | M08A08-04-027    | 1000 pcs |

技术参数 / Specifications

| 芯数 / Pin                         | 02 Pin                          | 03 Pin | 04 Pin | 05 Pin | 06 Pin | 08 Pin |
|----------------------------------|---------------------------------|--------|--------|--------|--------|--------|
| 额定电流 / Rated current             | 4 A                             | 4 A    | 4 A    | 4 A    | 2 A    | 2 A    |
| 额定电压 / Rated voltage             | 60 V                            | 60 V   | 60 V   | 30 V   | 60 V   | 60 V   |
| 标准 / Standard                    | IEC 61076-2-104                 |        |        |        |        |        |
| 接线方式 / Termination               | 焊线 / Solder                     |        |        |        |        |        |
| 锁紧方式 / Connect locking system    | 螺纹锁紧 / Screw Lock               |        |        |        |        |        |
| 防护等级 / Degree of protection      | IP67 / IP68                     |        |        |        |        |        |
| 插拔次数 / Mechanical durability     | 500次                            |        |        |        |        |        |
| 工作温度 / Operation temperature     | -25 °C ~ +85 °C                 |        |        |        |        |        |
| 接触电阻 / Contact resistance        | ≤ 10mΩ                          |        |        |        |        |        |
| 绝缘电阻 / Insulation resistance     | ≥ 1000MΩ                        |        |        |        |        |        |
| 胶芯材料 / Housing material          | 尼龙PA66                          |        |        |        |        |        |
| 端子材料 / Pin material              | 黄铜镀金 / Brass With Gold Plated   |        |        |        |        |        |
| 螺母和铜壳材料 / Nut and shell material | 黄铜镀镍 / Brass With Nickel Plated |        |        |        |        |        |
| 胶圈材料 / Gasket material           | 氟胶圈 / Fluorine ring             |        |        |        |        |        |
| 黑色胶水 / Black glue                | 环氧树脂 / Epoxy resin              |        |        |        |        |        |

## M8前锁面板式线端母头 焊线型M10 SW14T-16L

产品图 / Product photo



尺寸图 / Dimension

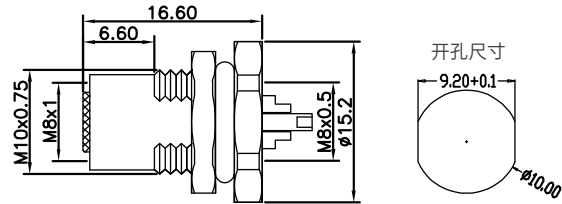

针位分布前视图 / Pin assignment front view

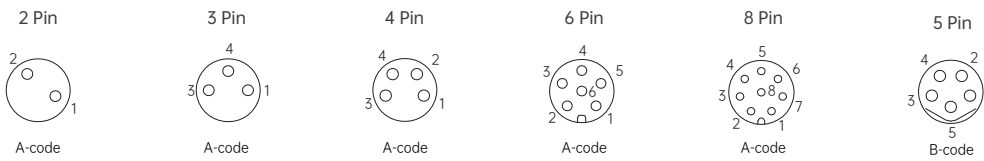

订货信息 / Order daec

| 芯数 / Number of cores | Coding | 料号 / Part number | Qty      |
|----------------------|--------|------------------|----------|
| 02 Pin               | A-code | M08A02-04-029    | 1000 pcs |
| 03 Pin               | A-code | M08A03-04-029    | 1000 pcs |
| 04 Pin               | A-code | M08A04-04-029    | 1000 pcs |
| 05 Pin               | B-code | M08B05-04-029    | 1000 pcs |
| 06 Pin               | A-code | M08A06-04-029    | 1000 pcs |
| 08 Pin               | A-code | M08A08-04-029    | 1000 pcs |

技术参数 / Specifications

| 芯数 / Pin                         | 02 Pin                          | 03 Pin | 04 Pin | 05 Pin | 06 Pin | 08 Pin |
|----------------------------------|---------------------------------|--------|--------|--------|--------|--------|
| 额定电流 / Rated current             | 4 A                             | 4 A    | 4 A    | 4 A    | 2 A    | 2 A    |
| 额定电压 / Rated voltage             | 60 V                            | 60 V   | 60 V   | 30 V   | 60 V   | 60 V   |
| 标准 / Standard                    | IEC 61076-2-104                 |        |        |        |        |        |
| 接线方式 / Termination               | 焊线 / Solder                     |        |        |        |        |        |
| 锁紧方式 / Connect locking system    | 螺纹锁紧 / Screw Lock               |        |        |        |        |        |
| 防护等级 / Degree of protection      | IP67 / IP68                     |        |        |        |        |        |
| 插拔次数 / Mechanical durability     | 500次                            |        |        |        |        |        |
| 工作温度 / Operation temperature     | -25 °C ~ +85 °C                 |        |        |        |        |        |
| 接触电阻 / Contact resistance        | ≤ 10mΩ                          |        |        |        |        |        |
| 绝缘电阻 / Insulation resistance     | ≥ 1000MΩ                        |        |        |        |        |        |
| 胶芯材料 / Housing material          | 尼龙PA66                          |        |        |        |        |        |
| 端子材料 / Pin material              | 黄铜镀金 / Brass With Gold Plated   |        |        |        |        |        |
| 螺母和铜壳材料 / Nut and shell material | 黄铜镀镍 / Brass With Nickel Plated |        |        |        |        |        |
| 胶圈材料 / Gasket material           | 氟胶圈 / Fluorine Ring             |        |        |        |        |        |
| 黑色胶水 / Black glue                | 环氧树脂 / Epoxy resin              |        |        |        |        |        |

## M8前锁面板式板端公头 焊板型M8 SW10T-13.7L先灌胶

产品图 / Product photo



尺寸图 / Dimension

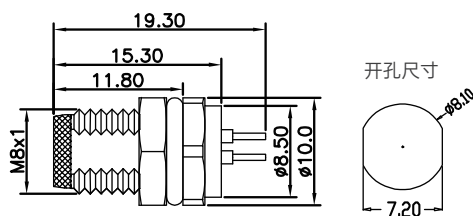

针位分布前视图 / Pin assignment front view

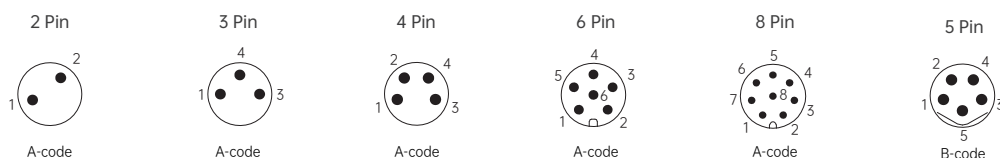

订货信息 / Order daec

| 芯数 / Number of cores | Coding | 料号 / Part number | Qty      |
|----------------------|--------|------------------|----------|
| 02 Pin               | A-code | M08A02-03-043    | 1000 pcs |
| 03 Pin               | A-code | M08A03-03-043    | 1000 pcs |
| 04 Pin               | A-code | M08A04-03-043    | 1000 pcs |
| 05 Pin               | B-code | M08B05-03-043    | 1000 pcs |
| 06 Pin               | A-code | M08A06-03-043    | 1000 pcs |
| 08 Pin               | A-code | M08A08-03-043    | 1000 pcs |

技术参数 / Specifications

| 芯数 / Pin                         | 02 Pin                          | 03 Pin | 04 Pin | 05 Pin | 06 Pin | 08 Pin |
|----------------------------------|---------------------------------|--------|--------|--------|--------|--------|
| 额定电流 / Rated current             | 4 A                             | 4 A    | 4 A    | 4 A    | 2 A    | 2 A    |
| 额定电压 / Rated voltage             | 60 V                            | 60 V   | 60 V   | 30 V   | 60 V   | 60 V   |
| 标准 / Standard                    | IEC 61076-2-104                 |        |        |        |        |        |
| 接线方式 / Termination               | 浸焊 / Dip-Solder                 |        |        |        |        |        |
| 锁紧方式 / Connect locking system    | 螺纹锁紧 / Screw Lock               |        |        |        |        |        |
| 防护等级 / Degree of protection      | IP67 / IP68                     |        |        |        |        |        |
| 插拔次数 / Mechanical durability     | 500次                            |        |        |        |        |        |
| 工作温度 / Operation temperature     | -25 °C ~ +85 °C                 |        |        |        |        |        |
| 接触电阻 / Contact resistance        | ≤ 10mΩ                          |        |        |        |        |        |
| 绝缘电阻 / Insulation resistance     | ≥ 1000MΩ                        |        |        |        |        |        |
| 胶芯材料 / Housing material          | 尼龙PA66                          |        |        |        |        |        |
| 端子材料 / Pin material              | 黄铜镀金 / Brass With Gold Plated   |        |        |        |        |        |
| 螺母和铜壳材料 / Nut and shell material | 黄铜镀镍 / Brass With Nickel Plated |        |        |        |        |        |
| 胶圈材料 / Gasket material           | 氟胶圈 / Fluorine Ring             |        |        |        |        |        |
| 黑色胶水 / Black glue                | 环氧树脂 / Epoxy resin              |        |        |        |        |        |

## M8前锁面板式板端公头 焊板型M8 SW10-16L全金属

产品图 / Product photo



尺寸图 / Dimension

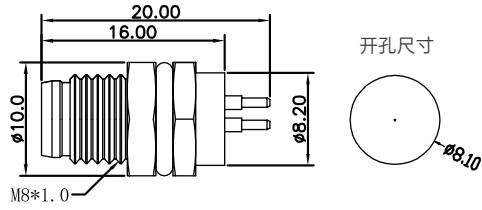

针位分布前视图 / Pin assignment front view

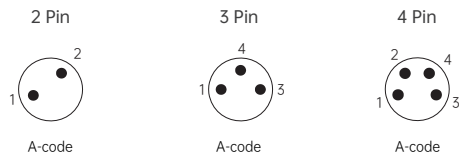

订货信息 / Order daec

| 芯数 / Number of cores | Coding | 料号 / Part number | Qty      |
|----------------------|--------|------------------|----------|
| 02 Pin               | A-code | M08A02-03-030    | 1000 pcs |
| 03 Pin               | A-code | M08A03-03-030    | 1000 pcs |
| 04 Pin               | A-code | M08A04-03-030    | 1000 pcs |

技术参数 / Specifications

| 芯数 / Pin                         | 02 Pin                          | 03 Pin | 04 Pin |
|----------------------------------|---------------------------------|--------|--------|
| 额定电流 / Rated current             | 4 A                             | 4 A    | 4 A    |
| 额定电压 / Rated voltage             | 60 V                            | 60 V   | 60 V   |
| 标准 / Standard                    | IEC 61076-2-104                 |        |        |
| 接线方式 / Termination               | 浸焊 / Dip-Solder                 |        |        |
| 锁紧方式 / Connect locking system    | 螺纹锁紧 / Screw Lock               |        |        |
| 防护等级 / Degree of protection      | IP67 / IP68                     |        |        |
| 插拔次数 / Mechanical durability     | 500次                            |        |        |
| 工作温度 / Operation temperature     | -25 °C ~ +85 °C                 |        |        |
| 接触电阻 / Contact resistance        | ≤ 10mΩ                          |        |        |
| 绝缘电阻 / Insulation resistance     | ≥ 1000MΩ                        |        |        |
| 胶芯材料 / Housing material          | 尼龙PA66                          |        |        |
| 端子材料 / Pin material              | 黄铜镀金 / Brass With Gold Plated   |        |        |
| 螺母和铜壳材料 / Nut and shell material | 黄铜镀镍 / Brass With Nickel Plated |        |        |
| 胶圈材料 / Gasket material           | 氟胶圈 / Fluorine Ring             |        |        |
| 黑色胶水 / Black glue                | 环氧树脂 / Epoxy resin              |        |        |



## M8前锁面板式板端公头 焊板型M8 SW10-17.6L全金属

产品图 / Product photo



尺寸图 / Dimension

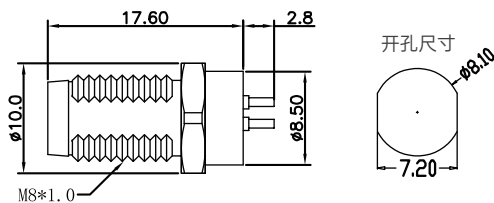

针位分布前视图 / Pin assignment front view

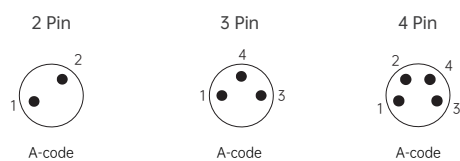

订货信息 / Order daec

| 芯数 / Number of cores | Coding | 料号 / Part number | Qty      |
|----------------------|--------|------------------|----------|
| 02 Pin               | A-code | M08A02-03-031    | 1000 pcs |
| 03 Pin               | A-code | M08A03-03-031    | 1000 pcs |
| 04 Pin               | A-code | M08A04-03-031    | 1000 pcs |

技术参数 / Specifications

| 芯数 / Pin                         | 02 Pin                          | 03 Pin | 04 Pin |
|----------------------------------|---------------------------------|--------|--------|
| 额定电流 / Rated current             | 4 A                             | 4 A    | 4 A    |
| 额定电压 / Rated voltage             | 60 V                            | 60 V   | 60 V   |
| 标准 / Standard                    | IEC 61076-2-104                 |        |        |
| 接线方式 / Termination               | 浸焊 / Dip-Solder                 |        |        |
| 锁紧方式 / Connect locking system    | 螺纹锁紧 / Screw Lock               |        |        |
| 防护等级 / Degree of protection      | IP67 / IP68                     |        |        |
| 插拔次数 / Mechanical durability     | 500次                            |        |        |
| 工作温度 / Operation temperature     | -25 °C ~ +85 °C                 |        |        |
| 接触电阻 / Contact resistance        | ≤ 10mΩ                          |        |        |
| 绝缘电阻 / Insulation resistance     | ≥ 1000MΩ                        |        |        |
| 胶芯材料 / Housing material          | 尼龙PA66                          |        |        |
| 端子材料 / Pin material              | 黄铜镀金 / Brass With Gold Plated   |        |        |
| 螺母和铜壳材料 / Nut and shell material | 黄铜镀镍 / Brass With Nickel Plated |        |        |
| 胶圈材料 / Gasket material           | 氟胶圈 / Fluorine Ring             |        |        |
| 黑色胶水 / Black glue                | 环氧树脂 / Epoxy resin              |        |        |

## M8前锁面板式板端公弯头 焊板型屏蔽款螺牙M8x1 接地

产品图 / Product photo



尺寸图 / Dimension

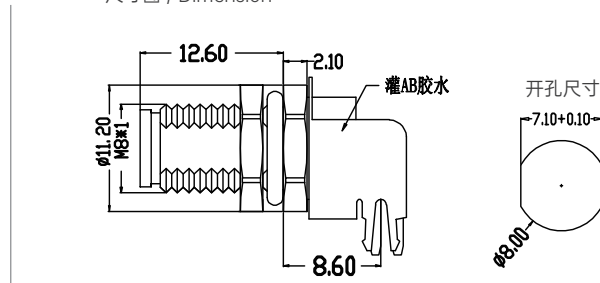

针位分布前视图 / Pin assignment front view

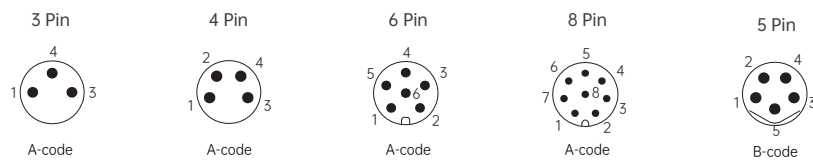

订货信息 / Order daec

| 芯数 / Number of cores | Coding | 料号 / Part number | Qty      |
|----------------------|--------|------------------|----------|
| 03 Pin               | A-code | M08A03-03-042    | 1000 pcs |
| 04 Pin               | A-code | M08A04-03-042    | 1000 pcs |
| 05 Pin               | B-code | M08B05-03-042    | 1000 pcs |
| 06 Pin               | A-code | M08A06-03-042    | 1000 pcs |
| 08 Pin               | A-code | M08A08-03-042    | 1000 pcs |

技术参数 / Specifications

| 芯数 / Pin                         | 03 Pin                          | 04 Pin | 05 Pin | 06 Pin | 08 Pin |
|----------------------------------|---------------------------------|--------|--------|--------|--------|
| 额定电流 / Rated current             | 4 A                             | 4 A    | 4 A    | 2 A    | 2 A    |
| 额定电压 / Rated voltage             | 60 V                            | 60 V   | 30 V   | 30 V   | 30 V   |
| 标准 / Standard                    | IEC 61076-2-104                 |        |        |        |        |
| 接线方式 / Termination               | 浸焊 / Dip-Solder                 |        |        |        |        |
| 锁紧方式 / Connect locking system    | 螺纹锁紧 / Screw Lock               |        |        |        |        |
| 防护等级 / Degree of protection      | IP67 / IP68                     |        |        |        |        |
| 插拔次数 / Mechanical durability     | 500次                            |        |        |        |        |
| 工作温度 / Operation temperature     | -25 °C ~ +85 °C                 |        |        |        |        |
| 接触电阻 / Contact resistance        | ≤ 20mΩ                          |        |        |        |        |
| 绝缘电阻 / Insulation resistance     | ≥ 1000MΩ                        |        |        |        |        |
| 胶芯材料 / Housing material          | 尼龙PA66                          |        |        |        |        |
| 端子材料 / Pin material              | 黄铜镀金 / Brass With Gold Plated   |        |        |        |        |
| 螺母和铜壳材料 / Nut and shell material | 黄铜镀镍 / Brass With Nickel Plated |        |        |        |        |
| 胶圈材料 / Gasket material           | 氟胶圈 / Fluorine Ring             |        |        |        |        |
| 黑色胶水 / Black glue                | 环氧树脂 / Epoxy resin              |        |        |        |        |

## M8前锁面板式母座 板端母弯头 焊板型 非屏蔽

产品图 / Product photo



尺寸图 / Dimension

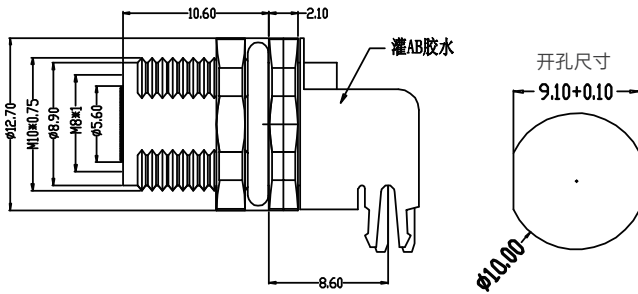

针位分布前视图 / Pin assignment front view

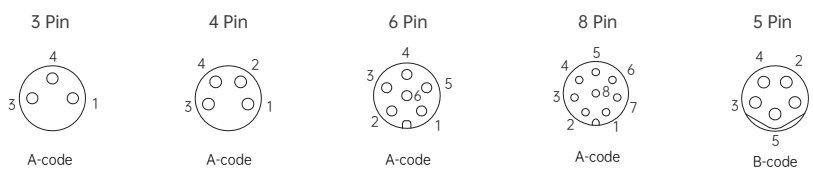

订货信息 / Order daec

| 芯数 / Number of cores | Coding | 料号 / Part number | Qty      |
|----------------------|--------|------------------|----------|
| 03 Pin               | A-code | M08A03-04-030    | 1000 pcs |
| 04 Pin               | A-code | M08A04-04-030    | 1000 pcs |
| 05 Pin               | B-code | M08B05-04-030    | 1000 pcs |
| 06 Pin               | A-code | M08A06-04-030    | 1000 pcs |
| 08 Pin               | A-code | M08A08-04-030    | 1000 pcs |

技术参数 / Specifications

| 芯数 / Pin                         | 03 Pin                          | 04 Pin | 05 Pin | 06 Pin | 08 Pin |
|----------------------------------|---------------------------------|--------|--------|--------|--------|
| 额定电流 / Rated current             | 4 A                             | 4 A    | 4 A    | 2 A    | 2 A    |
| 额定电压 / Rated voltage             | 60 V                            | 60 V   | 30 V   | 60 V   | 60 V   |
| 标准 / Standard                    | IEC 61076-2-104                 |        |        |        |        |
| 接线方式 / Termination               | 浸焊 / Dip-Solder                 |        |        |        |        |
| 锁紧方式 / Connect locking system    | 螺纹锁紧 / Screw Lock               |        |        |        |        |
| 防护等级 / Degree of protection      | IP67 / IP68                     |        |        |        |        |
| 插拔次数 / Mechanical durability     | 500次                            |        |        |        |        |
| 工作温度 / Operation temperature     | -25 °C ~ +85 °C                 |        |        |        |        |
| 接触电阻 / Contact resistance        | ≤ 20mΩ                          |        |        |        |        |
| 绝缘电阻 / Insulation resistance     | ≥ 1000MΩ                        |        |        |        |        |
| 胶芯材料 / Housing material          | 尼龙PA66                          |        |        |        |        |
| 端子材料 / Pin material              | 黄铜镀金 / Brass With Gold Plated   |        |        |        |        |
| 螺母和铜壳材料 / Nut and shell material | 黄铜镀镍 / Brass With Nickel Plated |        |        |        |        |
| 胶圈材料 / Gasket material           | 氟胶圈 / Fluorine Ring             |        |        |        |        |
| 黑色胶水 / Black glue                | 环氧树脂 / Epoxy resin              |        |        |        |        |

## M8后锁面板式线端公头 焊线型M8 SW10T-13.7L后灌胶

产品图 / Product photo



尺寸图 / Dimension

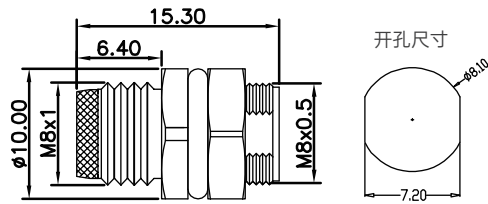

针位分布前视图 / Pin assignment front view

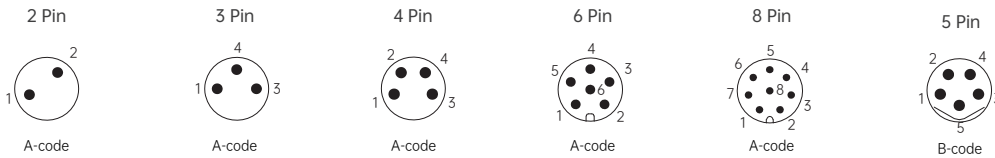

订货信息 / Order daec

| 芯数 / Number of cores | Coding | 料号 / Part number | Qty      |
|----------------------|--------|------------------|----------|
| 02 Pin               | A-code | M08A02-03-038    | 1000 pcs |
| 03 Pin               | A-code | M08A03-03-038    | 1000 pcs |
| 04 Pin               | A-code | M08A04-03-038    | 1000 pcs |
| 05 Pin               | B-code | M08B05-03-038    | 1000 pcs |
| 06 Pin               | A-code | M08A06-03-038    | 1000 pcs |
| 08 Pin               | A-code | M08A08-03-038    | 1000 pcs |

技术参数 / Specifications

| 芯数 / Pin                         | 02 Pin                          | 03 Pin | 04 Pin | 05 Pin | 06 Pin | 08 Pin |
|----------------------------------|---------------------------------|--------|--------|--------|--------|--------|
| 额定电流 / Rated current             | 4 A                             | 4 A    | 4 A    | 4 A    | 2 A    | 2 A    |
| 额定电压 / Rated voltage             | 60 V                            | 60 V   | 60 V   | 30 V   | 60 V   | 60 V   |
| 标准 / Standard                    | IEC 61076-2-104                 |        |        |        |        |        |
| 接线方式 / Termination               | 焊线 / Solder                     |        |        |        |        |        |
| 锁紧方式 / Connect locking system    | 螺纹锁紧 / Screw Lock               |        |        |        |        |        |
| 防护等级 / Degree of protection      | IP67 / IP68                     |        |        |        |        |        |
| 插拔次数 / Mechanical durability     | 500次                            |        |        |        |        |        |
| 工作温度 / Operation temperature     | -25 °C ~ +85 °C                 |        |        |        |        |        |
| 接触电阻 / Contact resistance        | ≤ 10mΩ                          |        |        |        |        |        |
| 绝缘电阻 / Insulation resistance     | ≥ 1000MΩ                        |        |        |        |        |        |
| 胶芯材料 / Housing material          | 尼龙PA66                          |        |        |        |        |        |
| 端子材料 / Pin material              | 黄铜镀金 / Brass With Gold Plated   |        |        |        |        |        |
| 螺母和铜壳材料 / Nut and shell material | 黄铜镀镍 / Brass With Nickel Plated |        |        |        |        |        |
| 胶圈材料 / Gasket material           | 氟胶圈 / Fluorine Ring             |        |        |        |        |        |
| 黑色胶水 / Black glue                | 环氧树脂 / Epoxy resin              |        |        |        |        |        |

## M8后锁面板式线端母头 焊线型M8 SW10T-13L

产品图 / Product photo



尺寸图 / Dimension

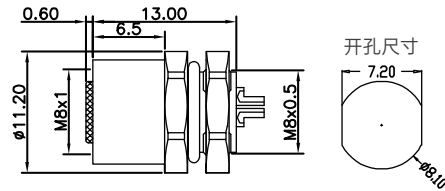

针位分布前视图 / Pin assignment front view

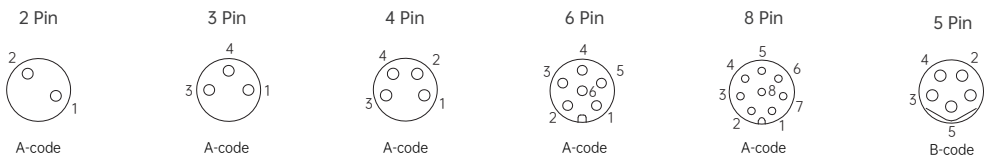

订货信息 / Order daea

| 芯数 / Number of cores | Coding | 料号 / Part number | Qty      |
|----------------------|--------|------------------|----------|
| 02 Pin               | A-code | M08A02-04-025    | 1000 pcs |
| 03 Pin               | A-code | M08A03-04-025    | 1000 pcs |
| 04 Pin               | A-code | M08A04-04-025    | 1000 pcs |
| 05 Pin               | B-code | M08B05-04-025    | 1000 pcs |
| 06 Pin               | A-code | M08A06-04-025    | 1000 pcs |
| 08 Pin               | A-code | M08A08-04-025    | 1000 pcs |

技术参数 / Specifications

| 芯数 / Pin                         | 02 Pin                          | 03 Pin | 04 Pin | 05 Pin | 06 Pin | 08 Pin |
|----------------------------------|---------------------------------|--------|--------|--------|--------|--------|
| 额定电流 / Rated current             | 4 A                             | 4 A    | 4 A    | 4 A    | 2 A    | 2 A    |
| 额定电压 / Rated voltage             | 60 V                            | 60 V   | 60 V   | 30 V   | 60 V   | 60 V   |
| 标准 / Standard                    | IEC 61076-2-104                 |        |        |        |        |        |
| 接线方式 / Termination               | 焊线 / Solder                     |        |        |        |        |        |
| 锁紧方式 / Connect locking system    | 螺纹锁紧 / Screw Lock               |        |        |        |        |        |
| 防护等级 / Degree of protection      | IP67 / IP68                     |        |        |        |        |        |
| 插拔次数 / Mechanical durability     | 500次                            |        |        |        |        |        |
| 工作温度 / Operation temperature     | -25 °C ~ +85 °C                 |        |        |        |        |        |
| 接触电阻 / Contact resistance        | ≤ 10mΩ                          |        |        |        |        |        |
| 绝缘电阻 / Insulation resistance     | ≥ 1000MΩ                        |        |        |        |        |        |
| 胶芯材料 / Housing material          | 尼龙PA66                          |        |        |        |        |        |
| 端子材料 / Pin material              | 黄铜镀金 / Brass With Gold Plated   |        |        |        |        |        |
| 螺母和铜壳材料 / Nut and shell material | 黄铜镀镍 / Brass With Nickel Plated |        |        |        |        |        |
| 胶圈材料 / Gasket material           | 氟胶圈 / Fluorine Ring             |        |        |        |        |        |
| 黑色胶水 / Black glue                | 环氧树脂 / Epoxy resin              |        |        |        |        |        |

## M8后锁面板式线端母头 焊线型M8 SW10T-16L

产品图 / Product photo



尺寸图 / Dimension

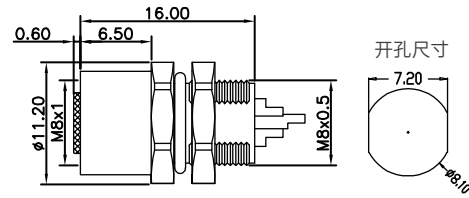

针位分布前视图 / Pin assignment front view

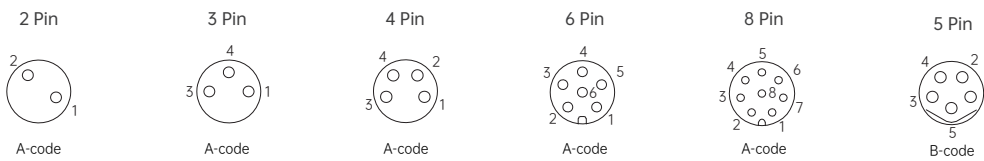

订货信息 / Order daec

| 芯数 / Number of cores | Coding | 料号 / Part number | Qty      |
|----------------------|--------|------------------|----------|
| 02 Pin               | A-code | M08A02-04-026    | 1000 pcs |
| 03 Pin               | A-code | M08A03-04-026    | 1000 pcs |
| 04 Pin               | A-code | M08A04-04-026    | 1000 pcs |
| 05 Pin               | B-code | M08B05-04-026    | 1000 pcs |
| 06 Pin               | A-code | M08A06-04-026    | 1000 pcs |
| 08 Pin               | A-code | M08A08-04-026    | 1000 pcs |

技术参数 / Specifications

| 芯数 / Pin                         | 02 Pin                          | 03 Pin | 04 Pin | 05 Pin | 06 Pin | 08 Pin |
|----------------------------------|---------------------------------|--------|--------|--------|--------|--------|
| 额定电流 / Rated current             | 4 A                             | 4 A    | 4 A    | 4 A    | 2 A    | 2 A    |
| 额定电压 / Rated voltage             | 60 V                            | 60 V   | 60 V   | 30 V   | 60 V   | 60 V   |
| 标准 / Standard                    | IEC 61076-2-104                 |        |        |        |        |        |
| 接线方式 / Termination               | 焊线 / Solder                     |        |        |        |        |        |
| 锁紧方式 / Connect locking system    | 螺纹锁紧 / Screw Lock               |        |        |        |        |        |
| 防护等级 / Degree of protection      | IP67 / IP68                     |        |        |        |        |        |
| 插拔次数 / Mechanical durability     | 500次                            |        |        |        |        |        |
| 工作温度 / Operation temperature     | -25 °C ~ +85 °C                 |        |        |        |        |        |
| 接触电阻 / Contact resistance        | ≤ 10mΩ                          |        |        |        |        |        |
| 绝缘电阻 / Insulation resistance     | ≥ 1000MΩ                        |        |        |        |        |        |
| 胶芯材料 / Housing material          | 尼龙PA66                          |        |        |        |        |        |
| 端子材料 / Pin material              | 黄铜镀金 / Brass With Gold Plated   |        |        |        |        |        |
| 螺母和铜壳材料 / Nut and shell material | 黄铜镀镍 / Brass With Nickel Plated |        |        |        |        |        |
| 胶圈材料 / Gasket material           | 氟胶圈 / Fluorine Ring             |        |        |        |        |        |
| 黑色胶水 / Black glue                | 环氧树脂 / Epoxy resin              |        |        |        |        |        |

## M8后锁面板式板端公头 焊板型M8 SW10T-13.7L后灌胶

产品图 / Product photo



尺寸图 / Dimension

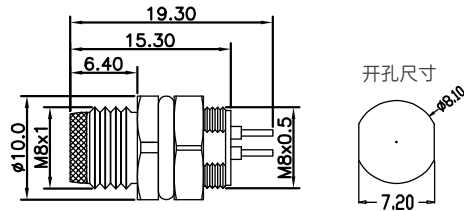

针位分布前视图 / Pin assignment front view

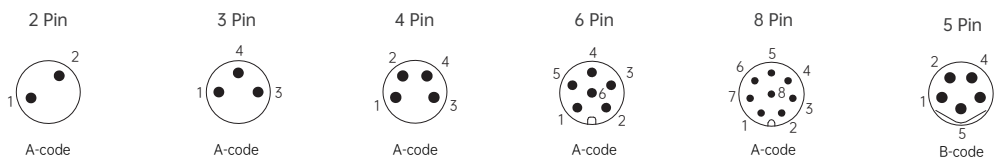

订货信息 / Order daec

| 芯数 / Number of cores | Coding | 料号 / Part number | Qty      |
|----------------------|--------|------------------|----------|
| 02 Pin               | A-code | M08A02-03-044    | 1000 pcs |
| 03 Pin               | A-code | M08A03-03-044    | 1000 pcs |
| 04 Pin               | A-code | M08A04-03-044    | 1000 pcs |
| 05 Pin               | B-code | M08B05-03-044    | 1000 pcs |
| 06 Pin               | A-code | M08A06-03-044    | 1000 pcs |
| 08 Pin               | A-code | M08A08-03-044    | 1000 pcs |

技术参数 / Specifications

| 芯数 / Pin                         | 02 Pin                          | 03 Pin | 04 Pin | 05 Pin | 06 Pin | 08 Pin |
|----------------------------------|---------------------------------|--------|--------|--------|--------|--------|
| 额定电流 / Rated current             | 4 A                             | 4 A    | 4 A    | 4 A    | 2 A    | 2 A    |
| 额定电压 / Rated voltage             | 60 V                            | 60 V   | 60 V   | 30 V   | 60 V   | 60 V   |
| 标准 / Standard                    | IEC 61076-2-104                 |        |        |        |        |        |
| 接线方式 / Termination               | 浸焊 / Dip-Solder                 |        |        |        |        |        |
| 锁紧方式 / Connect locking system    | 螺纹锁紧 / Screw Lock               |        |        |        |        |        |
| 防护等级 / Degree of protection      | IP67 / IP68                     |        |        |        |        |        |
| 插拔次数 / Mechanical durability     | 500次                            |        |        |        |        |        |
| 工作温度 / Operation temperature     | -25 °C ~ +85 °C                 |        |        |        |        |        |
| 接触电阻 / Contact resistance        | ≤ 10mΩ                          |        |        |        |        |        |
| 绝缘电阻 / Insulation resistance     | ≥ 1000MΩ                        |        |        |        |        |        |
| 胶芯材料 / Housing material          | 尼龙PA66                          |        |        |        |        |        |
| 端子材料 / Pin material              | 黄铜镀金 / Brass With Gold Plated   |        |        |        |        |        |
| 螺母和铜壳材料 / Nut and shell material | 黄铜镀镍 / Brass With Nickel Plated |        |        |        |        |        |
| 胶圈材料 / Gasket material           | 氟胶圈 / Fluorine Ring             |        |        |        |        |        |
| 黑色胶水 / Black glue                | 环氧树脂 / Epoxy resin              |        |        |        |        |        |

## M8成型式线端公头C款 焊线型+9\*11.3L网纹螺丝

产品图 / Product photo



尺寸图 / Dimension

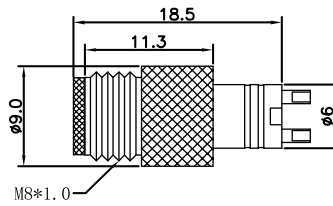

针位分布前视图 / Pin assignment front view

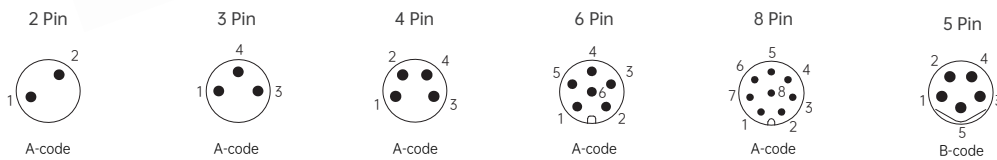

订货信息 / Order daec

| 芯数 / Number of cores | Coding | 料号 / Part number | Qty      |
|----------------------|--------|------------------|----------|
| 02 Pin               | A-code | M08A02-07-008    | 1000 pcs |
| 03 Pin               | A-code | M08A03-07-008    | 1000 pcs |
| 04 Pin               | A-code | M08A04-07-008    | 1000 pcs |
| 05 Pin               | B-code | M08B05-07-008    | 1000 pcs |
| 06 Pin               | A-code | M08A06-07-008    | 1000 pcs |
| 08 Pin               | A-code | M08A08-07-008    | 1000 pcs |

技术参数 / Specifications

| 芯数 / Pin   | 02 Pin                                    | 03 Pin                                    | 04 Pin                                    | 05 Pin              | 06 Pin              | 08 Pin              |
|--|---|---|---|---------------------|---------------------|---------------------|
| 额定电流 / Rated current                                 | 4 A                                       | 4 A                                       | 4 A                                       | 4 A                 | 2 A                 | 2 A                 |
| 额定电压 / Rated voltage                                 | 60 V                                      | 60 V                                      | 60 V                                      | 60 V                | 30 V                | 30 V                |
| 线规 (mm <sup>2</sup> ) / Wire gauge(mm <sup>2</sup> ) | 0.14mm <sup>2</sup> ~ 0.34mm <sup>2</sup> | 0.14mm <sup>2</sup> ~ 0.34mm <sup>2</sup> | 0.14mm <sup>2</sup> ~ 0.34mm <sup>2</sup> | 0.14mm <sup>2</sup> | 0.14mm <sup>2</sup> | 0.14mm <sup>2</sup> |
| 线号 (AWG) / Wire gauge(AWG)                           | 26AWG ~ 22AWG                             | 26AWG ~ 22AWG                             | 26AWG ~ 22AWG                             | 26AWG               | 26AWG               | 26AWG               |
| 标准 / Standard  | IEC 61076-2-104                           |   |   |                     |                     |                     |
| 接线方式 / Termination                                   | 焊线 / Solder                               |   |   |                     |                     |                     |
| 锁紧方式 / Connect locking system                        | 螺纹锁紧 / Screw Lock                         |   |   |                     |                     |                     |
| 防护等级 / Degree of protection                          | IP67 / IP68                               |   |   |                     |                     |                     |
| 插拔次数 / Mechanical durability                         | 500次                                      |   |   |                     |                     |                     |
| 工作温度 / Operation temperature                         | -25 °C ~ +85 °C                           |   |   |                     |                     |                     |
| 接触电阻 / Contact resistance                            | ≤ 10mΩ                                    |   |   |                     |                     |                     |
| 绝缘电阻 / Insulation resistance                         | ≥ 1000MΩ                                  |   |   |                     |                     |                     |
| 胶芯材料 / Housing material                              | 尼龙PA66                                    |   |   |                     |                     |                     |
| 端子材料 / Pin material                                  | 黄铜镀金 / Brass With Gold Plated             |   |   |                     |                     |                     |
| 螺丝材料 / Screw   | 黄铜镀镍 / Brass With Nickel Plated           |   |   |                     |                     |                     |



## M8成型式线端母头 焊线型+9\*7.8L网纹螺母

产品图 / Product photo



尺寸图 / Dimension

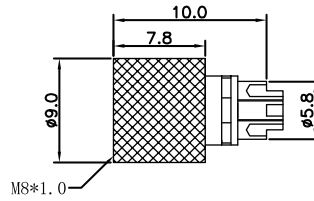

针位分布前视图 / Pin assignment front view

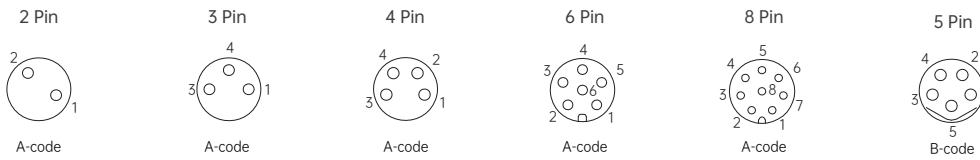

订货信息 / Order daec

| 芯数 / Number of cores | Coding | 料号 / Part number | Qty      |
|----------------------|--------|------------------|----------|
| 02 Pin               | A-code | M08A02-08-009    | 1000 pcs |
| 03 Pin               | A-code | M08A03-08-009    | 1000 pcs |
| 04 Pin               | A-code | M08A04-08-009    | 1000 pcs |
| 05 Pin               | B-code | M08B05-08-009    | 1000 pcs |
| 06 Pin               | A-code | M08A06-08-009    | 1000 pcs |
| 08 Pin               | A-code | M08A08-08-009    | 1000 pcs |

技术参数 / Specifications

| 芯数 / Pin   | 02 Pin                                    | 03 Pin                                    | 04 Pin                                    | 05 Pin              | 06 Pin              | 08 Pin              |
|--|---|---|---|---------------------|---------------------|---------------------|
| 额定电流 / Rated current                                 | 4 A                                       | 4 A                                       | 4 A                                       | 4 A                 | 2 A                 | 2 A                 |
| 额定电压 / Rated voltage                                 | 60 V                                      | 60 V                                      | 60 V                                      | 60 V                | 30 V                | 30 V                |
| 线规 (mm <sup>2</sup> ) / Wire gauge(mm <sup>2</sup> ) | 0.14mm <sup>2</sup> ~ 0.34mm <sup>2</sup> | 0.14mm <sup>2</sup> ~ 0.34mm <sup>2</sup> | 0.14mm <sup>2</sup> ~ 0.34mm <sup>2</sup> | 0.14mm <sup>2</sup> | 0.14mm <sup>2</sup> | 0.14mm <sup>2</sup> |
| 线号 (AWG) / Wire gauge(AWG)                           | 26AWG ~ 22AWG                             | 26AWG ~ 22AWG                             | 26AWG ~ 22AWG                             | 26AWG               | 26AWG               | 26AWG               |
| 标准 / Standard  | IEC 61076-2-104                           |   |   |                     |                     |                     |
| 接线方式 / Termination                                   | 焊线 / Solder                               |   |   |                     |                     |                     |
| 锁紧方式 / Connect locking system                        | 螺纹锁紧 / Screw Lock                         |   |   |                     |                     |                     |
| 防护等级 / Degree of protection                          | IP67 / IP68                               |   |   |                     |                     |                     |
| 插拔次数 / Mechanical durability                         | 500次                                      |   |   |                     |                     |                     |
| 工作温度 / Operation temperature                         | -25 °C ~ +85 °C                           |   |   |                     |                     |                     |
| 接触电阻 / Contact resistance                            | ≤ 10mΩ                                    |   |   |                     |                     |                     |
| 绝缘电阻 / Insulation resistance                         | ≥ 1000MΩ                                  |   |   |                     |                     |                     |
| 胶芯材料 / Housing material                              | 尼龙PA66                                    |   |   |                     |                     |                     |
| 端子材料 / Pin material                                  | 黄铜镀金 / Brass With Gold Plated             |   |   |                     |                     |                     |
| 螺丝材料 / Screw   | 黄铜镀镍 / Brass With Nickel Plated           |   |   |                     |                     |                     |

## M8成型式线端公头 焊线型+11.3L防振动六角螺丝

产品图 / Product photo



尺寸图 / Dimension

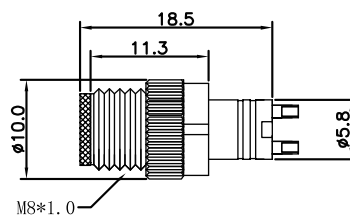

针位分布前视图 / Pin assignment front view

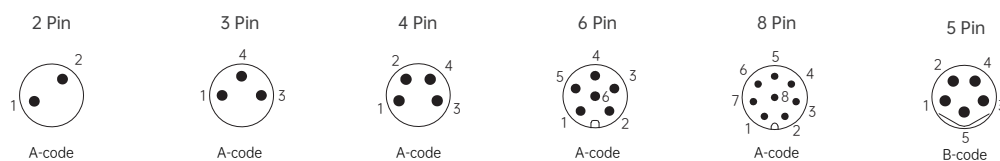

订货信息 / Order daec

| 芯数 / Number of cores | Coding | 料号 / Part number | Qty      |
|----------------------|--------|------------------|----------|
| 02 Pin               | A-code | M08A02-07-009    | 1000 pcs |
| 03 Pin               | A-code | M08A03-07-009    | 1000 pcs |
| 04 Pin               | A-code | M08A04-07-009    | 1000 pcs |
| 05 Pin               | B-code | M08B05-07-009    | 1000 pcs |
| 06 Pin               | A-code | M08A06-07-009    | 1000 pcs |
| 08 Pin               | A-code | M08A08-07-009    | 1000 pcs |

技术参数 / Specifications

| 芯数 / Pin   | 02 Pin                                    | 03 Pin                                    | 04 Pin                                    | 05 Pin              | 06 Pin              | 08 Pin              |
|--|---|---|---|---------------------|---------------------|---------------------|
| 额定电流 / Rated current                                 | 4 A                                       | 4 A                                       | 4 A                                       | 4 A                 | 2 A                 | 2 A                 |
| 额定电压 / Rated voltage                                 | 60 V                                      | 60 V                                      | 60 V                                      | 30 V                | 60 V                | 60 V                |
| 线规 (mm <sup>2</sup> ) / Wire gauge(mm <sup>2</sup> ) | 0.14mm <sup>2</sup> ~ 0.34mm <sup>2</sup> | 0.14mm <sup>2</sup> ~ 0.34mm <sup>2</sup> | 0.14mm <sup>2</sup> ~ 0.34mm <sup>2</sup> | 0.14mm <sup>2</sup> | 0.14mm <sup>2</sup> | 0.14mm <sup>2</sup> |
| 线号 (AWG) / Wire gauge(AWG)                           | 26AWG ~ 22AWG                             | 26AWG ~ 22AWG                             | 26AWG ~ 22AWG                             | 26AWG               | 26AWG               | 26AWG               |
| 标准 / Standard  | IEC 61076-2-104                           |   |   |                     |                     |                     |
| 接线方式 / Termination                                   | 焊线 / Solder                               |   |   |                     |                     |                     |
| 锁紧方式 / Connect locking system                        | 螺纹锁紧 / Screw Lock                         |   |   |                     |                     |                     |
| 防护等级 / Degree of protection                          | IP67 / IP68                               |   |   |                     |                     |                     |
| 插拔次数 / Mechanical durability                         | 500次                                      |   |   |                     |                     |                     |
| 工作温度 / Operation temperature                         | -25 °C ~ +85 °C                           |   |   |                     |                     |                     |
| 接触电阻 / Contact resistance                            | ≤ 10mΩ                                    |   |   |                     |                     |                     |
| 绝缘电阻 / Insulation resistance                         | ≥ 1000MΩ                                  |   |   |                     |                     |                     |
| 胶芯材料 / Housing material                              | 尼龙PA66                                    |   |   |                     |                     |                     |
| 端子材料 / Pin material                                  | 黄铜镀金 / Brass With Gold Plated             |   |   |                     |                     |                     |
| 螺丝材料 / Screw   | 黄铜镀镍 / Brass With Nickel Plated           |   |   |                     |                     |                     |

## M8成型式线端母头 焊线型+8L防振动六角螺母+防水圈

产品图 / Product photo



尺寸图 / Dimension

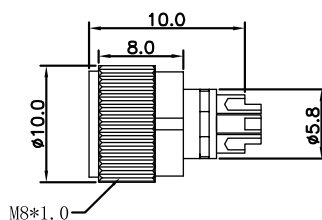

针位分布前视图 / Pin assignment front view

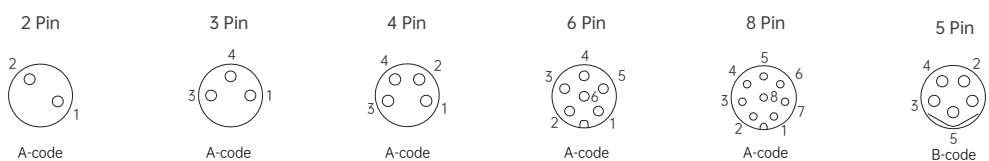

订货信息 / Order daec

| 芯数 / Number of cores | Coding | 料号 / Part number | Qty      |
|----------------------|--------|------------------|----------|
| 02 Pin               | A-code | M08A02-08-010    | 1000 pcs |
| 03 Pin               | A-code | M08A03-08-010    | 1000 pcs |
| 04 Pin               | A-code | M08A04-08-010    | 1000 pcs |
| 05 Pin               | B-code | M08B05-08-010    | 1000 pcs |
| 06 Pin               | A-code | M08A06-08-010    | 1000 pcs |
| 08 Pin               | A-code | M08A08-08-010    | 1000 pcs |

技术参数 / Specifications

| 芯数 / Pin   | 02 Pin                                    | 03 Pin                                    | 04 Pin                                    | 05 Pin              | 06 Pin              | 08 Pin              |
|--|---|---|---|---------------------|---------------------|---------------------|
| 额定电流 / Rated current                                 | 4 A                                       | 4 A                                       | 4 A                                       | 4 A                 | 2 A                 | 2 A                 |
| 额定电压 / Rated voltage                                 | 60 V                                      | 60 V                                      | 60 V                                      | 30 V                | 60 V                | 60 V                |
| 线规 (mm <sup>2</sup> ) / Wire gauge(mm <sup>2</sup> ) | 0.14mm <sup>2</sup> ~ 0.34mm <sup>2</sup> | 0.14mm <sup>2</sup> ~ 0.34mm <sup>2</sup> | 0.14mm <sup>2</sup> ~ 0.34mm <sup>2</sup> | 0.14mm <sup>2</sup> | 0.14mm <sup>2</sup> | 0.14mm <sup>2</sup> |
| 线号 (AWG) / Wire gauge(AWG)                           | 26AWG ~ 22AWG                             | 26AWG ~ 22AWG                             | 26AWG ~ 22AWG                             | 26AWG               | 26AWG               | 26AWG               |
| 标准 / Standard  | IEC 61076-2-104                           |   |   |                     |                     |                     |
| 接线方式 / Termination                                   | 焊线 / Solder                               |   |   |                     |                     |                     |
| 锁紧方式 / Connect locking system                        | 螺纹锁紧 / Screw Lock                         |   |   |                     |                     |                     |
| 防护等级 / Degree of protection                          | IP67 / IP68                               |   |   |                     |                     |                     |
| 插拔次数 / Mechanical durability                         | 500次                                      |   |   |                     |                     |                     |
| 工作温度 / Operation temperature                         | -25 °C ~ +85 °C                           |   |   |                     |                     |                     |
| 接触电阻 / Contact resistance                            | ≤ 10mΩ                                    |   |   |                     |                     |                     |
| 绝缘电阻 / Insulation resistance                         | ≥ 1000MΩ                                  |   |   |                     |                     |                     |
| 胶芯材料 / Housing material                              | 尼龙PA66                                    |   |   |                     |                     |                     |
| 端子材料 / Pin material                                  | 黄铜镀金 / Brass With Gold Plated             |   |   |                     |                     |                     |
| 螺丝材料 / Screw   | 黄铜镀镍 / Brass With Nickel Plated           |   |   |                     |                     |                     |

## M8成型式线端公头焊线型 屏蔽款+11L弹簧直纹螺丝

产品图 / Product photo



尺寸图 / Dimension

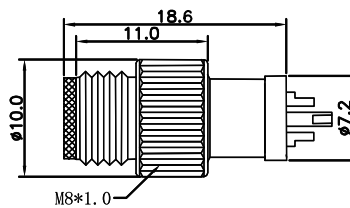

针位分布前视图 / Pin assignment front view

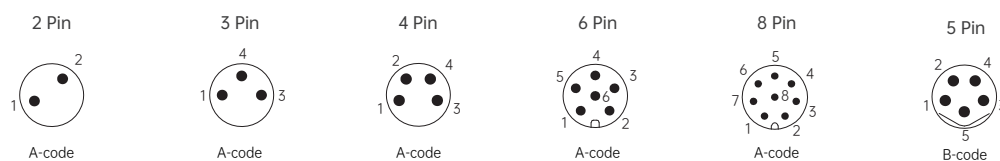

订货信息 / Order daec

| 芯数 / Number of cores | Coding | 料号 / Part number | Qty      |
|----------------------|--------|------------------|----------|
| 02 Pin               | A-code | M08A02-07-010    | 1000 pcs |
| 03 Pin               | A-code | M08A03-07-010    | 1000 pcs |
| 04 Pin               | A-code | M08A04-07-010    | 1000 pcs |
| 05 Pin               | B-code | M08B05-07-010    | 1000 pcs |
| 06 Pin               | A-code | M08A06-07-010    | 1000 pcs |
| 08 Pin               | A-code | M08A08-07-010    | 1000 pcs |

技术参数 / Specifications

| 芯数 / Pin   | 02 Pin                                    | 03 Pin                                    | 04 Pin                                    | 05 Pin              | 06 Pin              | 08 Pin              |
|--|---|---|---|---------------------|---------------------|---------------------|
| 额定电流 / Rated current                                 | 4 A                                       | 4 A                                       | 4 A                                       | 4 A                 | 2 A                 | 2 A                 |
| 额定电压 / Rated voltage                                 | 60 V                                      | 60 V                                      | 60 V                                      | 30 V                | 60 V                | 60 V                |
| 线规 (mm <sup>2</sup> ) / Wire gauge(mm <sup>2</sup> ) | 0.14mm <sup>2</sup> ~ 0.34mm <sup>2</sup> | 0.14mm <sup>2</sup> ~ 0.34mm <sup>2</sup> | 0.14mm <sup>2</sup> ~ 0.34mm <sup>2</sup> | 0.14mm <sup>2</sup> | 0.14mm <sup>2</sup> | 0.14mm <sup>2</sup> |
| 线号 (AWG) / Wire gauge(AWG)                           | 26AWG ~ 22AWG                             | 26AWG ~ 22AWG                             | 26AWG ~ 22AWG                             | 26AWG               | 26AWG               | 26AWG               |
| 标准 / Standard  | IEC 61076-2-104                           |   |   |                     |                     |                     |
| 接线方式 / Termination                                   | 焊线 / Solder                               |   |   |                     |                     |                     |
| 锁紧方式 / Connect locking system                        | 螺纹锁紧 / Screw Lock                         |   |   |                     |                     |                     |
| 防护等级 / Degree of protection                          | IP67 / IP68                               |   |   |                     |                     |                     |
| 插拔次数 / Mechanical durability                         | 500次                                      |   |   |                     |                     |                     |
| 工作温度 / Operation temperature                         | -25 °C ~ +85 °C                           |   |   |                     |                     |                     |
| 接触电阻 / Contact resistance                            | ≤ 10mΩ                                    |   |   |                     |                     |                     |
| 绝缘电阻 / Insulation resistance                         | ≥ 1000MΩ                                  |   |   |                     |                     |                     |
| 胶芯材料 / Housing material                              | 尼龙PA66                                    |   |   |                     |                     |                     |
| 端子材料 / Pin material                                  | 黄铜镀金 / Brass With Gold Plated             |   |   |                     |                     |                     |
| 螺丝材料 / Screw   | 黄铜镀镍 / Brass With Nickel Plated           |   |   |                     |                     |                     |
| 屏蔽管材料 / Spring                                       | 黄铜镀镍 / Brass With Nickel Plated           |   |   |                     |                     |                     |

## M8成型式线端母头 焊线型屏蔽款+8L弹簧直纹螺母

产品图 / Product photo



尺寸图 / Dimension

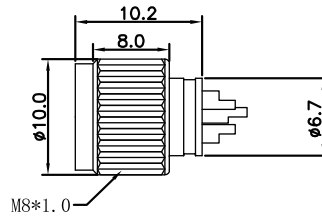

针位分布前视图 / Pin assignment front view

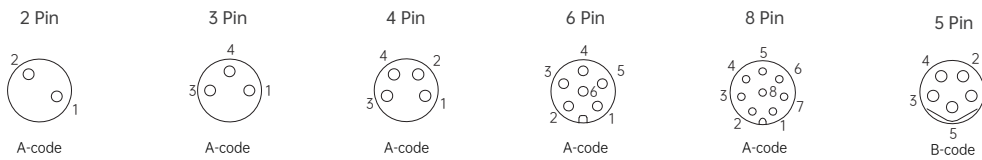

订货信息 / Order daec

| 芯数 / Number of cores | Coding | 料号 / Part number | Qty      |
|----------------------|--------|------------------|----------|
| 02 Pin               | A-code | M08A02-08-011    | 1000 pcs |
| 03 Pin               | A-code | M08A03-08-011    | 1000 pcs |
| 04 Pin               | A-code | M08A04-08-011    | 1000 pcs |
| 05 Pin               | B-code | M08B05-08-011    | 1000 pcs |
| 06 Pin               | A-code | M08A06-08-011    | 1000 pcs |
| 08 Pin               | A-code | M08A08-08-011    | 1000 pcs |

技术参数 / Specifications

| 芯数 / Pin   | 02 Pin                                    | 03 Pin                                    | 04 Pin                                    | 05 Pin              | 06 Pin              | 08 Pin              |
|--|---|---|---|---------------------|---------------------|---------------------|
| 额定电流 / Rated current                                 | 4 A                                       | 4 A                                       | 4 A                                       | 4 A                 | 2 A                 | 2 A                 |
| 额定电压 / Rated voltage                                 | 60 V                                      | 60 V                                      | 60 V                                      | 30 V                | 60 V                | 60 V                |
| 线规 (mm <sup>2</sup> ) / Wire gauge(mm <sup>2</sup> ) | 0.14mm <sup>2</sup> ~ 0.34mm <sup>2</sup> | 0.14mm <sup>2</sup> ~ 0.34mm <sup>2</sup> | 0.14mm <sup>2</sup> ~ 0.34mm <sup>2</sup> | 0.14mm <sup>2</sup> | 0.14mm <sup>2</sup> | 0.14mm <sup>2</sup> |
| 线号 (AWG) / Wire gauge(AWG)                           | 26AWG ~ 22AWG                             | 26AWG ~ 22AWG                             | 26AWG ~ 22AWG                             | 26AWG               | 26AWG               | 26AWG               |
| 标准 / Standard  | IEC 61076-2-104                           |   |   |                     |                     |                     |
| 接线方式 / Termination                                   | 焊线 / Solder                               |   |   |                     |                     |                     |
| 锁紧方式 / Connect locking system                        | 螺纹锁紧 / Screw Lock                         |   |   |                     |                     |                     |
| 防护等级 / Degree of protection                          | IP67 / IP68                               |   |   |                     |                     |                     |
| 插拔次数 / Mechanical durability                         | 500次                                      |   |   |                     |                     |                     |
| 工作温度 / Operation temperature                         | -25 °C ~ +85 °C                           |   |   |                     |                     |                     |
| 接触电阻 / Contact resistance                            | ≤ 10mΩ                                    |   |   |                     |                     |                     |
| 绝缘电阻 / Insulation resistance                         | ≥ 1000MΩ                                  |   |   |                     |                     |                     |
| 胶芯材料 / Housing material                              | 尼龙PA66                                    |   |   |                     |                     |                     |
| 端子材料 / Pin material                                  | 黄铜镀金 / Brass With Gold Plated             |   |   |                     |                     |                     |
| 螺丝材料 / Screw   | 黄铜镀镍 / Brass With Nickel Plated           |   |   |                     |                     |                     |

## M8成型式线端公头 焊线型全屏蔽款+9.8L直纹螺丝

产品图 / Product photo



尺寸图 / Dimension

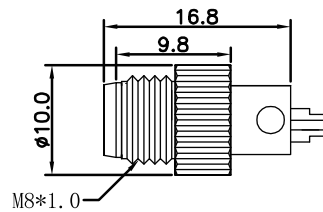

针位分布前视图 / Pin assignment front view

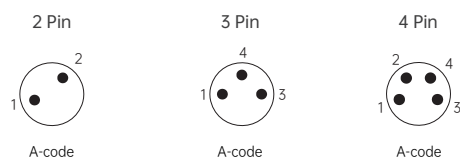

订货信息 / Order daec

| 芯数 / Number of cores | Coding | 料号 / Part number | Qty      |
|----------------------|--------|------------------|----------|
| 02 Pin               | A-code | M08A02-07-011    | 1000 pcs |
| 03 Pin               | A-code | M08A03-07-011    | 1000 pcs |
| 04 Pin               | A-code | M08A04-07-011    | 1000 pcs |

技术参数 / Specifications

| 芯数 / Pin   | 02 Pin                                    | 03 Pin                                    | 04 Pin                                    |
|--|---|---|---|
| 额定电流 / Rated current                                 | 4 A                                       | 4 A                                       | 4 A                                       |
| 额定电压 / Rated voltage                                 | 60 V                                      | 60 V                                      | 60 V                                      |
| 线规 (mm <sup>2</sup> ) / Wire gauge(mm <sup>2</sup> ) | 0.14mm <sup>2</sup> ~ 0.34mm <sup>2</sup> | 0.14mm <sup>2</sup> ~ 0.34mm <sup>2</sup> | 0.14mm <sup>2</sup> ~ 0.34mm <sup>2</sup> |
| 线号 (AWG) / Wire gauge(AWG)                           | 26AWG ~ 22AWG                             | 26AWG ~ 22AWG                             | 26AWG ~ 22AWG                             |
| 标准 / Standard  | IEC 61076-2-104                           |   |   |
| 接线方式 / Termination                                   | 焊线 / Solder                               |   |   |
| 锁紧方式 / Connect locking system                        | 螺纹锁紧 / Screw Lock                         |   |   |
| 防护等级 / Degree of protection                          | IP67 / IP68                               |   |   |
| 插拔次数 / Mechanical durability                         | 500次                                      |   |   |
| 工作温度 / Operation temperature                         | -25 °C ~ +85 °C                           |   |   |
| 接触电阻 / Contact resistance                            | ≤ 10mΩ                                    |   |   |
| 绝缘电阻 / Insulation resistance                         | ≥ 1000MΩ                                  |   |   |
| 胶芯材料 / Housing material                              | 尼龙PA66                                    |   |   |
| 端子材料 / Pin material                                  | 黄铜镀金 / Brass With Gold Plated             |   |   |
| 屏蔽管材料 / Spring                                       | 黄铜镀镍 / Brass With Nickel Plated           |   |   |

## M8公直头成型式线束 屏蔽/非屏蔽 线长L可定制

产品图 / Product photo



尺寸图 / Dimension

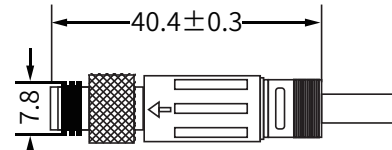

针位分布前视图 / Pin assignment front view

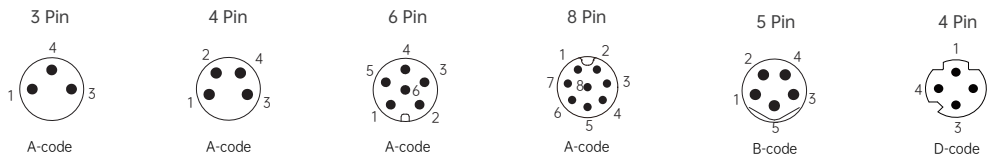

订货信息 / Order daea

| 芯数 / Contacts | 编码 / Code | 产品料号 ("L"表示长度, 单位毫米mm) / Part number ("L" is length millimetre mm) |                   |                   |                   |
|---------------|-----------|--|-------------------|-------------------|-------------------|
|               |           | 1: PVC 无屏蔽   | 2: PUR 无屏蔽        | 3: PVC 带屏蔽        | 4: PUR 带屏蔽        |
| 03 Pin        | A-code    | M08A03-09-010-1-L  | M08A03-09-010-2-L | M08A03-09-010-3-L | M08A03-09-010-4-L |
| 04 Pin        | A-code    | M08A04-09-010-1-L  | M08A04-09-010-2-L | M08A04-09-010-3-L | M08A04-09-010-4-L |
| 04 Pin        | D-code    | M08D04-09-010-1-L  | M08D04-09-010-2-L | M08D04-09-010-3-L | M08D04-09-010-4-L |
| 05 Pin        | B-code    | M08B05-09-010-1-L  | M08B05-09-010-2-L | M08B05-09-010-3-L | M08B05-09-010-4-L |
| 06 Pin        | A-code    | M08A06-09-010-1-L  | M08A06-09-010-2-L | M08A06-09-010-3-L | M08A06-09-010-4-L |
| 08 Pin        | A-code    | M08A08-09-010-1-L  | M08A08-09-010-2-L | M08A08-09-010-3-L | M08A08-09-010-4-L |

技术参数 / Specifications

| 芯数 / Pin                                | 03 Pin  | 04 Pin | 04 Pin | 05 Pin | 06 Pin | 08 Pin |
|---|---|--------|--------|--------|--------|--------|
| 编码 / Code                               | A 编码  | A 编码   | D 编码   | B 编码   | A 编码   | A 编码   |
| 额定电流 / Rated current                    | 3 A   | 3 A    | 4 A    | 3 A    | 1 A    | 1 A    |
| 额定电压 / Rated voltage                    | 60 V  | 30 V   | 30 V   | 30 V   | 30 V   | 30 V   |
| 线规 (平方数) / Wire gauge(mm <sup>2</sup> ) | 0.25  | 0.25   | 0.25   | 0.25   | 0.14   | 0.14   |
| 线号 / Wire gauge(AWG)                    | 24  | 24     | 24     | 24     | 26     | 26     |
| 标准 / Standard                           | IEC 61076-2-104   |        |        |        |        |        |
| 接线方式 / Termination                      | 焊接和成型 /Welding And Forming  |        |        |        |        |        |
| 锁紧方式 / Connect locking system           | 螺纹锁紧 / Screw Lock   |        |        |        |        |        |
| 防护等级 / Degree of protection             | IP67 / IP68   |        |        |        |        |        |
| 插拔次数 / Mechanical durability            | 500 次   |        |        |        |        |        |
| 工作温度 / Operation temperature            | -25 °C ~ +85 °C   |        |        |        |        |        |
| 接触电阻 / Contact resistance               | ≤ 10mΩ  |        |        |        |        |        |
| 绝缘电阻 / Insulation resistance            | ≥ 1000MΩ  |        |        |        |        |        |
| 胶芯材料 / Housing material                 | 尼龙PA66  |        |        |        |        |        |
| 端子材料 / Pin material                     | 黄铜镀金/磷铜镀金 / Brass With Gold Plated / Phosphor Bronze With Gold Plated |        |        |        |        |        |
| 壳体材料 / Outer shell material             | 铜合金 / Copper Alloy  |        |        |        |        |        |
| 成型材料 / Over-mold material               | PVC / PUR   |        |        |        |        |        |

## M8母直头成型式线束 屏蔽/非屏蔽 线长L可定制

产品图 / Product photo



尺寸图 / Dimension

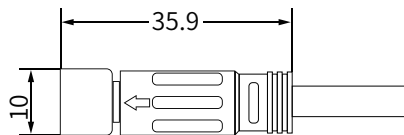

针位分布前视图 / Pin assignment front view

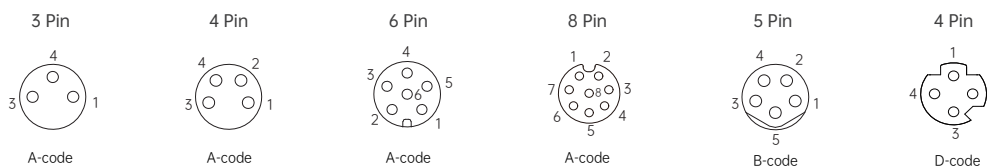

订货信息 / Order daea

| 芯数 / Contacts | 编码 / Code | 产品料号("L"表示长度, 单位毫米mm) / Part number ("L" is length millimetre mm) |                   |                   |                   |
|---------------|-----------|---|-------------------|-------------------|-------------------|
|               |           | 1: PVC 无屏蔽  | 2: PUR 无屏蔽        | 3: PVC 带屏蔽        | 4: PUR 带屏蔽        |
| 03 Pin        | A-code    | M08A03-10-010-1-L   | M08A03-10-010-2-L | M08A03-10-010-3-L | M08A03-10-010-4-L |
| 04 Pin        | A-code    | M08A04-10-010-1-L   | M08A04-10-010-2-L | M08A04-10-010-3-L | M08A04-10-010-4-L |
| 04 Pin        | D-code    | M08D04-10-010-1-L   | M08D04-10-010-2-L | M08D04-10-010-3-L | M08D04-10-010-4-L |
| 05 Pin        | B-code    | M08B05-10-010-1-L   | M08B05-10-010-2-L | M08B05-10-010-3-L | M08B05-10-010-4-L |
| 06 Pin        | A-code    | M08A06-10-010-1-L   | M08A06-10-010-2-L | M08A06-10-010-3-L | M08A06-10-010-4-L |
| 08 Pin        | A-code    | M08A08-10-010-1-L   | M08A08-10-010-2-L | M08A08-10-010-3-L | M08A08-10-010-4-L |

技术参数 / Specifications

| 芯数 / Pin                                | 03 Pin  | 04 Pin | 04 Pin | 05 Pin | 06 Pin | 08 Pin |
|---|---|--------|--------|--------|--------|--------|
| 编码 / Code                               | A 编码  | A 编码   | D 编码   | B 编码   | A 编码   | A 编码   |
| 额定电流 / Rated current                    | 3 A   | 3 A    | 4 A    | 3 A    | 1 A    | 1 A    |
| 额定电压 / Rated voltage                    | 60 V  | 30 V   | 30 V   | 30 V   | 30 V   | 30 V   |
| 线规 (平方数) / Wire gauge(mm <sup>2</sup> ) | 0.25  | 0.25   | 0.25   | 0.25   | 0.14   | 0.14   |
| 线号 / Wire gauge(AWG)                    | 24  | 24     | 24     | 24     | 26     | 26     |
| 标准 / Standard                           | IEC 61076-2-104   |        |        |        |        |        |
| 接线方式 / Termination                      | 焊接和成型 /Welding And Forming  |        |        |        |        |        |
| 锁紧方式 / Connect locking system           | 螺纹锁紧 / Screw Lock   |        |        |        |        |        |
| 防护等级 / Degree of protection             | IP67 / IP68   |        |        |        |        |        |
| 插拔次数 / Mechanical durability            | 500 次   |        |        |        |        |        |
| 工作温度 / Operation temperature            | -25 °C ~ +85 °C   |        |        |        |        |        |
| 接触电阻 / Contact resistance               | ≤ 10mΩ  |        |        |        |        |        |
| 绝缘电阻 / Insulation resistance            | ≥ 1000MΩ  |        |        |        |        |        |
| 胶芯材料 / Housing material                 | 尼龙PA66  |        |        |        |        |        |
| 端子材料 / Pin material                     | 黄铜镀金/磷铜镀金 / Brass With Gold Plated / Phosphor Bronze With Gold Plated |        |        |        |        |        |
| 壳体材料 / Outer shell material             | 铜合金 / Copper Alloy  |        |        |        |        |        |
| 成型材料 / Over-mold material               | PVC / PUR   |        |        |        |        |        |



## M8公弯头成型式线束 屏蔽/非屏蔽 线长L可定制

产品图 / Product photo



尺寸图 / Dimension

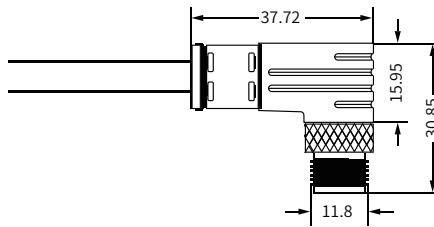

针位分布前视图 / Pin assignment front view

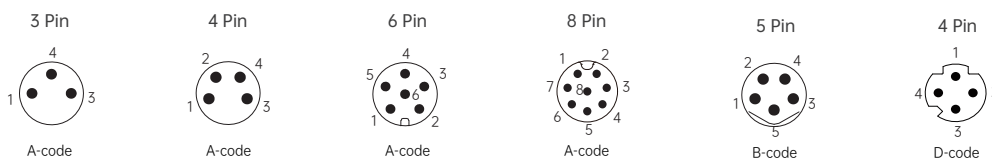

订货信息 / Order daea

| 芯数 / Contacts | 编码 / Code | 产品料号 ("L"表示长度, 单位毫米mm) / Part number ("L" is length millimetre mm) |                   |                   |                   |
|---------------|-----------|--|-------------------|-------------------|-------------------|
|               |           | 1: PVC 无屏蔽   | 2: PUR 无屏蔽        | 3: PVC 带屏蔽        | 4: PUR 带屏蔽        |
| 03 Pin        | A-code    | M08A03-09-011-1-L  | M08A03-09-011-2-L | M08A03-09-011-3-L | M08A03-09-011-4-L |
| 04 Pin        | A-code    | M08A04-09-011-1-L  | M08A04-09-011-2-L | M08A04-09-011-3-L | M08A04-09-011-4-L |
| 04 Pin        | D-code    | M08D04-09-011-1-L  | M08D04-09-011-2-L | M08D04-09-011-3-L | M08D04-09-011-4-L |
| 05 Pin        | B-code    | M08B05-09-011-1-L  | M08B05-09-011-2-L | M08B05-09-011-3-L | M08B05-09-011-4-L |
| 06 Pin        | A-code    | M08A06-09-011-1-L  | M08A06-09-011-2-L | M08A06-09-011-3-L | M08A06-09-011-4-L |
| 08 Pin        | A-code    | M08A08-09-011-1-L  | M08A08-09-011-2-L | M08A08-09-011-3-L | M08A08-09-011-4-L |

技术参数 / Specifications

| 芯数 / Pin                                | 03 Pin  | 04 Pin | 04 Pin | 05 Pin | 06 Pin | 08 Pin |
|---|---|--------|--------|--------|--------|--------|
| 编码 / Code                               | A 编码  | A 编码   | D 编码   | B 编码   | A 编码   | A 编码   |
| 额定电流 / Rated current                    | 3 A   | 3 A    | 4 A    | 3 A    | 1 A    | 1 A    |
| 额定电压 / Rated voltage                    | 60 V  | 30 V   | 30 V   | 30 V   | 30 V   | 30 V   |
| 线规 (平方数) / Wire gauge(mm <sup>2</sup> ) | 0.25  | 0.25   | 0.25   | 0.25   | 0.14   | 0.14   |
| 线号 / Wire gauge(AWG)                    | 24  | 24     | 24     | 24     | 26     | 26     |
| 标准 / Standard                           | IEC 61076-2-104   |        |        |        |        |        |
| 接线方式 / Termination                      | 焊接和成型 /Welding And Forming  |        |        |        |        |        |
| 锁紧方式 / Connect locking system           | 螺纹锁紧 / Screw Lock   |        |        |        |        |        |
| 防护等级 / Degree of protection             | IP67 / IP68   |        |        |        |        |        |
| 插拔次数 / Mechanical durability            | 500 次   |        |        |        |        |        |
| 工作温度 / Operation temperature            | -25 °C ~ +85 °C   |        |        |        |        |        |
| 接触电阻 / Contact resistance               | ≤ 10mΩ  |        |        |        |        |        |
| 绝缘电阻 / Insulation resistance            | ≥ 1000MΩ  |        |        |        |        |        |
| 胶芯材料 / Housing material                 | 尼龙PA66  |        |        |        |        |        |
| 端子材料 / Pin material                     | 黄铜镀金/磷铜镀金 / Brass With Gold Plated / Phosphor Bronze With Gold Plated |        |        |        |        |        |
| 壳体材料 / Outer shell material             | 铜合金 / Copper Alloy  |        |        |        |        |        |
| 成型材料 / Over-mold material               | PVC / PUR   |        |        |        |        |        |

## M8母弯头成型式线束 屏蔽/非屏蔽 线长L可定制

产品图 / Product photo



尺寸图 / Dimension

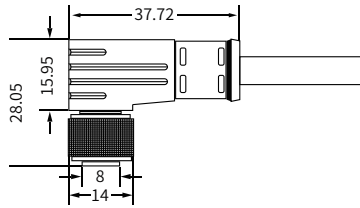

针位分布前视图 / Pin assignment front view

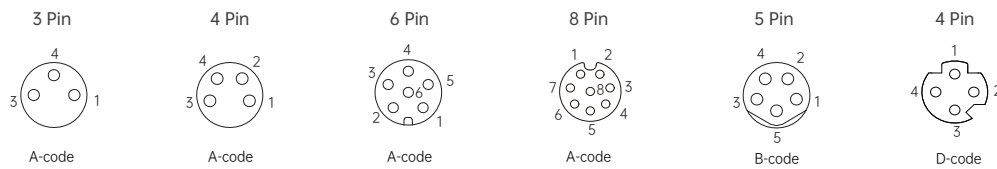

订货信息 / Order daea

| 芯数 / Contacts | 编码 / Code | 产品料号 ("L"表示长度, 单位毫米mm) / Part number ("L" is length millimetre mm) |                   |                   |                   |
|---------------|-----------|--|-------------------|-------------------|-------------------|
|               |           | 1: PVC 无屏蔽   | 2: PUR 无屏蔽        | 3: PVC 带屏蔽        | 4: PUR 带屏蔽        |
| 03 Pin        | A-code    | M08A03-10-011-1-L  | M08A03-10-011-2-L | M08A03-10-011-3-L | M08A03-10-011-4-L |
| 04 Pin        | A-code    | M08A04-10-011-1-L  | M08A04-10-011-2-L | M08A04-10-011-3-L | M08A04-10-011-4-L |
| 04 Pin        | D-code    | M08D04-10-011-1-L  | M08D04-10-011-2-L | M08D04-10-011-3-L | M08D04-10-011-4-L |
| 05 Pin        | B-code    | M08B05-10-011-1-L  | M08B05-10-011-2-L | M08B05-10-011-3-L | M08B05-10-011-4-L |
| 06 Pin        | A-code    | M08A06-10-011-1-L  | M08A06-10-011-2-L | M08A06-10-011-3-L | M08A06-10-011-4-L |
| 08 Pin        | A-code    | M08A08-10-011-1-L  | M08A08-10-011-2-L | M08A08-10-011-3-L | M08A08-10-011-4-L |

技术参数 / Specifications

| 芯数 / Pin                                | 03 Pin  | 04 Pin | 04 Pin | 05 Pin | 06 Pin | 08 Pin |
|---|---|--------|--------|--------|--------|--------|
| 编码 / Code                               | A 编码  | A 编码   | D 编码   | B 编码   | A 编码   | A 编码   |
| 额定电流 / Rated current                    | 3 A   | 3 A    | 4 A    | 3 A    | 1 A    | 1 A    |
| 额定电压 / Rated voltage                    | 60 V  | 30 V   | 30 V   | 30 V   | 30 V   | 30 V   |
| 线规 (平方数) / Wire gauge(mm <sup>2</sup> ) | 0.25  | 0.25   | 0.25   | 0.25   | 0.14   | 0.14   |
| 线号 / Wire gauge(AWG)                    | 24  | 24     | 24     | 24     | 26     | 26     |
| 标准 / Standard                           | IEC 61076-2-104   |        |        |        |        |        |
| 接线方式 / Termination                      | 焊接和成型 /Welding And Forming  |        |        |        |        |        |
| 锁紧方式 / Connect locking system           | 螺纹锁紧 / Screw Lock   |        |        |        |        |        |
| 防护等级 / Degree of protection             | IP67 / IP68   |        |        |        |        |        |
| 插拔次数 / Mechanical durability            | 500 次   |        |        |        |        |        |
| 工作温度 / Operation temperature            | -25 °C ~ +85 °C   |        |        |        |        |        |
| 接触电阻 / Contact resistance               | ≤ 10mΩ  |        |        |        |        |        |
| 绝缘电阻 / Insulation resistance            | ≥ 1000MΩ  |        |        |        |        |        |
| 胶芯材料 / Housing material                 | 尼龙PA66  |        |        |        |        |        |
| 端子材料 / Pin material                     | 黄铜镀金/磷铜镀金 / Brass With Gold Plated / Phosphor Bronze With Gold Plated |        |        |        |        |        |
| 壳体材料 / Outer shell material             | 铜合金 / Copper Alloy  |        |        |        |        |        |
| 成型材料 / Over-mold material               | PVC / PUR   |        |        |        |        |        |



## M9公直头金属款组装式插头 焊线型

产品图 / Product photo



尺寸图 / Dimension

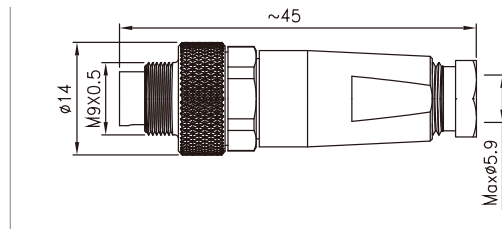

针位分布前视图 / Pin assignment front view

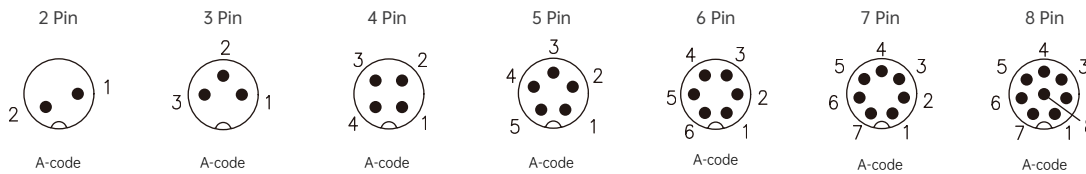

订货信息 / Order daea

| 芯数 / Number of cores | Coding | 料号 / Part number |
|----------------------|--------|------------------|
| 02 Pin               | A-code | M09A02-01-012    |
| 03 Pin               | A-code | M09A03-01-012    |
| 04 Pin               | A-code | M09A04-01-012    |
| 05 Pin               | A-code | M09A05-01-012    |
| 06 Pin               | A-code | M09A06-01-012    |
| 07 Pin               | A-code | M09A07-01-012    |
| 08 Pin               | A-code | M09A08-01-012    |

技术参数 / Specifications

| 芯数 / Pin   | 02 Pin  | 03 Pin              | 04 Pin              | 05 Pin              | 06 Pin              | 07 Pin              | 08 Pin              |
|--|---|---------------------|---------------------|---------------------|---------------------|---------------------|---------------------|
| 额定电流 / Rated current                                 | 4 A   | 4 A                 | 3 A                 | 3 A                 | 1 A                 | 1 A                 | 1 A                 |
| 额定电压 / Rated voltage                                 | A/C (交流) : 125 V D/C (直流) : 125 V                                     |                     |                     |                     |                     |                     |                     |
| 线规 (mm <sup>2</sup> ) / Wire gauge(mm <sup>2</sup> ) | 0.25mm <sup>2</sup>   | 0.25mm <sup>2</sup> | 0.25mm <sup>2</sup> | 0.25mm <sup>2</sup> | 0.14mm <sup>2</sup> | 0.14mm <sup>2</sup> | 0.14mm <sup>2</sup> |
| 线号 (AWG) / Wire gauge(AWG)                           | 24AWG   | 24AWG               | 24AWG               | 24AWG               | 26AWG               | 26AWG               | 26AWG               |
| 壳体材料 / Outer shell material                          | 铜合金 / Copper Alloy  |                     |                     |                     |                     |                     |                     |
| 胶芯材料 / Housing material                              | 尼龙PA66  |                     |                     |                     |                     |                     |                     |
| 成型材料 / Molding material                              | PVC/TPU   |                     |                     |                     |                     |                     |                     |
| 端子材料 / Pin material                                  | 黄铜镀金/磷铜镀金 / Brass With Gold Plated / Phosphor Bronze With Gold Plated |                     |                     |                     |                     |                     |                     |
| 适用温度 / Applicable temperature                        | -40 °C ~ +85 °C   |                     |                     |                     |                     |                     |                     |
| 绝缘电阻 / Insulation resistance                         | ≥ 100MΩ   |                     |                     |                     |                     |                     |                     |
| 接触电阻 / Contact resistance                            | ≤ 3mΩ   |                     |                     |                     |                     |                     |                     |
| 防护等级 / Degree of protection                          | IP67  |                     |                     |                     |                     |                     |                     |
| 插拔次数 / Mechanical durability                         | ≥ 500次  |                     |                     |                     |                     |                     |                     |
| 接线范围 / Wiring range                                  | Φ5mm~Φ8mm   |                     |                     |                     |                     |                     |                     |
| 线材 / Wire rod  | PVC/PUR   |                     |                     |                     |                     |                     |                     |

## M9母直头金属款组装式插头 焊线型

产品图 / Product photo



尺寸图 / Dimension

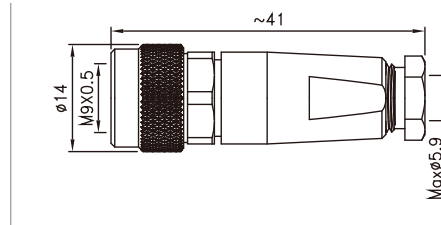

针位分布前视图 / Pin assignment front view

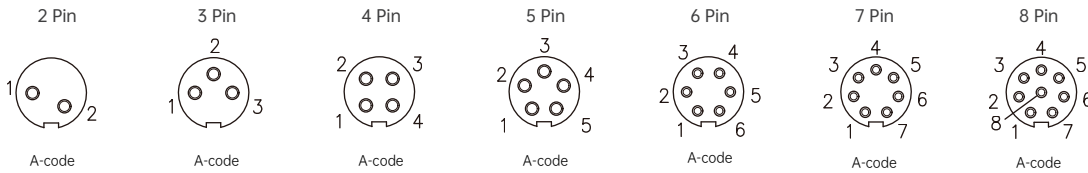

订货信息 / Order daea

| 芯数 / Number of cores | Coding | 料号 / Part number |
|----------------------|--------|------------------|
| 02 Pin               | A-code | M09A02-02-012    |
| 03 Pin               | A-code | M09A03-02-012    |
| 04 Pin               | A-code | M09A04-02-012    |
| 05 Pin               | A-code | M09A05-02-012    |
| 06 Pin               | A-code | M09A06-02-012    |
| 07 Pin               | A-code | M09A07-02-012    |
| 08 Pin               | A-code | M09A08-02-012    |

技术参数 / Specifications

| 芯数 / Pin   | 02 Pin  | 03 Pin              | 04 Pin              | 05 Pin              | 06 Pin              | 07 Pin              | 08 Pin              |
|--|---|---------------------|---------------------|---------------------|---------------------|---------------------|---------------------|
| 额定电流 / Rated current                                 | 4 A   | 4 A                 | 3 A                 | 3 A                 | 1 A                 | 1 A                 | 1 A                 |
| 额定电压 / Rated voltage                                 | A/C (交流) : 125 V D/C (直流) : 125 V                                     |                     |                     |                     |                     |                     |                     |
| 线规 (mm <sup>2</sup> ) / Wire gauge(mm <sup>2</sup> ) | 0.25mm <sup>2</sup>   | 0.25mm <sup>2</sup> | 0.25mm <sup>2</sup> | 0.25mm <sup>2</sup> | 0.14mm <sup>2</sup> | 0.14mm <sup>2</sup> | 0.14mm <sup>2</sup> |
| 线号 (AWG) / Wire gauge(AWG)                           | 24AWG   | 24AWG               | 24AWG               | 24AWG               | 26AWG               | 26AWG               | 26AWG               |
| 壳体材料 / Outer shell material                          | 铜合金 / Copper Alloy  |                     |                     |                     |                     |                     |                     |
| 胶芯材料 / Housing material                              | 尼龙PA66  |                     |                     |                     |                     |                     |                     |
| 成型材料 / Molding material                              | PVC/TPU   |                     |                     |                     |                     |                     |                     |
| 端子材料 / Pin material                                  | 黄铜镀金/磷铜镀金 / Brass With Gold Plated / Phosphor Bronze With Gold Plated |                     |                     |                     |                     |                     |                     |
| 适用温度 / Applicable temperature                        | -40 °C ~ +85 °C   |                     |                     |                     |                     |                     |                     |
| 绝缘电阻 / Insulation resistance                         | ≥ 100MΩ   |                     |                     |                     |                     |                     |                     |
| 接触电阻 / Contact resistance                            | ≤ 3mΩ   |                     |                     |                     |                     |                     |                     |
| 防护等级 / Degree of protection                          | IP67  |                     |                     |                     |                     |                     |                     |
| 插拔次数 / Mechanical durability                         | ≥ 500次  |                     |                     |                     |                     |                     |                     |
| 接线范围 / Wiring range                                  | Φ5mm~Φ8mm   |                     |                     |                     |                     |                     |                     |
| 线材 / Wire rod  | PVC/PUR   |                     |                     |                     |                     |                     |                     |

## M9公弯头金属款组装式插头 焊线型

产品图 / Product photo



尺寸图 / Dimension

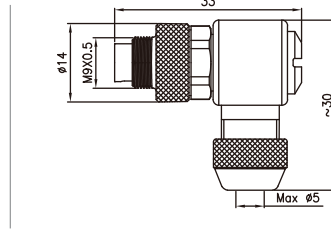

针位分布前视图 / Pin assignment front view

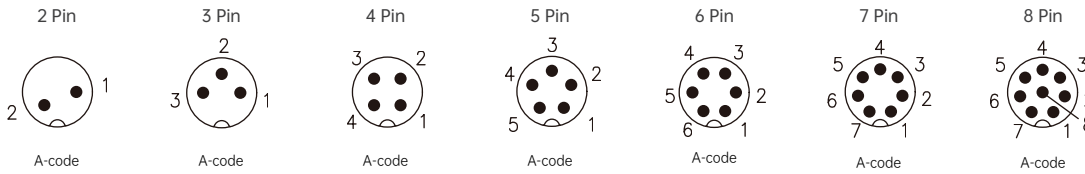

订货信息 / Order daec

| 芯数 / Number of cores | Coding | 料号 / Part number |
|----------------------|--------|------------------|
| 02 Pin               | A-code | M09A02-01-011    |
| 03 Pin               | A-code | M09A03-01-011    |
| 04 Pin               | A-code | M09A04-01-011    |
| 05 Pin               | A-code | M09A05-01-011    |
| 06 Pin               | A-code | M09A06-01-011    |
| 07 Pin               | A-code | M09A07-01-011    |
| 08 Pin               | A-code | M09A08-01-011    |

技术参数 / Specifications

| 芯数 / Pin   | 02 Pin  | 03 Pin              | 04 Pin              | 05 Pin              | 06 Pin              | 07 Pin              | 08 Pin              |
|--|---|---------------------|---------------------|---------------------|---------------------|---------------------|---------------------|
| 额定电流 / Rated current                                 | 4 A   | 4 A                 | 3 A                 | 3 A                 | 1 A                 | 1 A                 | 1 A                 |
| 额定电压 / Rated voltage                                 | A/C (交流) : 125 V D/C (直流) : 125 V                                     |                     |                     |                     |                     |                     |                     |
| 线规 (mm <sup>2</sup> ) / Wire gauge(mm <sup>2</sup> ) | 0.25mm <sup>2</sup>   | 0.25mm <sup>2</sup> | 0.25mm <sup>2</sup> | 0.25mm <sup>2</sup> | 0.14mm <sup>2</sup> | 0.14mm <sup>2</sup> | 0.14mm <sup>2</sup> |
| 线号 (AWG) / Wire gauge(AWG)                           | 24AWG   | 24AWG               | 24AWG               | 24AWG               | 26AWG               | 26AWG               | 26AWG               |
| 壳体材料 / Outer shell material                          | 铜合金 / Copper Alloy  |                     |                     |                     |                     |                     |                     |
| 胶芯材料 / Housing material                              | 尼龙PA66  |                     |                     |                     |                     |                     |                     |
| 成型材料 / Molding material                              | PVC/TPU   |                     |                     |                     |                     |                     |                     |
| 端子材料 / Pin material                                  | 黄铜镀金/磷铜镀金 / Brass With Gold Plated / Phosphor Bronze With Gold Plated |                     |                     |                     |                     |                     |                     |
| 适用温度 / Applicable temperature                        | -40 °C ~ +85 °C   |                     |                     |                     |                     |                     |                     |
| 绝缘电阻 / Insulation resistance                         | ≥ 100MΩ   |                     |                     |                     |                     |                     |                     |
| 接触电阻 / Contact resistance                            | ≤ 3mΩ   |                     |                     |                     |                     |                     |                     |
| 防护等级 / Degree of protection                          | IP67  |                     |                     |                     |                     |                     |                     |
| 插拔次数 / Mechanical durability                         | ≥ 500次  |                     |                     |                     |                     |                     |                     |
| 接线范围 / Wiring range                                  | Φ5mm~Φ8mm   |                     |                     |                     |                     |                     |                     |
| 线材 / Wire rod  | PVC/PUR   |                     |                     |                     |                     |                     |                     |

## M9母弯头金属款组装式插头 焊线型

产品图 / Product photo



尺寸图 / Dimension

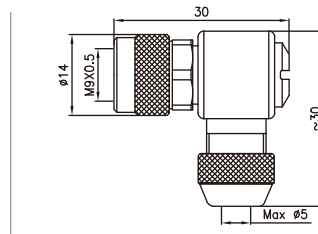

针位分布前视图 / Pin assignment front view

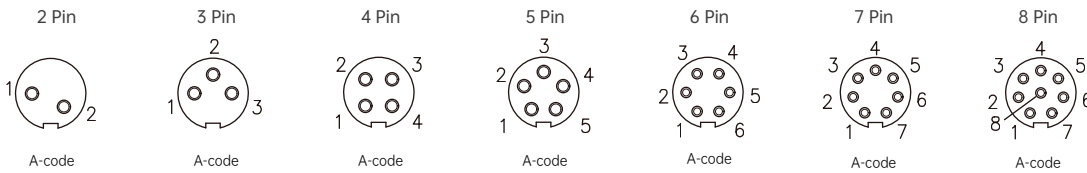

订货信息 / Order daea

| 芯数 / Number of cores | Coding | 料号 / Part number |
|----------------------|--------|------------------|
| 02 Pin               | A-code | M09A02-02-011    |
| 03 Pin               | A-code | M09A03-02-011    |
| 04 Pin               | A-code | M09A04-02-011    |
| 05 Pin               | A-code | M09A05-02-011    |
| 06 Pin               | A-code | M09A06-02-011    |
| 07 Pin               | A-code | M09A07-02-011    |
| 08 Pin               | A-code | M09A08-02-011    |

技术参数 / Specifications

| 芯数 / Pin   | 02 Pin  | 03 Pin              | 04 Pin              | 05 Pin              | 06 Pin              | 07 Pin              | 08 Pin              |
|--|---|---------------------|---------------------|---------------------|---------------------|---------------------|---------------------|
| 额定电流 / Rated current                                 | 4 A   | 4 A                 | 3 A                 | 3 A                 | 1 A                 | 1 A                 | 1 A                 |
| 额定电压 / Rated voltage                                 | A/C (交流) : 125 V D/C (直流) : 125 V                                     |                     |                     |                     |                     |                     |                     |
| 线规 (mm <sup>2</sup> ) / Wire gauge(mm <sup>2</sup> ) | 0.25mm <sup>2</sup>   | 0.25mm <sup>2</sup> | 0.25mm <sup>2</sup> | 0.25mm <sup>2</sup> | 0.14mm <sup>2</sup> | 0.14mm <sup>2</sup> | 0.14mm <sup>2</sup> |
| 线号 (AWG) / Wire gauge(AWG)                           | 24AWG   | 24AWG               | 24AWG               | 24AWG               | 26AWG               | 26AWG               | 26AWG               |
| 壳体材料 / Outer shell material                          | 铜合金 / Copper Alloy  |                     |                     |                     |                     |                     |                     |
| 胶芯材料 / Housing material                              | 尼龙PA66  |                     |                     |                     |                     |                     |                     |
| 成型材料 / Molding material                              | PVC/TPU   |                     |                     |                     |                     |                     |                     |
| 端子材料 / Pin material                                  | 黄铜镀金/磷铜镀金 / Brass With Gold Plated / Phosphor Bronze With Gold Plated |                     |                     |                     |                     |                     |                     |
| 适用温度 / Applicable temperature                        | -40 °C ~ +85 °C   |                     |                     |                     |                     |                     |                     |
| 绝缘电阻 / Insulation resistance                         | ≥ 100MΩ   |                     |                     |                     |                     |                     |                     |
| 接触电阻 / Contact resistance                            | ≤ 3mΩ   |                     |                     |                     |                     |                     |                     |
| 防护等级 / Degree of protection                          | IP67  |                     |                     |                     |                     |                     |                     |
| 插拔次数 / Mechanical durability                         | ≥ 500次  |                     |                     |                     |                     |                     |                     |
| 接线范围 / Wiring range                                  | Φ5mm~Φ8mm   |                     |                     |                     |                     |                     |                     |
| 线材 / Wire rod  | PVC/PUR   |                     |                     |                     |                     |                     |                     |

## M9前锁面板式公头插座 焊线型

产品图 / Product photo



尺寸图 / Dimension

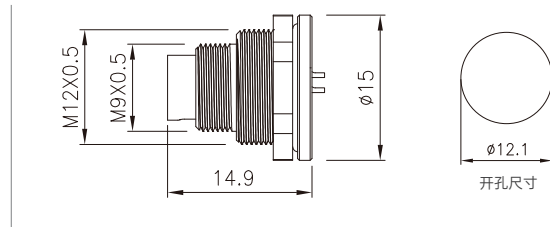

针位分布前视图 / Pin assignment front view

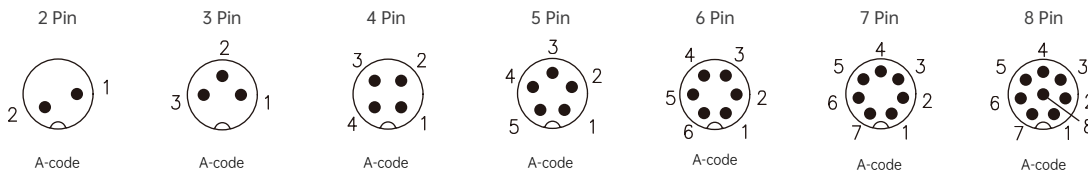

订货信息 / Order daea

| 芯数 / Number of cores | Coding | 料号 / Part number |
|----------------------|--------|------------------|
| 02 Pin               | A-code | M09A02-03-003    |
| 03 Pin               | A-code | M09A03-03-003    |
| 04 Pin               | A-code | M09A04-03-003    |
| 05 Pin               | A-code | M09A05-03-003    |
| 06 Pin               | A-code | M09A06-03-003    |
| 07 Pin               | A-code | M09A07-03-003    |
| 08 Pin               | A-code | M09A08-03-003    |

技术参数 / Specifications

| 芯数 / Pin   | 02 Pin  | 03 Pin              | 04 Pin              | 05 Pin              | 06 Pin              | 07 Pin              | 08 Pin              |
|--|---|---------------------|---------------------|---------------------|---------------------|---------------------|---------------------|
| 额定电流 / Rated current                                 | 4 A   | 4 A                 | 3 A                 | 3 A                 | 1 A                 | 1 A                 | 1 A                 |
| 额定电压 / Rated voltage                                 | A/C (交流) : 125 V D/C (直流) : 125 V                                     |                     |                     |                     |                     |                     |                     |
| 线规 (mm <sup>2</sup> ) / Wire gauge(mm <sup>2</sup> ) | 0.25mm <sup>2</sup>   | 0.25mm <sup>2</sup> | 0.25mm <sup>2</sup> | 0.25mm <sup>2</sup> | 0.14mm <sup>2</sup> | 0.14mm <sup>2</sup> | 0.14mm <sup>2</sup> |
| 线号 (AWG) / Wire gauge(AWG)                           | 24AWG   | 24AWG               | 24AWG               | 24AWG               | 26AWG               | 26AWG               | 26AWG               |
| 壳体材料 / Outer shell material                          | 铜合金 / Copper Alloy  |                     |                     |                     |                     |                     |                     |
| 胶芯材料 / Housing material                              | 尼龙PA66  |                     |                     |                     |                     |                     |                     |
| 成型材料 / Molding material                              | PVC/TPU   |                     |                     |                     |                     |                     |                     |
| 端子材料 / Pin material                                  | 黄铜镀金/磷铜镀金 / Brass With Gold Plated / Phosphor Bronze With Gold Plated |                     |                     |                     |                     |                     |                     |
| 适用温度 / Applicable temperature                        | -40 °C ~ +85 °C   |                     |                     |                     |                     |                     |                     |
| 绝缘电阻 / Insulation resistance                         | ≥ 100MΩ   |                     |                     |                     |                     |                     |                     |
| 接触电阻 / Contact resistance                            | ≤ 3mΩ   |                     |                     |                     |                     |                     |                     |
| 防护等级 / Degree of protection                          | IP67  |                     |                     |                     |                     |                     |                     |
| 插拔次数 / Mechanical durability                         | ≥ 500次  |                     |                     |                     |                     |                     |                     |
| 线材 / Wire rod  | PVC/PUR   |                     |                     |                     |                     |                     |                     |



## M9前锁面板式母头插座 焊线型

产品图 / Product photo



尺寸图 / Dimension

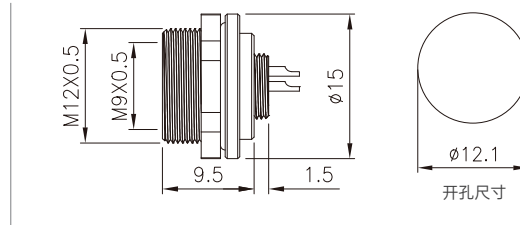

针位分布前视图 / Pin assignment front view

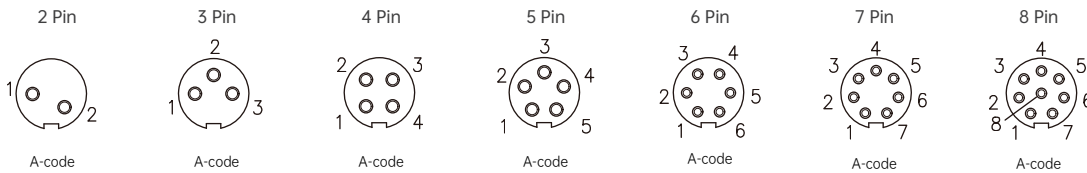

订货信息 / Order daec

| 芯数 / Number of cores | Coding | 料号 / Part number |
|----------------------|--------|------------------|
| 02 Pin               | A-code | M09A02-04-003    |
| 03 Pin               | A-code | M09A03-04-003    |
| 04 Pin               | A-code | M09A03-04-003    |
| 05 Pin               | A-code | M09A05-04-003    |
| 06 Pin               | A-code | M09A06-04-003    |
| 07 Pin               | A-code | M09A07-04-003    |
| 08 Pin               | A-code | M09A08-04-003    |

技术参数 / Specifications

| 芯数 / Pin   | 02 Pin  | 03 Pin              | 04 Pin              | 05 Pin              | 06 Pin              | 07 Pin              | 08 Pin              |
|--|---|---------------------|---------------------|---------------------|---------------------|---------------------|---------------------|
| 额定电流 / Rated current                                 | 4 A   | 4 A                 | 3 A                 | 3 A                 | 1 A                 | 1 A                 | 1 A                 |
| 额定电压 / Rated voltage                                 | A/C (交流) : 125 V D/C (直流) : 125 V                                     |                     |                     |                     |                     |                     |                     |
| 线规 (mm <sup>2</sup> ) / Wire gauge(mm <sup>2</sup> ) | 0.25mm <sup>2</sup>   | 0.25mm <sup>2</sup> | 0.25mm <sup>2</sup> | 0.25mm <sup>2</sup> | 0.14mm <sup>2</sup> | 0.14mm <sup>2</sup> | 0.14mm <sup>2</sup> |
| 线号 (AWG) / Wire gauge(AWG)                           | 24AWG   | 24AWG               | 24AWG               | 24AWG               | 26AWG               | 26AWG               | 26AWG               |
| 壳体材料 / Outer shell material                          | 铜合金 / Copper Alloy  |                     |                     |                     |                     |                     |                     |
| 胶芯材料 / Housing material                              | 尼龙PA66  |                     |                     |                     |                     |                     |                     |
| 成型材料 / Molding material                              | PVC/TPU   |                     |                     |                     |                     |                     |                     |
| 端子材料 / Pin material                                  | 黄铜镀金/磷铜镀金 / Brass With Gold Plated / Phosphor Bronze With Gold Plated |                     |                     |                     |                     |                     |                     |
| 适用温度 / Applicable temperature                        | -40 °C ~ +85 °C   |                     |                     |                     |                     |                     |                     |
| 绝缘电阻 / Insulation resistance                         | ≥ 100MΩ   |                     |                     |                     |                     |                     |                     |
| 接触电阻 / Contact resistance                            | ≤ 3mΩ   |                     |                     |                     |                     |                     |                     |
| 防护等级 / Degree of protection                          | IP67  |                     |                     |                     |                     |                     |                     |
| 插拔次数 / Mechanical durability                         | ≥ 500次  |                     |                     |                     |                     |                     |                     |
| 线材 / Wire rod  | PVC/PUR   |                     |                     |                     |                     |                     |                     |

## M9前锁面板式公头插座 焊板型

产品图 / Product photo



尺寸图 / Dimension

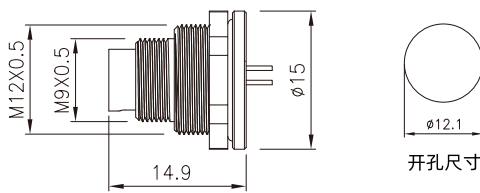

| 2 Pin                     | 3 Pin  | 4 Pin  | 5 Pin  | 6 Pin  | 7 Pin  | 8 Pin  |
|---------------------------|--------|--------|--------|--------|--------|--------|
|                           |        |        |        |        |        |        |
| A-code                    | A-code | A-code | A-code | A-code | A-code | A-code |
| PCB芯位图 / PCB core diagram |        |        |        |        |        |        |
|                           |        |        |        |        |        |        |

订货信息 / Order daec

| 芯数 / Number of cores | Coding | 料号 / Part number |
|----------------------|--------|------------------|
| 02 Pin               | A-code | M09A02-03-004    |
| 03 Pin               | A-code | M09A03-03-004    |
| 04 Pin               | A-code | M09A04-03-004    |
| 05 Pin               | A-code | M09A05-03-004    |
| 06 Pin               | A-code | M09A06-03-004    |
| 07 Pin               | A-code | M09A07-03-004    |
| 08 Pin               | A-code | M09A08-03-004    |

技术参数 / Specifications

| 芯数 / Pin   | 02 Pin  | 03 Pin              | 04 Pin              | 05 Pin              | 06 Pin              | 07 Pin              | 08 Pin              |
|--|---|---------------------|---------------------|---------------------|---------------------|---------------------|---------------------|
| 额定电流 / Rated current                                 | 4 A   | 4 A                 | 3 A                 | 3 A                 | 1 A                 | 1 A                 | 1 A                 |
| 额定电压 / Rated voltage                                 | A/C (交流) : 125 V D/C (直流) : 125 V                                     |                     |                     |                     |                     |                     |                     |
| 线规 (mm <sup>2</sup> ) / Wire gauge(mm <sup>2</sup> ) | 0.25mm <sup>2</sup>   | 0.25mm <sup>2</sup> | 0.25mm <sup>2</sup> | 0.25mm <sup>2</sup> | 0.14mm <sup>2</sup> | 0.14mm <sup>2</sup> | 0.14mm <sup>2</sup> |
| 线号 (AWG) / Wire gauge(AWG)                           | 24AWG   | 24AWG               | 24AWG               | 24AWG               | 26AWG               | 26AWG               | 26AWG               |
| 壳体材料 / Outer shell material                          | 铜合金 / Copper Alloy  |                     |                     |                     |                     |                     |                     |
| 胶芯材料 / Housing material                              | 尼龙PA66  |                     |                     |                     |                     |                     |                     |
| 成型材料 / Molding material                              | PVC/TPU   |                     |                     |                     |                     |                     |                     |
| 端子材料 / Pin material                                  | 黄铜镀金/磷铜镀金 / Brass With Gold Plated / Phosphor Bronze With Gold Plated |                     |                     |                     |                     |                     |                     |
| 适用温度 / Applicable temperature                        | -40 °C ~ +85 °C   |                     |                     |                     |                     |                     |                     |
| 绝缘电阻 / Insulation resistance                         | ≥ 100MΩ   |                     |                     |                     |                     |                     |                     |
| 接触电阻 / Contact resistance                            | ≤ 3mΩ   |                     |                     |                     |                     |                     |                     |
| 防护等级 / Degree of protection                          | IP67  |                     |                     |                     |                     |                     |                     |
| 插拔次数 / Mechanical durability                         | ≥ 500次  |                     |                     |                     |                     |                     |                     |
| 线材 / Wire rod  | PVC/PUR   |                     |                     |                     |                     |                     |                     |

## M9前锁面板式母头插座 焊板型

产品图 / Product photo



尺寸图 / Dimension

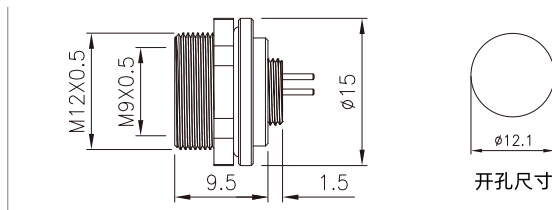

开孔尺寸

| 2 Pin                     | 3 Pin  | 4 Pin  | 5 Pin  | 6 Pin  | 7 Pin  | 8 Pin  |
|---------------------------|--------|--------|--------|--------|--------|--------|
|                           |        |        |        |        |        |        |
| A-code                    | A-code | A-code | A-code | A-code | A-code | A-code |
| PCB芯位图 / PCB core diagram |        |        |        |        |        |        |
|                           |        |        |        |        |        |        |

订货信息 / Order daea

| 芯数 / Number of cores | Coding | 料号 / Part number |
|----------------------|--------|------------------|
| 02 Pin               | A-code | M09A02-04-004    |
| 03 Pin               | A-code | M09A03-04-004    |
| 04 Pin               | A-code | M09A04-04-004    |
| 05 Pin               | A-code | M09A05-04-004    |
| 06 Pin               | A-code | M09A06-04-004    |
| 07 Pin               | A-code | M09A07-04-004    |
| 08 Pin               | A-code | M09A08-04-004    |

技术参数 / Specifications

| 芯数 / Pin   | 02 Pin  | 03 Pin              | 04 Pin              | 05 Pin              | 06 Pin              | 07 Pin              | 08 Pin              |
|--|---|---------------------|---------------------|---------------------|---------------------|---------------------|---------------------|
| 额定电流 / Rated current                                 | 4 A   | 4 A                 | 3 A                 | 3 A                 | 1 A                 | 1 A                 | 1 A                 |
| 额定电压 / Rated voltage                                 | A/C (交流) : 125 V D/C (直流) : 125 V                                     |                     |                     |                     |                     |                     |                     |
| 线规 (mm <sup>2</sup> ) / Wire gauge(mm <sup>2</sup> ) | 0.25mm <sup>2</sup>   | 0.25mm <sup>2</sup> | 0.25mm <sup>2</sup> | 0.25mm <sup>2</sup> | 0.14mm <sup>2</sup> | 0.14mm <sup>2</sup> | 0.14mm <sup>2</sup> |
| 线号 (AWG) / Wire gauge(AWG)                           | 24AWG   | 24AWG               | 24AWG               | 24AWG               | 26AWG               | 26AWG               | 26AWG               |
| 壳体材料 / Outer shell material                          | 铜合金 / Copper Alloy  |                     |                     |                     |                     |                     |                     |
| 胶芯材料 / Housing material                              | 尼龙PA66  |                     |                     |                     |                     |                     |                     |
| 成型材料 / Molding material                              | PVC/TPU   |                     |                     |                     |                     |                     |                     |
| 端子材料 / Pin material                                  | 黄铜镀金/磷铜镀金 / Brass With Gold Plated / Phosphor Bronze With Gold Plated |                     |                     |                     |                     |                     |                     |
| 适用温度 / Applicable temperature                        | -40 °C ~ +85 °C   |                     |                     |                     |                     |                     |                     |
| 绝缘电阻 / Insulation resistance                         | ≥ 100MΩ   |                     |                     |                     |                     |                     |                     |
| 接触电阻 / Contact resistance                            | ≤ 3mΩ   |                     |                     |                     |                     |                     |                     |
| 防护等级 / Degree of protection                          | IP67  |                     |                     |                     |                     |                     |                     |
| 插拔次数 / Mechanical durability                         | ≥ 500次  |                     |                     |                     |                     |                     |                     |
| 线材 / Wire rod  | PVC/PUR   |                     |                     |                     |                     |                     |                     |

## M9后锁面板式公头插座 焊线型

产品图 / Product photo



尺寸图 / Dimension

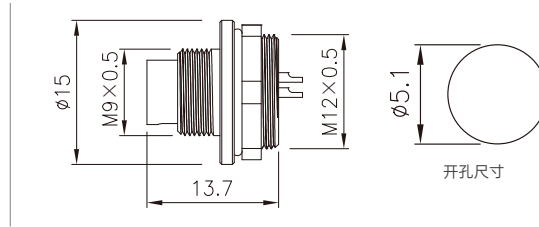

针位分布前视图 / Pin assignment front view

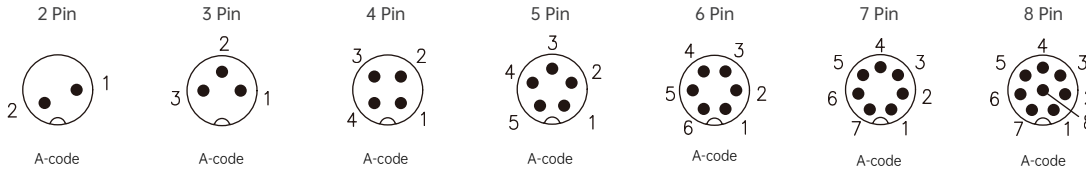

订货信息 / Order daec

| 芯数 / Number of cores | Coding | 料号 / Part number |
|----------------------|--------|------------------|
| 02 Pin               | A-code | M09A02-03-001    |
| 03 Pin               | A-code | M09A03-03-001    |
| 04 Pin               | A-code | M09A04-03-001    |
| 05 Pin               | A-code | M09A05-03-001    |
| 06 Pin               | A-code | M09A06-03-001    |
| 07 Pin               | A-code | M09A07-03-001    |
| 08 Pin               | A-code | M09A08-03-001    |

技术参数 / Specifications

| 芯数 / Pin   | 02 Pin  | 03 Pin              | 04 Pin              | 05 Pin              | 06 Pin              | 07 Pin              | 08 Pin              |
|--|---|---------------------|---------------------|---------------------|---------------------|---------------------|---------------------|
| 额定电流 / Rated current                                 | 4 A   | 4 A                 | 3 A                 | 3 A                 | 1 A                 | 1 A                 | 1 A                 |
| 额定电压 / Rated voltage                                 | A/C (交流) : 125 V D/C (直流) : 125 V                                     |                     |                     |                     |                     |                     |                     |
| 线规 (mm <sup>2</sup> ) / Wire gauge(mm <sup>2</sup> ) | 0.25mm <sup>2</sup>   | 0.25mm <sup>2</sup> | 0.25mm <sup>2</sup> | 0.25mm <sup>2</sup> | 0.14mm <sup>2</sup> | 0.14mm <sup>2</sup> | 0.14mm <sup>2</sup> |
| 线号 (AWG) / Wire gauge(AWG)                           | 24AWG   | 24AWG               | 24AWG               | 24AWG               | 26AWG               | 26AWG               | 26AWG               |
| 壳体材料 / Outer shell material                          | 铜合金 / Copper Alloy  |                     |                     |                     |                     |                     |                     |
| 胶芯材料 / Housing material                              | 尼龙PA66  |                     |                     |                     |                     |                     |                     |
| 成型材料 / Molding material                              | PVC/TPU   |                     |                     |                     |                     |                     |                     |
| 端子材料 / Pin material                                  | 黄铜镀金/磷铜镀金 / Brass With Gold Plated / Phosphor Bronze With Gold Plated |                     |                     |                     |                     |                     |                     |
| 适用温度 / Applicable temperature                        | -40 °C ~ +85 °C   |                     |                     |                     |                     |                     |                     |
| 绝缘电阻 / Insulation resistance                         | ≥ 100MΩ   |                     |                     |                     |                     |                     |                     |
| 接触电阻 / Contact resistance                            | ≤ 3mΩ   |                     |                     |                     |                     |                     |                     |
| 防护等级 / Degree of protection                          | IP67  |                     |                     |                     |                     |                     |                     |
| 插拔次数 / Mechanical durability                         | ≥ 500次  |                     |                     |                     |                     |                     |                     |
| 线材 / Wire rod  | PVC/PUR   |                     |                     |                     |                     |                     |                     |

## M9后锁面板式母头插座 焊线型

产品图 / Product photo



尺寸图 / Dimension

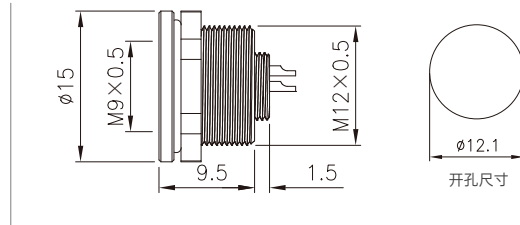

针位分布前视图 / Pin assignment front view

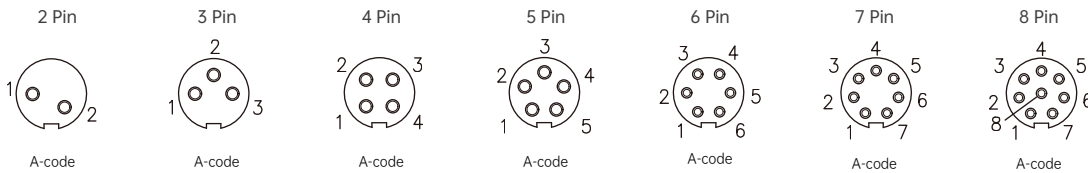

订货信息 / Order daec

| 芯数 / Number of cores | Coding | 料号 / Part number |
|----------------------|--------|------------------|
| 02 Pin               | A-code | M09A02-04-001    |
| 03 Pin               | A-code | M09A03-04-001    |
| 04 Pin               | A-code | M09A04-04-001    |
| 05 Pin               | A-code | M09A05-04-001    |
| 06 Pin               | A-code | M09A06-04-001    |
| 07 Pin               | A-code | M09A07-04-001    |
| 08 Pin               | A-code | M09A08-04-001    |

技术参数 / Specifications

| 芯数 / Pin   | 02 Pin  | 03 Pin              | 04 Pin              | 05 Pin              | 06 Pin              | 07 Pin              | 08 Pin              |
|--|---|---------------------|---------------------|---------------------|---------------------|---------------------|---------------------|
| 额定电流 / Rated current                                 | 4 A   | 4 A                 | 3 A                 | 3 A                 | 1 A                 | 1 A                 | 1 A                 |
| 额定电压 / Rated voltage                                 | A/C (交流) : 125 V D/C (直流) : 125 V                                     |                     |                     |                     |                     |                     |                     |
| 线规 (mm <sup>2</sup> ) / Wire gauge(mm <sup>2</sup> ) | 0.25mm <sup>2</sup>   | 0.25mm <sup>2</sup> | 0.25mm <sup>2</sup> | 0.25mm <sup>2</sup> | 0.14mm <sup>2</sup> | 0.14mm <sup>2</sup> | 0.14mm <sup>2</sup> |
| 线号 (AWG) / Wire gauge(AWG)                           | 24AWG   | 24AWG               | 24AWG               | 24AWG               | 26AWG               | 26AWG               | 26AWG               |
| 壳体材料 / Outer shell material                          | 铜合金 / Copper Alloy  |                     |                     |                     |                     |                     |                     |
| 胶芯材料 / Housing material                              | 尼龙PA66  |                     |                     |                     |                     |                     |                     |
| 成型材料 / Molding material                              | PVC/TPU   |                     |                     |                     |                     |                     |                     |
| 端子材料 / Pin material                                  | 黄铜镀金/磷铜镀金 / Brass With Gold Plated / Phosphor Bronze With Gold Plated |                     |                     |                     |                     |                     |                     |
| 适用温度 / Applicable temperature                        | -40 °C ~ +85 °C   |                     |                     |                     |                     |                     |                     |
| 绝缘电阻 / Insulation resistance                         | ≥ 100MΩ   |                     |                     |                     |                     |                     |                     |
| 接触电阻 / Contact resistance                            | ≤ 3mΩ   |                     |                     |                     |                     |                     |                     |
| 防护等级 / Degree of protection                          | IP67  |                     |                     |                     |                     |                     |                     |
| 插拔次数 / Mechanical durability                         | ≥ 500次  |                     |                     |                     |                     |                     |                     |
| 线材 / Wire rod  | PVC/PUR   |                     |                     |                     |                     |                     |                     |

## M9公直头成型式线束 屏蔽/非屏蔽 线长L可定制

产品图 / Product photo



尺寸图 / Dimension

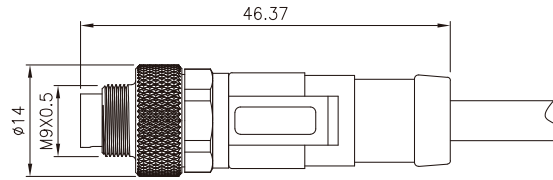

针位分布前视图 / Pin assignment front view

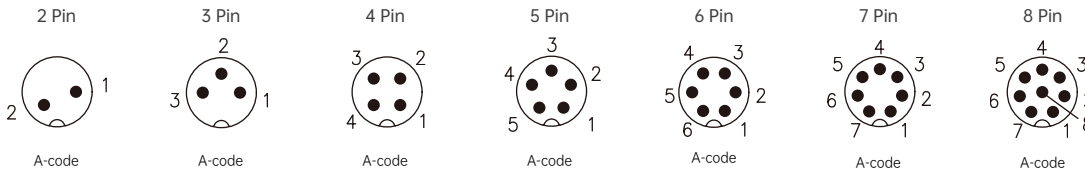

订货信息 / Order daea

| 芯数 / Contacts | 编码 / Code | 产品料号("L"表示长度, 单位毫米mm) / Part number ("L" is length millimetre mm) |                   |                   |                   |
|---------------|-----------|---|-------------------|-------------------|-------------------|
|               |           | 1: PVC 无屏蔽  | 2: PUR 无屏蔽        | 3: PVC 带屏蔽        | 4: PUR 带屏蔽        |
| 02 Pin        | A-code    | M09A02-07-010-1-L   | M09A02-07-010-2-L | M09A02-07-010-3-L | M09A02-07-010-4-L |
| 03 Pin        | A-code    | M09A03-07-010-1-L   | M09A03-07-010-2-L | M09A03-07-010-3-L | M09A03-07-010-4-L |
| 04 Pin        | A-code    | M09A04-07-010-1-L   | M09A04-07-010-2-L | M09A04-07-010-3-L | M09A04-07-010-4-L |
| 05 Pin        | A-code    | M09A05-07-010-1-L   | M09A05-07-010-2-L | M09A05-07-010-3-L | M09A05-07-010-4-L |
| 06 Pin        | A-code    | M09A06-07-010-1-L   | M09A06-07-010-2-L | M09A06-07-010-3-L | M09A06-07-010-4-L |
| 07 Pin        | A-code    | M09A07-07-010-1-L   | M09A07-07-010-2-L | M09A07-07-010-3-L | M09A07-07-010-4-L |
| 08 Pin        | A-code    | M09A08-07-010-1-L   | M09A08-07-010-2-L | M09A08-07-010-3-L | M09A08-07-010-4-L |

技术参数 / Specifications

| 芯数 / Pin   | 02 Pin  | 03 Pin              | 04 Pin              | 05 Pin              | 06 Pin              | 07 Pin              | 08 Pin              |
|--|---|---------------------|---------------------|---------------------|---------------------|---------------------|---------------------|
| 额定电流 / Rated current                                 | 4 A   | 4 A                 | 3 A                 | 3 A                 | 1 A                 | 1 A                 | 1 A                 |
| 额定电压 / Rated voltage                                 | A/C (交流) : 125 V D/C (直流) : 125 V                                     |                     |                     |                     |                     |                     |                     |
| 线规 (mm <sup>2</sup> ) / Wire gauge(mm <sup>2</sup> ) | 0.25mm <sup>2</sup>   | 0.25mm <sup>2</sup> | 0.25mm <sup>2</sup> | 0.25mm <sup>2</sup> | 0.14mm <sup>2</sup> | 0.14mm <sup>2</sup> | 0.14mm <sup>2</sup> |
| 线号 (AWG) / Wire gauge(AWG)                           | 24AWG   | 24AWG               | 24AWG               | 24AWG               | 26AWG               | 26AWG               | 26AWG               |
| 壳体材料 / Outer shell material                          | 铜合金 / Copper Alloy  |                     |                     |                     |                     |                     |                     |
| 胶芯材料 / Housing material                              | 尼龙PA66  |                     |                     |                     |                     |                     |                     |
| 成型材料 / Molding material                              | PVC/TPU   |                     |                     |                     |                     |                     |                     |
| 端子材料 / Pin material                                  | 黄铜镀金/磷铜镀金 / Brass With Gold Plated / Phosphor Bronze With Gold Plated |                     |                     |                     |                     |                     |                     |
| 适用温度 / Applicable temperature                        | -40 °C ~ +85 °C   |                     |                     |                     |                     |                     |                     |
| 绝缘电阻 / Insulation resistance                         | ≥ 100MΩ   |                     |                     |                     |                     |                     |                     |
| 接触电阻 / Contact resistance                            | ≤ 3mΩ   |                     |                     |                     |                     |                     |                     |
| 防护等级 / Degree of protection                          | IP67  |                     |                     |                     |                     |                     |                     |
| 插拔次数 / Mechanical durability                         | ≥ 500次  |                     |                     |                     |                     |                     |                     |
| 线材 / Wire rod  | PVC/PUR   |                     |                     |                     |                     |                     |                     |

## M9母直头成型式线束 屏蔽/非屏蔽 线长L可定制

产品图 / Product photo



尺寸图 / Dimension

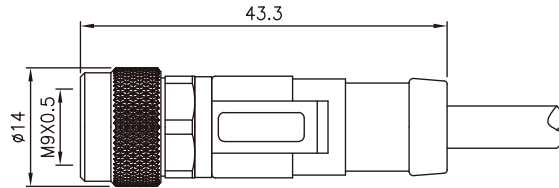

针位分布前视图 / Pin assignment front view

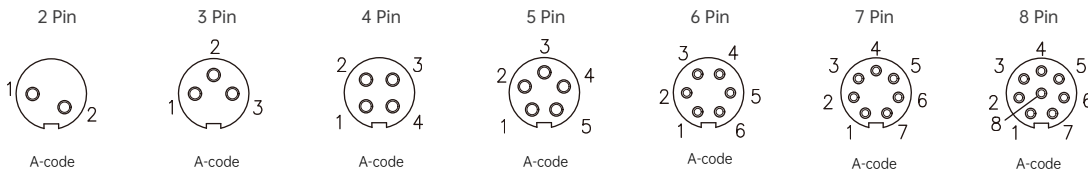

订货信息 / Order daea

| 芯数 / Contacts | 编码 / Code | 产品料号("L"表示长度, 单位毫米mm) / Part number ("L" is length millimetre mm) |                   |                   |                   |
|---------------|-----------|---|-------------------|-------------------|-------------------|
|               |           | 1: PVC 无屏蔽  | 2: PUR 无屏蔽        | 3: PVC 带屏蔽        | 4: PUR 带屏蔽        |
| 02 Pin        | A-code    | M09A02-08-010-1-L   | M09A02-08-010-2-L | M09A02-08-010-3-L | M09A02-08-010-4-L |
| 03 Pin        | A-code    | M09A03-08-010-1-L   | M09A03-08-010-2-L | M09A03-08-010-3-L | M09A03-08-010-4-L |
| 04 Pin        | A-code    | M09A04-08-010-1-L   | M09A04-08-010-2-L | M09A04-08-010-3-L | M09A04-08-010-4-L |
| 05 Pin        | A-code    | M09A05-08-010-1-L   | M09A05-08-010-2-L | M09A05-08-010-3-L | M09A05-08-010-4-L |
| 06 Pin        | A-code    | M09A06-08-010-1-L   | M09A06-08-010-2-L | M09A06-08-010-3-L | M09A06-08-010-4-L |
| 07 Pin        | A-code    | M09A07-08-010-1-L   | M09A07-08-010-2-L | M09A07-08-010-3-L | M09A07-08-010-4-L |
| 08 Pin        | A-code    | M09A08-08-010-1-L   | M09A08-08-010-2-L | M09A08-08-010-3-L | M09A08-08-010-4-L |

技术参数 / Specifications

| 芯数 / Pin   | 02 Pin  | 03 Pin              | 04 Pin              | 05 Pin              | 06 Pin              | 07 Pin              | 08 Pin              |
|--|---|---------------------|---------------------|---------------------|---------------------|---------------------|---------------------|
| 额定电流 / Rated current                                 | 4 A   | 4 A                 | 3 A                 | 3 A                 | 1 A                 | 1 A                 | 1 A                 |
| 额定电压 / Rated voltage                                 | A/C (交流) : 125 V D/C (直流) : 125 V                                     |                     |                     |                     |                     |                     |                     |
| 线规 (mm <sup>2</sup> ) / Wire gauge(mm <sup>2</sup> ) | 0.25mm <sup>2</sup>   | 0.25mm <sup>2</sup> | 0.25mm <sup>2</sup> | 0.25mm <sup>2</sup> | 0.14mm <sup>2</sup> | 0.14mm <sup>2</sup> | 0.14mm <sup>2</sup> |
| 线号 (AWG) / Wire gauge(AWG)                           | 24AWG   | 24AWG               | 24AWG               | 24AWG               | 26AWG               | 26AWG               | 26AWG               |
| 壳体材料 / Outer shell material                          | 铜合金 / Copper Alloy  |                     |                     |                     |                     |                     |                     |
| 胶芯材料 / Housing material                              | 尼龙PA66  |                     |                     |                     |                     |                     |                     |
| 成型材料 / Molding material                              | PVC/TPU   |                     |                     |                     |                     |                     |                     |
| 端子材料 / Pin material                                  | 黄铜镀金/磷铜镀金 / Brass With Gold Plated / Phosphor Bronze With Gold Plated |                     |                     |                     |                     |                     |                     |
| 适用温度 / Applicable temperature                        | -40 °C ~ +85 °C   |                     |                     |                     |                     |                     |                     |
| 绝缘电阻 / Insulation resistance                         | ≥ 100MΩ   |                     |                     |                     |                     |                     |                     |
| 接触电阻 / Contact resistance                            | ≤ 3mΩ   |                     |                     |                     |                     |                     |                     |
| 防护等级 / Degree of protection                          | IP67  |                     |                     |                     |                     |                     |                     |
| 插拔次数 / Mechanical durability                         | ≥ 500次  |                     |                     |                     |                     |                     |                     |
| 线材 / Wire rod  | PVC/PUR   |                     |                     |                     |                     |                     |                     |

## M9公直头成型式线束 屏蔽/非屏蔽 线长L可定制

产品图 / Product photo



尺寸图 / Dimension

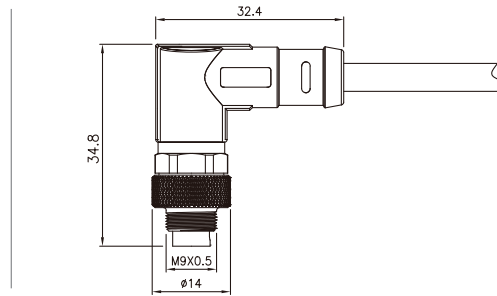

针位分布前视图 / Pin assignment front view

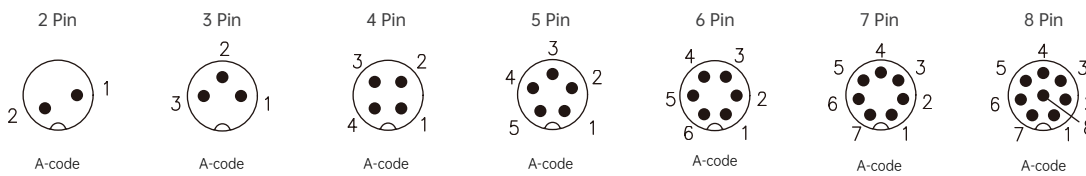

订货信息 / Order daea

| 芯数 / Contacts | 编码 / Code | 产品料号("L"表示长度, 单位毫米mm) / Part number ("L" is length millimetre mm) |                   |                   |                   |
|---------------|-----------|---|-------------------|-------------------|-------------------|
|               |           | 1: PVC 无屏蔽  | 2: PUR 无屏蔽        | 3: PVC 带屏蔽        | 4: PUR 带屏蔽        |
| 02 Pin        | A-code    | M09A02-07-011-1-L   | M09A02-07-011-2-L | M09A02-07-011-3-L | M09A02-07-011-4-L |
| 03 Pin        | A-code    | M09A03-07-011-1-L   | M09A03-07-011-2-L | M09A03-07-011-3-L | M09A03-07-011-4-L |
| 04 Pin        | A-code    | M09A04-07-011-1-L   | M09A04-07-011-2-L | M09A04-07-011-3-L | M09A04-07-011-4-L |
| 05 Pin        | A-code    | M09A05-07-011-1-L   | M09A05-07-011-2-L | M09A05-07-011-3-L | M09A05-07-011-4-L |
| 06 Pin        | A-code    | M09A06-07-011-1-L   | M09A06-07-011-2-L | M09A06-07-011-3-L | M09A06-07-011-4-L |
| 07 Pin        | A-code    | M09A07-07-011-1-L   | M09A07-07-011-2-L | M09A07-07-011-3-L | M09A07-07-011-4-L |
| 08 Pin        | A-code    | M09A08-07-011-1-L   | M09A08-07-011-2-L | M09A08-07-011-3-L | M09A08-07-011-4-L |

技术参数 / Specifications

| 芯数 / Pin   | 02 Pin  | 03 Pin              | 04 Pin              | 05 Pin              | 06 Pin              | 07 Pin              | 08 Pin              |
|--|---|---------------------|---------------------|---------------------|---------------------|---------------------|---------------------|
| 额定电流 / Rated current                                 | 4 A   | 4 A                 | 3 A                 | 3 A                 | 1 A                 | 1 A                 | 1 A                 |
| 额定电压 / Rated voltage                                 | A/C (交流) : 125 V D/C (直流) : 125 V                                     |                     |                     |                     |                     |                     |                     |
| 线规 (mm <sup>2</sup> ) / Wire gauge(mm <sup>2</sup> ) | 0.25mm <sup>2</sup>   | 0.25mm <sup>2</sup> | 0.25mm <sup>2</sup> | 0.25mm <sup>2</sup> | 0.14mm <sup>2</sup> | 0.14mm <sup>2</sup> | 0.14mm <sup>2</sup> |
| 线号 (AWG) / Wire gauge(AWG)                           | 24AWG   | 24AWG               | 24AWG               | 24AWG               | 26AWG               | 26AWG               | 26AWG               |
| 壳体材料 / Outer shell material                          | 铜合金 / Copper Alloy  |                     |                     |                     |                     |                     |                     |
| 胶芯材料 / Housing material                              | 尼龙PA66  |                     |                     |                     |                     |                     |                     |
| 成型材料 / Molding material                              | PVC/TPU   |                     |                     |                     |                     |                     |                     |
| 端子材料 / Pin material                                  | 黄铜镀金/磷铜镀金 / Brass With Gold Plated / Phosphor Bronze With Gold Plated |                     |                     |                     |                     |                     |                     |
| 适用温度 / Applicable temperature                        | -40 °C ~ +85 °C   |                     |                     |                     |                     |                     |                     |
| 绝缘电阻 / Insulation resistance                         | ≥ 100MΩ   |                     |                     |                     |                     |                     |                     |
| 接触电阻 / Contact resistance                            | ≤ 3mΩ   |                     |                     |                     |                     |                     |                     |
| 防护等级 / Degree of protection                          | IP67  |                     |                     |                     |                     |                     |                     |
| 插拔次数 / Mechanical durability                         | ≥ 500次  |                     |                     |                     |                     |                     |                     |
| 线材 / Wire rod  | PVC/PUR   |                     |                     |                     |                     |                     |                     |



## M9母弯头成型式线束 屏蔽/非屏蔽 线长L可定制

产品图 / Product photo



尺寸图 / Dimension

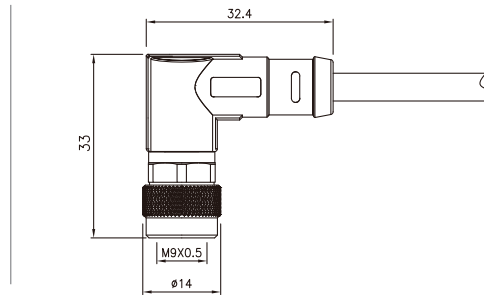

针位分布前视图 / Pin assignment front view

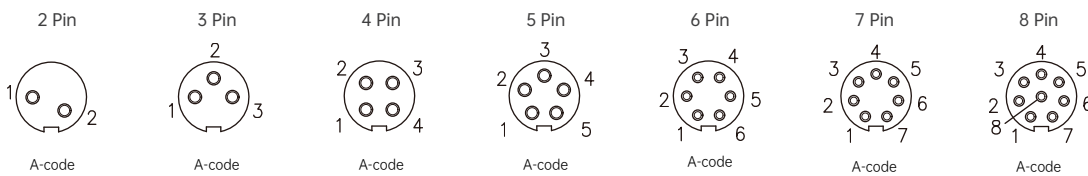

订货信息 / Order daea

| 芯数 / Contacts | 编码 / Code | 产品料号("L"表示长度, 单位毫米mm) / Part number ("L" is length millimetre mm) |                   |                   |                   |
|---------------|-----------|---|-------------------|-------------------|-------------------|
|               |           | 1: PVC 无屏蔽  | 2: PUR 无屏蔽        | 3: PVC 带屏蔽        | 4: PUR 带屏蔽        |
| 02 Pin        | A-code    | M09A02-08-011-1-L   | M09A02-08-011-2-L | M09A02-08-011-3-L | M09A02-08-011-4-L |
| 03 Pin        | A-code    | M09A03-08-011-1-L   | M09A03-08-011-2-L | M09A03-08-011-3-L | M09A03-08-011-4-L |
| 04 Pin        | A-code    | M09A04-08-011-1-L   | M09A04-08-011-2-L | M09A04-08-011-3-L | M09A04-08-011-4-L |
| 05 Pin        | A-code    | M09A05-08-011-1-L   | M09A05-08-011-2-L | M09A05-08-011-3-L | M09A05-08-011-4-L |
| 06 Pin        | A-code    | M09A06-08-011-1-L   | M09A06-08-011-2-L | M09A06-08-011-3-L | M09A06-08-011-4-L |
| 07 Pin        | A-code    | M09A07-08-011-1-L   | M09A07-08-011-2-L | M09A07-08-011-3-L | M09A07-08-011-4-L |
| 08 Pin        | A-code    | M09A08-08-011-1-L   | M09A08-08-011-2-L | M09A08-08-011-3-L | M09A08-08-011-4-L |

技术参数 / Specifications

| 芯数 / Pin   | 02 Pin  | 03 Pin              | 04 Pin              | 05 Pin              | 06 Pin              | 07 Pin              | 08 Pin              |
|--|---|---------------------|---------------------|---------------------|---------------------|---------------------|---------------------|
| 额定电流 / Rated current                                 | 4 A   | 4 A                 | 3 A                 | 3 A                 | 1 A                 | 1 A                 | 1 A                 |
| 额定电压 / Rated voltage                                 | A/C (交流) : 125 V D/C (直流) : 125 V                                     |                     |                     |                     |                     |                     |                     |
| 线规 (mm <sup>2</sup> ) / Wire gauge(mm <sup>2</sup> ) | 0.25mm <sup>2</sup>   | 0.25mm <sup>2</sup> | 0.25mm <sup>2</sup> | 0.25mm <sup>2</sup> | 0.14mm <sup>2</sup> | 0.14mm <sup>2</sup> | 0.14mm <sup>2</sup> |
| 线号 (AWG) / Wire gauge(AWG)                           | 24AWG   | 24AWG               | 24AWG               | 24AWG               | 26AWG               | 26AWG               | 26AWG               |
| 壳体材料 / Outer shell material                          | 铜合金 / Copper Alloy  |                     |                     |                     |                     |                     |                     |
| 胶芯材料 / Housing material                              | 尼龙PA66  |                     |                     |                     |                     |                     |                     |
| 成型材料 / Molding material                              | PVC/TPU   |                     |                     |                     |                     |                     |                     |
| 端子材料 / Pin material                                  | 黄铜镀金/磷铜镀金 / Brass With Gold Plated / Phosphor Bronze With Gold Plated |                     |                     |                     |                     |                     |                     |
| 适用温度 / Applicable temperature                        | -40 °C ~ +85 °C   |                     |                     |                     |                     |                     |                     |
| 绝缘电阻 / Insulation resistance                         | ≥ 100MΩ   |                     |                     |                     |                     |                     |                     |
| 接触电阻 / Contact resistance                            | ≤ 3mΩ   |                     |                     |                     |                     |                     |                     |
| 防护等级 / Degree of protection                          | IP67  |                     |                     |                     |                     |                     |                     |
| 插拔次数 / Mechanical durability                         | ≥ 500次  |                     |                     |                     |                     |                     |                     |
| 线材 / Wire rod  | PVC/PUR   |                     |                     |                     |                     |                     |                     |

## M12公直头金属款组装式插头 螺钉压接 屏蔽

产品图 / Product photo



尺寸图 / Dimension

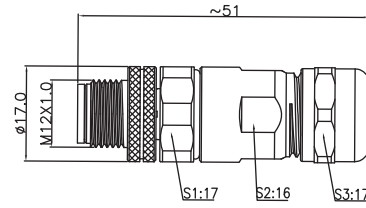

针位分布前视图 / Pin assignment front view

|        | 2 Pin | 3 Pin | 4 Pin | 5 Pin | 6 Pin | 7 Pin | 8 Pin |
|--------|-------|-------|-------|-------|-------|-------|-------|
| A-code |       |       |       |       |       |       |       |
| B-code |       |       |       |       |       |       |       |
| D-code |       |       |       |       |       |       |       |

订货信息 / Order daea

| 芯数 / Number of cores | Coding | 料号 / Part number | Qty      |
|----------------------|--------|------------------|----------|
| 02 Pin               | A-code | M12A02-01-012    | 1000 pcs |
| 03 Pin               | A-code | M12A03-01-012    | 1000 pcs |
| 04 Pin               | A-code | M12A04-01-012    | 1000 pcs |
| 05 Pin               | A-code | M12A05-01-012    | 1000 pcs |
| 06 Pin               | A-code | M12A06-01-012    | 1000 pcs |
| 07 Pin               | A-code | M12A07-01-012    | 1000 pcs |
| 08 Pin               | A-code | M12A08-01-012    | 1000 pcs |
| 04 Pin               | B-code | M12B04-01-012    | 1000 pcs |
| 05 Pin               | B-code | M12B05-01-012    | 1000 pcs |
| 04 Pin               | D-code | M12D04-01-012    | 1000 pcs |

技术参数 / Specifications

| 芯数 / Pin                      | 02 Pin                          | 03 Pin | 04 Pin | 05 Pin | 06 Pin | 07 Pin | 08 Pin |
|-------------------------------|---------------------------------|--------|--------|--------|--------|--------|--------|
| 额定电流 / Rated current          | 4 A                             | 4 A    | 4 A    | 4 A    | 2 A    | 2 A    | 2 A    |
| 额定电压 / Rated voltage          | 250 V                           | 250 V  | 250 V  | 60 V   | 30 V   | 30 V   | 30 V   |
| 标准 / Standard                 | IEC 61076-2-101                 |        |        |        |        |        |        |
| 接线方式 / Termination            | 螺钉压接 / Screw Crimping           |        |        |        |        |        |        |
| 锁紧方式 / Connect locking system | 螺纹锁紧 / Screw Lock               |        |        |        |        |        |        |
| 防护等级 / Degree of protection   | IP66                            |        |        |        |        |        |        |
| 插拔次数 / Mechanical durability  | 500次                            |        |        |        |        |        |        |
| 工作温度 / Operation temperature  | -25 °C ~ +85 °C                 |        |        |        |        |        |        |
| 接触电阻 / Contact resistance     | ≤ 10mΩ                          |        |        |        |        |        |        |
| 绝缘电阻 / Insulation resistance  | ≥ 1000MΩ                        |        |        |        |        |        |        |
| 胶芯材料 / Housing material       | 尼龙PA66                          |        |        |        |        |        |        |
| 端子材料 / Pin material           | 黄铜镀金 / Brass With Gold Plated   |        |        |        |        |        |        |
| 螺丝材料 / Screw material         | 黄铜镀镍 / Brass With Nickel Plated |        |        |        |        |        |        |
| 壳体材料 / Outer shell material   | 黄铜镀镍 / Brass With Nickel Plated |        |        |        |        |        |        |
| 胶圈材料 / Gasket material        | 氟胶圈 / Fluorine Ring             |        |        |        |        |        |        |

## M12母直头金属款组装式插头 螺钉压接 屏蔽

产品图 / Product photo



尺寸图 / Dimension

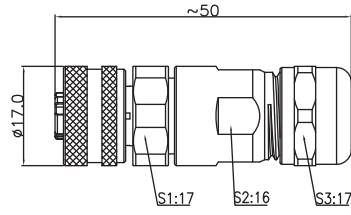

针位分布前视图 / Pin assignment front view

|        | 2 Pin | 3 Pin | 4 Pin | 5 Pin | 6 Pin | 7 Pin | 8 Pin |
|--------|-------|-------|-------|-------|-------|-------|-------|
| A-code |       |       |       |       |       |       |       |
| B-code |       |       |       |       |       |       |       |
| D-code |       |       |       |       |       |       |       |

订货信息 / Order daec

| 芯数 / Number of cores | Coding | 料号 / Part number | Qty      |
|----------------------|--------|------------------|----------|
| 02 Pin               | A-code | M12A02-02-012    | 1000 pcs |
| 03 Pin               | A-code | M12A03-02-012    | 1000 pcs |
| 04 Pin               | A-code | M12A04-02-012    | 1000 pcs |
| 05 Pin               | A-code | M12A05-02-012    | 1000 pcs |
| 06 Pin               | A-code | M12A06-02-012    | 1000 pcs |
| 07 Pin               | A-code | M12A07-02-012    | 1000 pcs |
| 08 Pin               | A-code | M12A08-02-012    | 1000 pcs |
| 04 Pin               | B-code | M12B04-02-012    | 1000 pcs |
| 05 Pin               | B-code | M12B05-02-012    | 1000 pcs |
| 04 Pin               | D-code | M12D04-02-012    | 1000 pcs |

技术参数 / Specifications

| 芯数 / Pin                      | 02 Pin                          | 03 Pin | 04 Pin | 05 Pin | 06 Pin | 07 Pin | 08 Pin |
|-------------------------------|---------------------------------|--------|--------|--------|--------|--------|--------|
| 额定电流 / Rated current          | 4 A                             | 4 A    | 4 A    | 4 A    | 2 A    | 2 A    | 2 A    |
| 额定电压 / Rated voltage          | 250 V                           | 250 V  | 250 V  | 60 V   | 30 V   | 30 V   | 30 V   |
| 标准 / Standard                 | IEC 61076-2-101                 |        |        |        |        |        |        |
| 接线方式 / Termination            | 螺钉压接 / Screw Crimping           |        |        |        |        |        |        |
| 锁紧方式 / Connect locking system | 螺纹锁紧 / Screw Lock               |        |        |        |        |        |        |
| 防护等级 / Degree of protection   | IP66                            |        |        |        |        |        |        |
| 插拔次数 / Mechanical durability  | 500次                            |        |        |        |        |        |        |
| 工作温度 / Operation temperature  | -25 °C ~ +85 °C                 |        |        |        |        |        |        |
| 接触电阻 / Contact resistance     | ≤ 10mΩ                          |        |        |        |        |        |        |
| 绝缘电阻 / Insulation resistance  | ≥ 1000MΩ                        |        |        |        |        |        |        |
| 胶芯材料 / Housing material       | 尼龙PA66                          |        |        |        |        |        |        |
| 端子材料 / Pin material           | 黄铜镀金 / Brass With Gold Plated   |        |        |        |        |        |        |
| 螺丝材料 / Screw material         | 黄铜镀镍 / Brass With Nickel Plated |        |        |        |        |        |        |
| 壳体材料 / Outer shell material   | 黄铜镀镍 / Brass With Nickel Plated |        |        |        |        |        |        |
| 胶圈材料 / Gasket material        | 氟胶圈 / Fluorine Ring             |        |        |        |        |        |        |

## M12公直头塑胶款组装式插头 螺钉压接

产品图 / Product photo



尺寸图 / Dimension

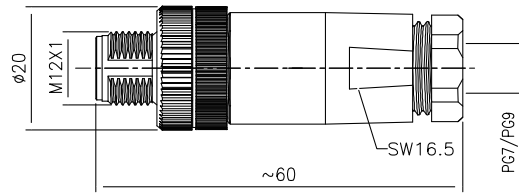

针位分布前视图 / Pin assignment front view

|        | 2 Pin | 3 Pin | 4 Pin | 5 Pin | 6 Pin | 7 Pin | 8 Pin |
|--------|-------|-------|-------|-------|-------|-------|-------|
| A-code |       |       |       |       |       |       |       |
| B-code |       |       |       |       |       |       |       |
| D-code |       |       |       |       |       |       |       |

订货信息 / Order daea

| 芯数 / Number of cores | Coding | 料号 / Part number | Qty      |
|----------------------|--------|------------------|----------|
| 02 Pin               | A-code | M12A02-01-010    | 1000 pcs |
| 03 Pin               | A-code | M12A03-01-010    | 1000 pcs |
| 04 Pin               | A-code | M12A04-01-010    | 1000 pcs |
| 05 Pin               | A-code | M12A05-01-010    | 1000 pcs |
| 06 Pin               | A-code | M12A06-01-010    | 1000 pcs |
| 07 Pin               | A-code | M12A07-01-010    | 1000 pcs |
| 08 Pin               | A-code | M12A08-01-010    | 1000 pcs |
| 05 Pin               | B-code | M12B05-01-010    | 1000 pcs |
| 04 Pin               | D-code | M12D04-01-010    | 1000 pcs |

技术参数 / Specifications

| 芯数 / Pin                      | 02 Pin                          | 03 Pin | 04 Pin | 05 Pin | 06 Pin | 07 Pin | 08 Pin |
|-------------------------------|---------------------------------|--------|--------|--------|--------|--------|--------|
| 额定电流 / Rated current          | 4 A                             | 4 A    | 4 A    | 4 A    | 2 A    | 2 A    | 2 A    |
| 额定电压 / Rated voltage          | 250 V                           | 250 V  | 250 V  | 60 V   | 30 V   | 30 V   | 30 V   |
| 标准 / Standard                 | IEC 61076-2-101                 |        |        |        |        |        |        |
| 接线方式 / Termination            | 螺钉压接 / Screw Crimping           |        |        |        |        |        |        |
| 锁紧方式 / Connect locking system | 螺纹锁紧 / Screw Lock               |        |        |        |        |        |        |
| 防护等级 / Degree of protection   | IP67                            |        |        |        |        |        |        |
| 插拔次数 / Mechanical durability  | 500次                            |        |        |        |        |        |        |
| 工作温度 / Operation temperature  | -25 °C ~ +85 °C                 |        |        |        |        |        |        |
| 接触电阻 / Contact resistance     | ≤ 10mΩ                          |        |        |        |        |        |        |
| 绝缘电阻 / Insulation resistance  | ≥ 1000MΩ                        |        |        |        |        |        |        |
| 胶芯材料 / Housing material       | 尼龙PA66                          |        |        |        |        |        |        |
| 端子材料 / Pin material           | 黄铜镀金 / Brass With Gold Plated   |        |        |        |        |        |        |
| 螺丝材料 / Screw material         | 黄铜镀镍 / Brass With Nickel Plated |        |        |        |        |        |        |
| 壳体材料 / Outer shell material   | 黄铜镀镍 / Brass With Nickel Plated |        |        |        |        |        |        |
| 胶圈材料 / Gasket material        | 氟胶圈 / Fluorine Ring             |        |        |        |        |        |        |

## M12母直头塑胶款组装式插头 螺钉压接

产品图 / Product photo



尺寸图 / Dimension

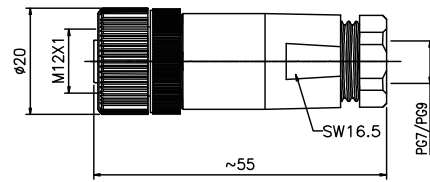

针位分布前视图 / Pin assignment front view

|        | 2 Pin | 3 Pin | 4 Pin | 5 Pin | 6 Pin | 7 Pin | 8 Pin |
|--------|-------|-------|-------|-------|-------|-------|-------|
| A-code |       |       |       |       |       |       |       |
| B-code |       |       |       |       |       |       |       |
| D-code |       |       |       |       |       |       |       |

订货信息 / Order daea

| 芯数 / Number of cores | Coding | 料号 / Part number | Qty      |
|----------------------|--------|------------------|----------|
| 02 Pin               | A-code | M12A02-02-010    | 1000 pcs |
| 03 Pin               | A-code | M12A03-02-010    | 1000 pcs |
| 04 Pin               | A-code | M12A04-02-010    | 1000 pcs |
| 05 Pin               | A-code | M12A05-02-010    | 1000 pcs |
| 06 Pin               | A-code | M12A06-02-010    | 1000 pcs |
| 07 Pin               | A-code | M12A07-02-010    | 1000 pcs |
| 08 Pin               | A-code | M12A08-02-010    | 1000 pcs |
| 05 Pin               | B-code | M12B05-02-010    | 1000 pcs |
| 04 Pin               | D-code | M12D04-02-010    | 1000 pcs |

技术参数 / Specifications

| 芯数 / Pin                      | 02 Pin                          | 03 Pin | 04 Pin | 05 Pin | 06 Pin | 07 Pin | 08 Pin |
|-------------------------------|---------------------------------|--------|--------|--------|--------|--------|--------|
| 额定电流 / Rated current          | 4 A                             | 4 A    | 4 A    | 4 A    | 2 A    | 2 A    | 2 A    |
| 额定电压 / Rated voltage          | 250 V                           | 250 V  | 250 V  | 60 V   | 30 V   | 30 V   | 30 V   |
| 标准 / Standard                 | IEC 61076-2-101                 |        |        |        |        |        |        |
| 接线方式 / Termination            | 螺钉压接 / Screw Crimping           |        |        |        |        |        |        |
| 锁紧方式 / Connect locking system | 螺纹锁紧 / Screw Lock               |        |        |        |        |        |        |
| 防护等级 / Degree of protection   | IP67                            |        |        |        |        |        |        |
| 插拔次数 / Mechanical durability  | 500次                            |        |        |        |        |        |        |
| 工作温度 / Operation temperature  | -25 °C ~ +85 °C                 |        |        |        |        |        |        |
| 接触电阻 / Contact resistance     | ≤ 10mΩ                          |        |        |        |        |        |        |
| 绝缘电阻 / Insulation resistance  | ≥ 1000MΩ                        |        |        |        |        |        |        |
| 胶芯材料 / Housing material       | 尼龙PA66                          |        |        |        |        |        |        |
| 端子材料 / Pin material           | 黄铜镀金 / Brass With Gold Plated   |        |        |        |        |        |        |
| 螺丝材料 / Screw material         | 黄铜镀镍 / Brass With Nickel Plated |        |        |        |        |        |        |
| 壳体材料 / Outer shell material   | 黄铜镀镍 / Brass With Nickel Plated |        |        |        |        |        |        |
| 胶圈材料 / Gasket material        | 氟胶圈 / Fluorine Ring             |        |        |        |        |        |        |

## M12公弯头塑胶款组装式插头 螺钉压接

产品图 / Product photo



尺寸图 / Dimension

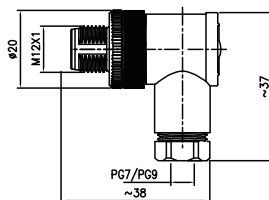

针位分布前视图 / Pin assignment front view

|        | 2 Pin | 3 Pin | 4 Pin | 5 Pin | 6 Pin | 7 Pin | 8 Pin |
|--------|-------|-------|-------|-------|-------|-------|-------|
| A-code |       |       |       |       |       |       |       |
| B-code |       |       |       |       |       |       |       |
| D-code |       |       |       |       |       |       |       |

订货信息 / Order daea

| 芯数 / Number of cores | Coding | 料号 / Part number | Qty      |
|----------------------|--------|------------------|----------|
| 02 Pin               | A-code | M12A02-01-011    | 1000 pcs |
| 03 Pin               | A-code | M12A03-01-011    | 1000 pcs |
| 04 Pin               | A-code | M12A04-01-011    | 1000 pcs |
| 05 Pin               | A-code | M12A05-01-011    | 1000 pcs |
| 06 Pin               | A-code | M12A06-01-011    | 1000 pcs |
| 07 Pin               | A-code | M12A07-01-011    | 1000 pcs |
| 08 Pin               | A-code | M12A08-01-011    | 1000 pcs |
| 05 Pin               | B-code | M12B05-01-011    | 1000 pcs |
| 04 Pin               | D-code | M12D04-01-011    | 1000 pcs |

技术参数 / Specifications

| 芯数 / Pin                      | 02 Pin                          | 03 Pin | 04 Pin | 05 Pin | 06 Pin | 07 Pin | 08 Pin |
|-------------------------------|---------------------------------|--------|--------|--------|--------|--------|--------|
| 额定电流 / Rated current          | 4 A                             | 4 A    | 4 A    | 4 A    | 2 A    | 2 A    | 2 A    |
| 额定电压 / Rated voltage          | 250 V                           | 250 V  | 250 V  | 60 V   | 30 V   | 30 V   | 30 V   |
| 标准 / Standard                 | IEC 61076-2-101                 |        |        |        |        |        |        |
| 接线方式 / Termination            | 螺钉压接 / Screw Crimping           |        |        |        |        |        |        |
| 锁紧方式 / Connect locking system | 螺纹锁紧 / Screw Lock               |        |        |        |        |        |        |
| 防护等级 / Degree of protection   | IP67                            |        |        |        |        |        |        |
| 插拔次数 / Mechanical durability  | 500次                            |        |        |        |        |        |        |
| 工作温度 / Operation temperature  | -25 °C ~ +85 °C                 |        |        |        |        |        |        |
| 接触电阻 / Contact resistance     | ≤ 10mΩ                          |        |        |        |        |        |        |
| 绝缘电阻 / Insulation resistance  | ≥ 1000MΩ                        |        |        |        |        |        |        |
| 胶芯材料 / Housing material       | 尼龙PA66                          |        |        |        |        |        |        |
| 端子材料 / Pin material           | 黄铜镀金 / Brass With Gold Plated   |        |        |        |        |        |        |
| 螺丝材料 / Screw material         | 黄铜镀镍 / Brass With Nickel Plated |        |        |        |        |        |        |
| 壳体材料 / Outer shell material   | 黄铜镀镍 / Brass With Nickel Plated |        |        |        |        |        |        |
| 胶圈材料 / Gasket material        | 氟胶圈 / Fluorine Ring             |        |        |        |        |        |        |

## M12 母弯头塑胶款组装式插头 螺钉压接

产品图 / Product photo



尺寸图 / Dimension

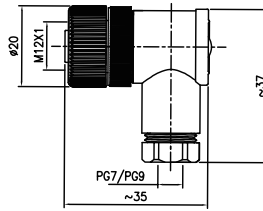

针位分布前视图 / Pin assignment front view

|        | 2 Pin | 3 Pin | 4 Pin | 5 Pin | 6 Pin | 7 Pin | 8 Pin |
|--------|-------|-------|-------|-------|-------|-------|-------|
| A-code |       |       |       |       |       |       |       |
| B-code |       |       |       |       |       |       |       |
| D-code |       |       |       |       |       |       |       |

订货信息 / Order daec

| 芯数 / Number of cores | Coding | 料号 / Part number | Qty      |
|----------------------|--------|------------------|----------|
| 02 Pin               | A-code | M12A02-02-011    | 1000 pcs |
| 03 Pin               | A-code | M12A03-02-011    | 1000 pcs |
| 04 Pin               | A-code | M12A04-02-011    | 1000 pcs |
| 05 Pin               | A-code | M12A05-02-011    | 1000 pcs |
| 06 Pin               | A-code | M12A06-02-011    | 1000 pcs |
| 07 Pin               | A-code | M12A07-02-011    | 1000 pcs |
| 08 Pin               | A-code | M12A08-02-011    | 1000 pcs |
| 05 Pin               | B-code | M12B05-02-011    | 1000 pcs |
| 04 Pin               | D-code | M12D04-02-011    | 1000 pcs |

技术参数 / Specifications

| 芯数 / Pin                      | 02 Pin                          | 03 Pin | 04 Pin | 05 Pin | 06 Pin | 07 Pin | 08 Pin |
|-------------------------------|---------------------------------|--------|--------|--------|--------|--------|--------|
| 额定电流 / Rated current          | 4 A                             | 4 A    | 4 A    | 4 A    | 2 A    | 2 A    | 2 A    |
| 额定电压 / Rated voltage          | 250 V                           | 250 V  | 250 V  | 60 V   | 30 V   | 30 V   | 30 V   |
| 标准 / Standard                 | IEC 61076-2-101                 |        |        |        |        |        |        |
| 接线方式 / Termination            | 螺钉压接 / Screw Crimping           |        |        |        |        |        |        |
| 锁紧方式 / Connect locking system | 螺纹锁紧 / Screw Lock               |        |        |        |        |        |        |
| 防护等级 / Degree of protection   | IP67                            |        |        |        |        |        |        |
| 插拔次数 / Mechanical durability  | 500次                            |        |        |        |        |        |        |
| 工作温度 / Operation temperature  | -25 °C ~ +85 °C                 |        |        |        |        |        |        |
| 接触电阻 / Contact resistance     | $\leq 10\text{m}\Omega$         |        |        |        |        |        |        |
| 绝缘电阻 / Insulation resistance  | $\geq 1000\text{M}\Omega$       |        |        |        |        |        |        |
| 胶芯材料 / Housing material       | 尼龙PA66                          |        |        |        |        |        |        |
| 端子材料 / Pin material           | 黄铜镀金 / Brass With Gold Plated   |        |        |        |        |        |        |
| 螺丝材料 / Screw material         | 黄铜镀镍 / Brass With Nickel Plated |        |        |        |        |        |        |
| 壳体材料 / Outer shell material   | 黄铜镀镍 / Brass With Nickel Plated |        |        |        |        |        |        |
| 胶圈材料 / Gasket material        | 氟胶圈 / Fluorine Ring             |        |        |        |        |        |        |

## M12前锁面板式线端公头 焊线型M12 SW15T

产品图 / Product photo



尺寸图 / Dimension

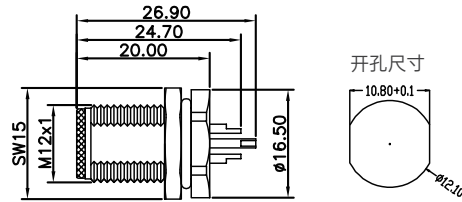

针位分布前视图 / Pin assignment front view

|        | 2 Pin | 3 Pin | 4 Pin | 5 Pin | 6 Pin | 7 Pin | 8 Pin |
|--------|-------|-------|-------|-------|-------|-------|-------|
| A-code |       |       |       |       |       |       |       |
| B-code |       |       |       |       |       |       |       |
| D-code |       |       |       |       |       |       |       |

订货信息 / Order daec

| 芯数 / Number of cores | Coding | 料号 / Part number | Qty      | 芯数 / Number of cores | Coding | 料号 / Part number | Qty      |
|----------------------|--------|------------------|----------|----------------------|--------|------------------|----------|
| 02 Pin               | A-code | M12A02-03-109    | 1000 pcs | 02 Pin               | B-code | M12B02-03-109    | 1000 pcs |
| 03 Pin               | A-code | M12A03-03-109    | 1000 pcs | 03 Pin               | B-code | M12B03-03-109    | 1000 pcs |
| 04 Pin               | A-code | M12A04-03-109    | 1000 pcs | 04 Pin               | B-code | M12B04-03-109    | 1000 pcs |
| 05 Pin               | A-code | M12A05-03-109    | 1000 pcs | 05 Pin               | B-code | M12B05-03-109    | 1000 pcs |
| 06 Pin               | A-code | M12A06-03-109    | 1000 pcs | 02 Pin               | D-code | M12D02-03-109    | 1000 pcs |
| 07 Pin               | A-code | M12A07-03-109    | 1000 pcs | 03 Pin               | D-code | M12D03-03-109    | 1000 pcs |
| 08 Pin               | A-code | M12A08-03-109    | 1000 pcs | 04 Pin               | D-code | M12D04-03-109    | 1000 pcs |

技术参数 / Specifications

| 芯数 / Pin                      | 02 Pin                          | 03 Pin | 04 Pin | 05 Pin | 06 Pin | 07 Pin | 08 Pin |
|-------------------------------|---------------------------------|--------|--------|--------|--------|--------|--------|
| 额定电流 / Rated current          | 4 A                             | 4 A    | 4 A    | 4 A    | 2 A    | 2 A    | 2 A    |
| 额定电压 / Rated voltage          | 60 V                            | 60 V   | 60 V   | 60 V   | 30 V   | 30 V   | 30 V   |
| 标准 / Standard                 | IEC 61076-2-101                 |        |        |        |        |        |        |
| 接线方式 / Termination            | 焊线 / Solder                     |        |        |        |        |        |        |
| 锁紧方式 / Connect locking system | 螺纹锁紧 / Screw Lock               |        |        |        |        |        |        |
| 防护等级 / Degree of protection   | IP67 / IP68                     |        |        |        |        |        |        |
| 插拔次数 / Mechanical durability  | 500次                            |        |        |        |        |        |        |
| 工作温度 / Operation temperature  | -25 °C ~ +85 °C                 |        |        |        |        |        |        |
| 接触电阻 / Contact resistance     | ≤ 10mΩ                          |        |        |        |        |        |        |
| 绝缘电阻 / Insulation resistance  | ≥ 1000MΩ                        |        |        |        |        |        |        |
| 胶芯材料 / Housing material       | 尼龙PA66                          |        |        |        |        |        |        |
| 端子材料 / Pin material           | 黄铜镀金 / Brass With Gold Plated   |        |        |        |        |        |        |
| 螺丝材料 / Screw                  | 黄铜镀镍 / Brass With Nickel Plated |        |        |        |        |        |        |
| 壳体材料 / Outer shell material   | 黄铜镀镍 / Brass With Nickel Plated |        |        |        |        |        |        |
| 胶圈材料 / Gasket material        | 氟胶圈 / Fluorine Ring             |        |        |        |        |        |        |



## M12前锁面板式线端公头 焊线型M12 SW17T

产品图 / Product photo



尺寸图 / Dimension

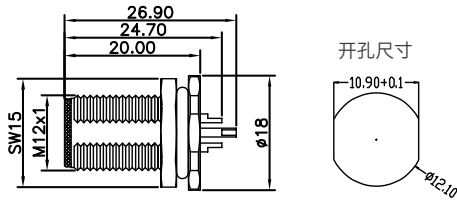

针位分布前视图 / Pin assignment front view

|        | 2 Pin | 3 Pin | 4 Pin | 5 Pin | 6 Pin | 7 Pin | 8 Pin |
|--------|-------|-------|-------|-------|-------|-------|-------|
| A-code |       |       |       |       |       |       |       |
| B-code |       |       |       |       |       |       |       |
| D-code |       |       |       |       |       |       |       |

订货信息 / Order daec

| 芯数 / Number of cores | Coding | 料号 / Part number | Qty      | 芯数 / Number of cores | Coding | 料号 / Part number | Qty      |
|----------------------|--------|------------------|----------|----------------------|--------|------------------|----------|
| 02 Pin               | A-code | M12A02-03-110    | 1000 pcs | 02 Pin               | B-code | M12B02-03-110    | 1000 pcs |
| 03 Pin               | A-code | M12A03-03-110    | 1000 pcs | 03 Pin               | B-code | M12B03-03-110    | 1000 pcs |
| 04 Pin               | A-code | M12A04-03-110    | 1000 pcs | 04 Pin               | B-code | M12B04-03-110    | 1000 pcs |
| 05 Pin               | A-code | M12A05-03-110    | 1000 pcs | 05 Pin               | B-code | M12B05-03-110    | 1000 pcs |
| 06 Pin               | A-code | M12A06-03-110    | 1000 pcs | 02 Pin               | D-code | M12D02-03-110    | 1000 pcs |
| 07 Pin               | A-code | M12A07-03-110    | 1000 pcs | 03 Pin               | D-code | M12D03-03-110    | 1000 pcs |
| 08 Pin               | A-code | M12A08-03-110    | 1000 pcs | 04 Pin               | D-code | M12D04-03-110    | 1000 pcs |

技术参数 / Specifications

| 芯数 / Pin                      | 02 Pin                          | 03 Pin | 04 Pin | 05 Pin | 06 Pin | 07 Pin | 08 Pin |
|-------------------------------|---------------------------------|--------|--------|--------|--------|--------|--------|
| 额定电流 / Rated current          | 4 A                             | 4 A    | 4 A    | 4 A    | 2 A    | 2 A    | 2 A    |
| 额定电压 / Rated voltage          | 60 V                            | 60 V   | 60 V   | 60 V   | 30 V   | 30 V   | 30 V   |
| 标准 / Standard                 | IEC 61076-2-101                 |        |        |        |        |        |        |
| 接线方式 / Termination            | 焊线 / Solder                     |        |        |        |        |        |        |
| 锁紧方式 / Connect locking system | 螺纹锁紧 / Screw Lock               |        |        |        |        |        |        |
| 防护等级 / Degree of protection   | IP67 / IP68                     |        |        |        |        |        |        |
| 插拔次数 / Mechanical durability  | 500次                            |        |        |        |        |        |        |
| 工作温度 / Operation temperature  | -25 °C ~ +85 °C                 |        |        |        |        |        |        |
| 接触电阻 / Contact resistance     | ≤ 10mΩ                          |        |        |        |        |        |        |
| 绝缘电阻 / Insulation resistance  | ≥ 1000MΩ                        |        |        |        |        |        |        |
| 胶芯材料 / Housing material       | 尼龙PA66                          |        |        |        |        |        |        |
| 端子材料 / Pin material           | 黄铜镀金 / Brass With Gold Plated   |        |        |        |        |        |        |
| 螺丝材料 / Screw                  | 黄铜镀镍 / Brass With Nickel Plated |        |        |        |        |        |        |
| 壳体材料 / Outer shell material   | 黄铜镀镍 / Brass With Nickel Plated |        |        |        |        |        |        |
| 胶圈材料 / Gasket material        | 氟胶圈 / Fluorine Ring             |        |        |        |        |        |        |

## M12前锁面板式线端公头 焊线型M12 SW15T

产品图 / Product photo



尺寸图 / Dimension

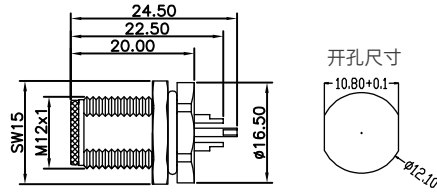

针位分布前视图 / Pin assignment front view

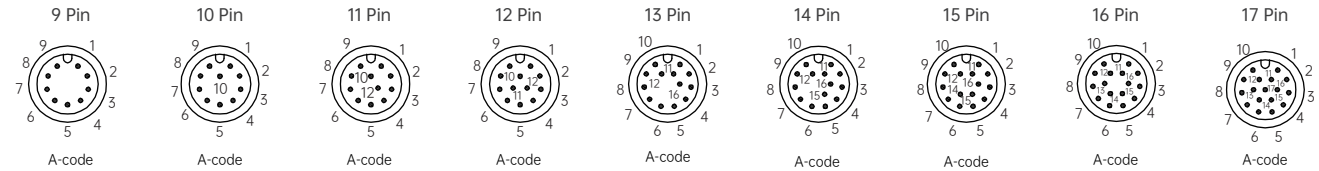

订货信息 / Order daec

| 芯数 / Number of cores | Coding | 料号 / Part number | Qty      |
|----------------------|--------|------------------|----------|
| 09 Pin               | A-code | M12A09-03-111    | 1000 pcs |
| 10 Pin               | A-code | M12A10-03-111    | 1000 pcs |
| 11 Pin               | A-code | M12A11-03-111    | 1000 pcs |
| 12 Pin               | A-code | M12A12-03-111    | 1000 pcs |
| 13 Pin               | A-code | M12A13-03-111    | 1000 pcs |
| 14 Pin               | A-code | M12A14-03-111    | 1000 pcs |
| 15 Pin               | A-code | M12A15-03-111    | 1000 pcs |
| 16 Pin               | A-code | M12A16-03-111    | 1000 pcs |
| 17 Pin               | A-code | M12A17-03-111    | 1000 pcs |

技术参数 / Specifications

| 芯数 / Pin   | 09 Pin                                    | 10 Pin | 11 Pin | 12 Pin | 13 Pin | 14 Pin | 15 Pin | 16 Pin | 17 Pin |
|--|---|--------|--------|--------|--------|--------|--------|--------|--------|
| 额定电流 / Rated current                                 | 1.5 A                                     |        |        |        |        |        |        |        |        |
| 额定电压 / Rated voltage                                 | 30 V                                      |        |        |        |        |        |        |        |        |
| 线规 (mm <sup>2</sup> ) / Wire gauge(mm <sup>2</sup> ) | 0.14mm <sup>2</sup> ~ 0.75mm <sup>2</sup> |        |        |        |        |        |        |        |        |
| 线号 (AWG) / Wire gauge(AWG)                           | 26AWG ~ 18AWG                             |        |        |        |        |        |        |        |        |
| 标准 / Standard  | IEC 61076-2-101                           |        |        |        |        |        |        |        |        |
| 接线方式 / Termination                                   | 焊线 / Solder                               |        |        |        |        |        |        |        |        |
| 锁紧方式 / Connect locking system                        | 螺纹锁紧 / Screw Lock                         |        |        |        |        |        |        |        |        |
| 防护等级 / Degree of protection                          | IP67 / IP68                               |        |        |        |        |        |        |        |        |
| 插拔次数 / Mechanical durability                         | 500次                                      |        |        |        |        |        |        |        |        |
| 工作温度 / Operation temperature                         | -25 °C ~ +85 °C                           |        |        |        |        |        |        |        |        |
| 接触电阻 / Contact resistance                            | ≤ 10mΩ                                    |        |        |        |        |        |        |        |        |
| 绝缘电阻 / Insulation resistance                         | ≥ 1000MΩ                                  |        |        |        |        |        |        |        |        |
| 胶芯材料 / Housing material                              | 尼龙PA66                                    |        |        |        |        |        |        |        |        |
| 端子材料 / Pin material                                  | 黄铜镀金 / Brass With Gold Plated             |        |        |        |        |        |        |        |        |
| 螺丝材料 / Screw   | POM                                       |        |        |        |        |        |        |        |        |

## M12前锁面板式线端公头 焊线型M12 SW17T

产品图 / Product photo



尺寸图 / Dimension

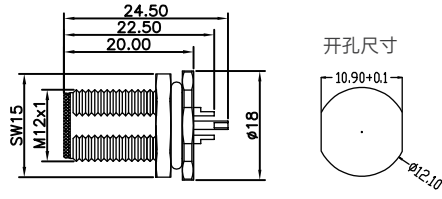

针位分布前视图 / Pin assignment front view

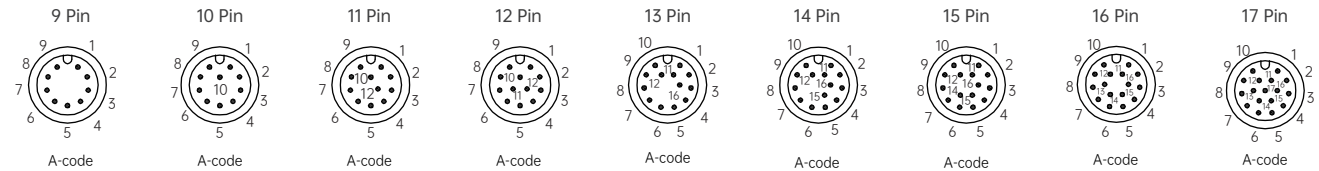

订货信息 / Order daec

| 芯数 / Number of cores | Coding | 料号 / Part number | Qty      |
|----------------------|--------|------------------|----------|
| 09 Pin               | A-code | M12A09-03-112    | 1000 pcs |
| 10 Pin               | A-code | M12A10-03-112    | 1000 pcs |
| 11 Pin               | A-code | M12A11-03-112    | 1000 pcs |
| 12 Pin               | A-code | M12A12-03-112    | 1000 pcs |
| 13 Pin               | A-code | M12A13-03-112    | 1000 pcs |
| 14 Pin               | A-code | M12A14-03-112    | 1000 pcs |
| 15 Pin               | A-code | M12A15-03-112    | 1000 pcs |
| 16 Pin               | A-code | M12A16-03-112    | 1000 pcs |
| 17 Pin               | A-code | M12A17-03-112    | 1000 pcs |

技术参数 / Specifications

| 芯数 / Pin   | 09 Pin                                    | 10 Pin | 11 Pin | 12 Pin | 13 Pin | 14 Pin | 15 Pin | 16 Pin | 17 Pin |
|--|---|--------|--------|--------|--------|--------|--------|--------|--------|
| 额定电流 / Rated current                                 | 1.5 A                                     |        |        |        |        |        |        |        |        |
| 额定电压 / Rated voltage                                 | 30 V                                      |        |        |        |        |        |        |        |        |
| 线规 (mm <sup>2</sup> ) / Wire gauge(mm <sup>2</sup> ) | 0.14mm <sup>2</sup> ~ 0.75mm <sup>2</sup> |        |        |        |        |        |        |        |        |
| 线号 (AWG) / Wire gauge(AWG)                           | 26AWG ~ 18AWG                             |        |        |        |        |        |        |        |        |
| 标准 / Standard  | IEC 61076-2-101                           |        |        |        |        |        |        |        |        |
| 接线方式 / Termination                                   | 焊线 / Solder                               |        |        |        |        |        |        |        |        |
| 锁紧方式 / Connect locking system                        | 螺纹锁紧 / Screw Lock                         |        |        |        |        |        |        |        |        |
| 防护等级 / Degree of protection                          | IP67 / IP68                               |        |        |        |        |        |        |        |        |
| 插拔次数 / Mechanical durability                         | 500次                                      |        |        |        |        |        |        |        |        |
| 工作温度 / Operation temperature                         | -25 °C ~ +85 °C                           |        |        |        |        |        |        |        |        |
| 接触电阻 / Contact resistance                            | ≤ 10mΩ                                    |        |        |        |        |        |        |        |        |
| 绝缘电阻 / Insulation resistance                         | ≥ 1000MΩ                                  |        |        |        |        |        |        |        |        |
| 胶芯材料 / Housing material                              | 尼龙PA66                                    |        |        |        |        |        |        |        |        |
| 端子材料 / Pin material                                  | 黄铜镀金 / Brass With Gold Plated             |        |        |        |        |        |        |        |        |
| 螺丝材料 / Screw   | POM                                       |        |        |        |        |        |        |        |        |

## M12前锁面板式线端公头 焊线型M16.PG9 SW17T

产品图 / Product photo



尺寸图 / Dimension

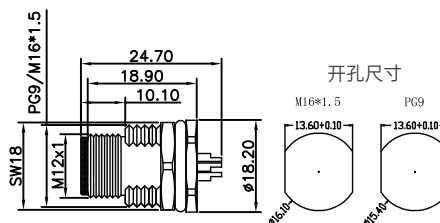

针位分布前视图 / Pin assignment front view

|        | 2 Pin | 3 Pin | 4 Pin | 5 Pin | 6 Pin | 7 Pin | 8 Pin |
|--------|-------|-------|-------|-------|-------|-------|-------|
| A-code |       |       |       |       |       |       |       |
| B-code |       |       |       |       |       |       |       |
| D-code |       |       |       |       |       |       |       |

订货信息 / Order daec

| 芯数 / Number of cores | Coding | 料号 / Part number      | Qty      | 芯数 / Number of cores | Coding | 料号 / Part number      | Qty      |
|----------------------|--------|-----------------------|----------|----------------------|--------|-----------------------|----------|
| 02 Pin               | A-code | M12A02-03-122-M16/PG9 | 1000 pcs | 02 Pin               | B-code | M12B02-03-122-M16/PG9 | 1000 pcs |
| 03 Pin               | A-code | M12A03-03-122-M16/PG9 | 1000 pcs | 03 Pin               | B-code | M12B03-03-122-M16/PG9 | 1000 pcs |
| 04 Pin               | A-code | M12A04-03-122-M16/PG9 | 1000 pcs | 04 Pin               | B-code | M12B04-03-122-M16/PG9 | 1000 pcs |
| 05 Pin               | A-code | M12A05-03-122-M16/PG9 | 1000 pcs | 05 Pin               | B-code | M12B05-03-122-M16/PG9 | 1000 pcs |
| 06 Pin               | A-code | M12A06-03-122-M16/PG9 | 1000 pcs | 02 Pin               | D-code | M12D02-03-122-M16/PG9 | 1000 pcs |
| 07 Pin               | A-code | M12A07-03-122-M16/PG9 | 1000 pcs | 03 Pin               | D-code | M12D03-03-122-M16/PG9 | 1000 pcs |
| 08 Pin               | A-code | M12A08-03-122-M16/PG9 | 1000 pcs | 04 Pin               | D-code | M12D04-03-122-M16/PG9 | 1000 pcs |

技术参数 / Specifications

| 芯数 / Pin                      | 02 Pin                          | 03 Pin | 04 Pin | 05 Pin | 06 Pin | 07 Pin | 08 Pin |
|-------------------------------|---------------------------------|--------|--------|--------|--------|--------|--------|
| 额定电流 / Rated current          | 4 A                             | 4 A    | 4 A    | 4 A    | 2 A    | 2 A    | 2 A    |
| 额定电压 / Rated voltage          | 60 V                            | 60 V   | 60 V   | 60 V   | 30 V   | 30 V   | 30 V   |
| 标准 / Standard                 | IEC 61076-2-101                 |        |        |        |        |        |        |
| 接线方式 / Termination            | 焊线 / Solder                     |        |        |        |        |        |        |
| 锁紧方式 / Connect locking system | 螺纹锁紧 / Screw Lock               |        |        |        |        |        |        |
| 防护等级 / Degree of protection   | IP67 / IP68                     |        |        |        |        |        |        |
| 插拔次数 / Mechanical durability  | 500次                            |        |        |        |        |        |        |
| 工作温度 / Operation temperature  | -25 °C ~ +85 °C                 |        |        |        |        |        |        |
| 接触电阻 / Contact resistance     | ≤ 10mΩ                          |        |        |        |        |        |        |
| 绝缘电阻 / Insulation resistance  | ≥ 1000MΩ                        |        |        |        |        |        |        |
| 胶芯材料 / Housing material       | 尼龙PA66                          |        |        |        |        |        |        |
| 端子材料 / Pin material           | 黄铜镀金 / Brass With Gold Plated   |        |        |        |        |        |        |
| 螺丝材料 / Screw                  | 黄铜镀镍 / Brass With Nickel Plated |        |        |        |        |        |        |
| 壳体材料 / Outer shell material   | 黄铜镀镍 / Brass With Nickel Plated |        |        |        |        |        |        |
| 胶圈材料 / Gasket material        | 氟胶圈 / Fluorine Ring             |        |        |        |        |        |        |

## M12前锁面板式线端公头 焊线型M16.PG9 SW17T

产品图 / Product photo



尺寸图 / Dimension

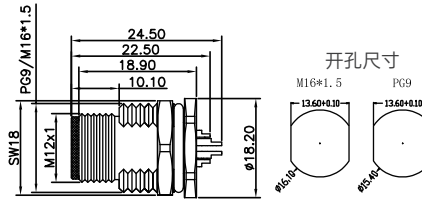

针位分布前视图 / Pin assignment front view

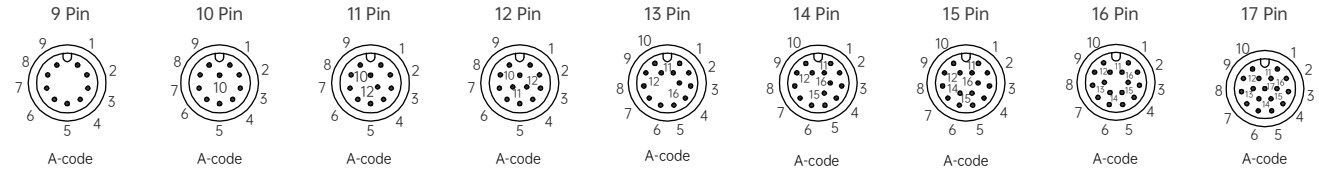

订货信息 / Order daec

| 芯数 / Number of cores | Coding | 料号 / Part number      | Qty      |
|----------------------|--------|-----------------------|----------|
| 09 Pin               | A-code | M12A09-03-123-M16/PG9 | 1000 pcs |
| 10 Pin               | A-code | M12A10-03-123-M16/PG9 | 1000 pcs |
| 11 Pin               | A-code | M12A11-03-123-M16/PG9 | 1000 pcs |
| 12 Pin               | A-code | M12A12-03-123-M16/PG9 | 1000 pcs |
| 13 Pin               | A-code | M12A13-03-123-M16/PG9 | 1000 pcs |
| 14 Pin               | A-code | M12A14-03-123-M16/PG9 | 1000 pcs |
| 15 Pin               | A-code | M12A15-03-123-M16/PG9 | 1000 pcs |
| 16 Pin               | A-code | M12A16-03-123-M16/PG9 | 1000 pcs |
| 17 Pin               | A-code | M12A17-03-123-M16/PG9 | 1000 pcs |

技术参数 / Specifications

| 芯数 / Pin   | 09 Pin                                    | 10 Pin | 11 Pin | 12 Pin | 13 Pin | 14 Pin | 15 Pin | 16 Pin | 17 Pin |
|--|---|--------|--------|--------|--------|--------|--------|--------|--------|
| 额定电流 / Rated current                                 | 1.5 A                                     |        |        |        |        |        |        |        |        |
| 额定电压 / Rated voltage                                 | 30 V                                      |        |        |        |        |        |        |        |        |
| 线规 (mm <sup>2</sup> ) / Wire gauge(mm <sup>2</sup> ) | 0.14mm <sup>2</sup> ~ 0.75mm <sup>2</sup> |        |        |        |        |        |        |        |        |
| 线号 (AWG) / Wire gauge(AWG)                           | 26AWG ~ 18AWG                             |        |        |        |        |        |        |        |        |
| 标准 / Standard  | IEC 61076-2-101                           |        |        |        |        |        |        |        |        |
| 接线方式 / Termination                                   | 焊线 / Solder                               |        |        |        |        |        |        |        |        |
| 锁紧方式 / Connect locking system                        | 螺纹锁紧 / Screw Lock                         |        |        |        |        |        |        |        |        |
| 防护等级 / Degree of protection                          | IP67 / IP68                               |        |        |        |        |        |        |        |        |
| 插拔次数 / Mechanical durability                         | 500次                                      |        |        |        |        |        |        |        |        |
| 工作温度 / Operation temperature                         | -25 °C ~ +85 °C                           |        |        |        |        |        |        |        |        |
| 接触电阻 / Contact resistance                            | ≤ 10mΩ                                    |        |        |        |        |        |        |        |        |
| 绝缘电阻 / Insulation resistance                         | ≥ 1000MΩ                                  |        |        |        |        |        |        |        |        |
| 胶芯材料 / Housing material                              | 尼龙PA66                                    |        |        |        |        |        |        |        |        |
| 端子材料 / Pin material                                  | 黄铜镀金 / Brass With Gold Plated             |        |        |        |        |        |        |        |        |
| 螺丝材料 / Screw   | POM                                       |        |        |        |        |        |        |        |        |

## M12前锁面板式板端公头 焊线型M12 SW15T-26.1L

产品图 / Product photo



尺寸图 / Dimension

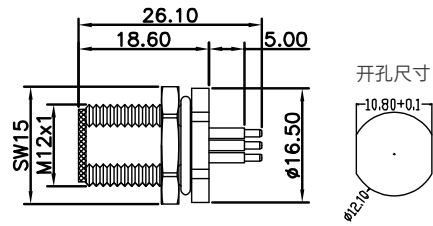

针位分布前视图 / Pin assignment front view

|        | 2 Pin | 3 Pin | 4 Pin | 5 Pin | 6 Pin | 7 Pin | 8 Pin |
|--------|-------|-------|-------|-------|-------|-------|-------|
| A-code |       |       |       |       |       |       |       |
| B-code |       |       |       |       |       |       |       |
| D-code |       |       |       |       |       |       |       |

订货信息 / Order daea

| 芯数 / Number of cores | Coding | 料号 / Part number | Qty      | 芯数 / Number of cores | Coding | 料号 / Part number | Qty      |
|----------------------|--------|------------------|----------|----------------------|--------|------------------|----------|
| 02 Pin               | A-code | M12A02-03-128    | 1000 pcs | 02 Pin               | B-code | M12B02-03-128    | 1000 pcs |
| 03 Pin               | A-code | M12A03-03-128    | 1000 pcs | 03 Pin               | B-code | M12B03-03-128    | 1000 pcs |
| 04 Pin               | A-code | M12A04-03-128    | 1000 pcs | 04 Pin               | B-code | M12B04-03-128    | 1000 pcs |
| 05 Pin               | A-code | M12A05-03-128    | 1000 pcs | 05 Pin               | B-code | M12B05-03-128    | 1000 pcs |
| 06 Pin               | A-code | M12A06-03-128    | 1000 pcs | 02 Pin               | D-code | M12D02-03-128    | 1000 pcs |
| 07 Pin               | A-code | M12A07-03-128    | 1000 pcs | 03 Pin               | D-code | M12D03-03-128    | 1000 pcs |
| 08 Pin               | A-code | M12A08-03-128    | 1000 pcs | 04 Pin               | D-code | M12D04-03-128    | 1000 pcs |

技术参数 / Specifications

| 芯数 / Pin                      | 02 Pin                          | 03 Pin | 04 Pin | 05 Pin | 06 Pin | 07 Pin | 08 Pin |
|-------------------------------|---------------------------------|--------|--------|--------|--------|--------|--------|
| 额定电流 / Rated current          | 4 A                             | 4 A    | 4 A    | 4 A    | 2 A    | 2 A    | 2 A    |
| 额定电压 / Rated voltage          | 60 V                            | 60 V   | 60 V   | 60 V   | 30 V   | 30 V   | 30 V   |
| 标准 / Standard                 | IEC 61076-2-101                 |        |        |        |        |        |        |
| 接线方式 / Termination            | 焊线 / Solder                     |        |        |        |        |        |        |
| 锁紧方式 / Connect locking system | 螺纹锁紧 / Screw Lock               |        |        |        |        |        |        |
| 防护等级 / Degree of protection   | IP67 / IP68                     |        |        |        |        |        |        |
| 插拔次数 / Mechanical durability  | 500次                            |        |        |        |        |        |        |
| 工作温度 / Operation temperature  | -25 °C ~ +85 °C                 |        |        |        |        |        |        |
| 接触电阻 / Contact resistance     | ≤ 10mΩ                          |        |        |        |        |        |        |
| 绝缘电阻 / Insulation resistance  | ≥ 1000MΩ                        |        |        |        |        |        |        |
| 胶芯材料 / Housing material       | 尼龙PA66                          |        |        |        |        |        |        |
| 端子材料 / Pin material           | 黄铜镀金 / Brass With Gold Plated   |        |        |        |        |        |        |
| 螺丝材料 / Screw                  | 黄铜镀镍 / Brass With Nickel Plated |        |        |        |        |        |        |
| 壳体材料 / Outer shell material   | 黄铜镀镍 / Brass With Nickel Plated |        |        |        |        |        |        |
| 胶圈材料 / Gasket material        | 氟胶圈 / Fluorine Ring             |        |        |        |        |        |        |

## M12前锁面板式板端公头 焊板型M16.PG9 SW17T-26.1L

产品图 / Product photo



尺寸图 / Dimension

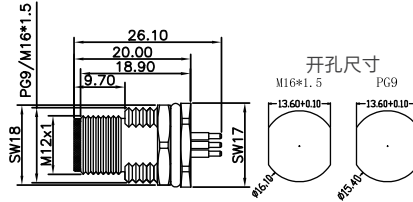

针位分布前视图 / Pin assignment front view

|        | 2 Pin | 3 Pin | 4 Pin | 5 Pin | 6 Pin | 7 Pin | 8 Pin |
|--------|-------|-------|-------|-------|-------|-------|-------|
| A-code |       |       |       |       |       |       |       |
| B-code |       |       |       |       |       |       |       |
| D-code |       |       |       |       |       |       |       |

订货信息 / Order daec

| 芯数 / Number of cores | Coding | 料号 / Part number      | Qty      | 芯数 / Number of cores | Coding | 料号 / Part number      | Qty      |
|----------------------|--------|-----------------------|----------|----------------------|--------|-----------------------|----------|
| 02 Pin               | A-code | M12A02-03-125-M16/PG9 | 1000 pcs | 02 Pin               | B-code | M12B02-03-125-M16/PG9 | 1000 pcs |
| 03 Pin               | A-code | M12A03-03-125-M16/PG9 | 1000 pcs | 03 Pin               | B-code | M12B03-03-125-M16/PG9 | 1000 pcs |
| 04 Pin               | A-code | M12A04-03-125-M16/PG9 | 1000 pcs | 04 Pin               | B-code | M12B04-03-125-M16/PG9 | 1000 pcs |
| 05 Pin               | A-code | M12A05-03-125-M16/PG9 | 1000 pcs | 05 Pin               | B-code | M12B05-03-125-M16/PG9 | 1000 pcs |
| 06 Pin               | A-code | M12A06-03-125-M16/PG9 | 1000 pcs | 02 Pin               | D-code | M12D02-03-125-M16/PG9 | 1000 pcs |
| 07 Pin               | A-code | M12A07-03-125-M16/PG9 | 1000 pcs | 03 Pin               | D-code | M12D03-03-125-M16/PG9 | 1000 pcs |
| 08 Pin               | A-code | M12A08-03-125-M16/PG9 | 1000 pcs | 04 Pin               | D-code | M12D04-03-125-M16/PG9 | 1000 pcs |

技术参数 / Specifications

| 芯数 / Pin                      | 02 Pin                          | 03 Pin | 04 Pin | 05 Pin | 06 Pin | 07 Pin | 08 Pin |
|-------------------------------|---------------------------------|--------|--------|--------|--------|--------|--------|
| 额定电流 / Rated current          | 4 A                             | 4 A    | 4 A    | 4 A    | 2 A    | 2 A    | 2 A    |
| 额定电压 / Rated voltage          | 60 V                            | 60 V   | 60 V   | 60 V   | 30 V   | 30 V   | 30 V   |
| 标准 / Standard                 | IEC 61076-2-101                 |        |        |        |        |        |        |
| 接线方式 / Termination            | 浸焊 / Dip-Solder                 |        |        |        |        |        |        |
| 锁紧方式 / Connect locking system | 螺纹锁紧 / Screw Lock               |        |        |        |        |        |        |
| 防护等级 / Degree of protection   | IP67 / IP68                     |        |        |        |        |        |        |
| 插拔次数 / Mechanical durability  | 500次                            |        |        |        |        |        |        |
| 工作温度 / Operation temperature  | -25 °C ~ +85 °C                 |        |        |        |        |        |        |
| 接触电阻 / Contact resistance     | ≤ 10mΩ                          |        |        |        |        |        |        |
| 绝缘电阻 / Insulation resistance  | ≥ 1000MΩ                        |        |        |        |        |        |        |
| 胶芯材料 / Housing material       | 尼龙PA66                          |        |        |        |        |        |        |
| 端子材料 / Pin material           | 黄铜镀金 / Brass With Gold Plated   |        |        |        |        |        |        |
| 螺丝材料 / Screw                  | 黄铜镀镍 / Brass With Nickel Plated |        |        |        |        |        |        |
| 壳体材料 / Outer shell material   | 黄铜镀镍 / Brass With Nickel Plated |        |        |        |        |        |        |
| 胶圈材料 / Gasket material        | 氟胶圈 / Fluorine Ring             |        |        |        |        |        |        |

## M12前锁面板式板端公头 焊板型M16.PG9 SW17T-26.1L

产品图 / Product photo



尺寸图 / Dimension

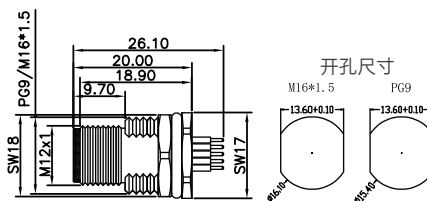

针位分布前视图 / Pin assignment front view

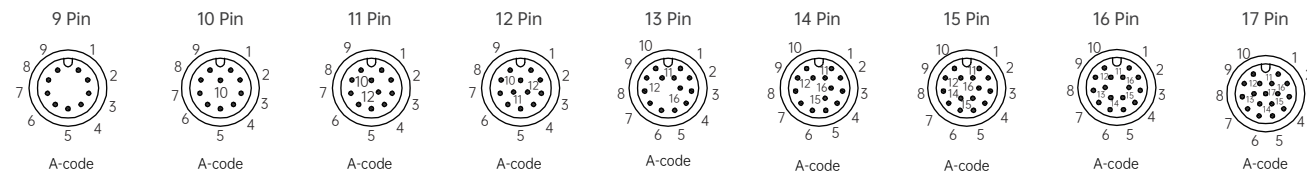

订货信息 / Order daec

| 芯数 / Number of cores | Coding | 料号 / Part number      | Qty      |
|----------------------|--------|-----------------------|----------|
| 09 Pin               | A-code | M12A09-03-126-M16/PG9 | 1000 pcs |
| 10 Pin               | A-code | M12A10-03-126-M16/PG9 | 1000 pcs |
| 11 Pin               | A-code | M12A11-03-126-M16/PG9 | 1000 pcs |
| 12 Pin               | A-code | M12A12-03-126-M16/PG9 | 1000 pcs |
| 13 Pin               | A-code | M12A13-03-126-M16/PG9 | 1000 pcs |
| 14 Pin               | A-code | M12A14-03-126-M16/PG9 | 1000 pcs |
| 15 Pin               | A-code | M12A15-03-126-M16/PG9 | 1000 pcs |
| 16 Pin               | A-code | M12A16-03-126-M16/PG9 | 1000 pcs |
| 17 Pin               | A-code | M12A17-03-126-M16/PG9 | 1000 pcs |

技术参数 / Specifications

| 芯数 / Pin   | 09 Pin                                    | 10 Pin | 11 Pin | 12 Pin | 13 Pin | 14 Pin | 15 Pin | 16 Pin | 17 Pin |
|--|---|--------|--------|--------|--------|--------|--------|--------|--------|
| 额定电流 / Rated current                                 | 1.5 A                                     |        |        |        |        |        |        |        |        |
| 额定电压 / Rated voltage                                 | 30 V                                      |        |        |        |        |        |        |        |        |
| 线规 (mm <sup>2</sup> ) / Wire gauge(mm <sup>2</sup> ) | 0.14mm <sup>2</sup> ~ 0.75mm <sup>2</sup> |        |        |        |        |        |        |        |        |
| 线号 (AWG) / Wire gauge(AWG)                           | 26AWG ~ 18AWG                             |        |        |        |        |        |        |        |        |
| 标准 / Standard  | IEC 61076-2-101                           |        |        |        |        |        |        |        |        |
| 接线方式 / Termination                                   | 浸焊 / Dip-Solder                           |        |        |        |        |        |        |        |        |
| 锁紧方式 / Connect locking system                        | 螺纹锁紧 / Screw Lock                         |        |        |        |        |        |        |        |        |
| 防护等级 / Degree of protection                          | IP67 / IP68                               |        |        |        |        |        |        |        |        |
| 插拔次数 / Mechanical durability                         | 500次                                      |        |        |        |        |        |        |        |        |
| 工作温度 / Operation temperature                         | -25 °C ~ +85 °C                           |        |        |        |        |        |        |        |        |
| 接触电阻 / Contact resistance                            | ≤ 10mΩ                                    |        |        |        |        |        |        |        |        |
| 绝缘电阻 / Insulation resistance                         | ≥ 1000MΩ                                  |        |        |        |        |        |        |        |        |
| 胶芯材料 / Housing material                              | 尼龙PA66                                    |        |        |        |        |        |        |        |        |
| 端子材料 / Pin material                                  | 黄铜镀金 / Brass With Gold Plated             |        |        |        |        |        |        |        |        |
| 螺丝材料 / Screw   | POM                                       |        |        |        |        |        |        |        |        |



## M12前锁面板式板端公头 焊板型M12 SW15T-22.1L

产品图 / Product photo



尺寸图 / Dimension

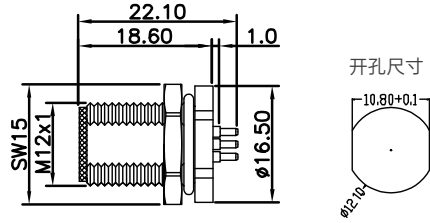

针位分布前视图 / Pin assignment front view

|        | 2 Pin | 3 Pin | 4 Pin | 5 Pin | 6 Pin | 7 Pin | 8 Pin |
|--------|-------|-------|-------|-------|-------|-------|-------|
| A-code |       |       |       |       |       |       |       |
| B-code |       |       |       |       |       |       |       |
| D-code |       |       |       |       |       |       |       |

订货信息 / Order daec

| 芯数 / Number of cores | Coding | 料号 / Part number | Qty      | 芯数 / Number of cores | Coding | 料号 / Part number | Qty      |
|----------------------|--------|------------------|----------|----------------------|--------|------------------|----------|
| 02 Pin               | A-code | M12A02-03-127    | 1000 pcs | 02 Pin               | B-code | M12B02-03-127    | 1000 pcs |
| 03 Pin               | A-code | M12A03-03-127    | 1000 pcs | 03 Pin               | B-code | M12B03-03-127    | 1000 pcs |
| 04 Pin               | A-code | M12A04-03-127    | 1000 pcs | 04 Pin               | B-code | M12B04-03-127    | 1000 pcs |
| 05 Pin               | A-code | M12A05-03-127    | 1000 pcs | 05 Pin               | B-code | M12B05-03-127    | 1000 pcs |
| 06 Pin               | A-code | M12A06-03-127    | 1000 pcs | 02 Pin               | D-code | M12D02-03-127    | 1000 pcs |
| 07 Pin               | A-code | M12A07-03-127    | 1000 pcs | 03 Pin               | D-code | M12D03-03-127    | 1000 pcs |
| 08 Pin               | A-code | M12A08-03-127    | 1000 pcs | 04 Pin               | D-code | M12D04-03-127    | 1000 pcs |

技术参数 / Specifications

| 芯数 / Pin                      | 02 Pin                          | 03 Pin | 04 Pin | 05 Pin | 06 Pin | 07 Pin | 08 Pin |
|-------------------------------|---------------------------------|--------|--------|--------|--------|--------|--------|
| 额定电流 / Rated current          | 4 A                             | 4 A    | 4 A    | 4 A    | 2 A    | 2 A    | 2 A    |
| 额定电压 / Rated voltage          | 60 V                            | 60 V   | 60 V   | 60 V   | 30 V   | 30 V   | 30 V   |
| 标准 / Standard                 | IEC 61076-2-101                 |        |        |        |        |        |        |
| 接线方式 / Termination            | 浸焊 / Dip-Solder                 |        |        |        |        |        |        |
| 锁紧方式 / Connect locking system | 螺纹锁紧 / Screw Lock               |        |        |        |        |        |        |
| 防护等级 / Degree of protection   | IP67 / IP68                     |        |        |        |        |        |        |
| 插拔次数 / Mechanical durability  | 500次                            |        |        |        |        |        |        |
| 工作温度 / Operation temperature  | -25 °C ~ +85 °C                 |        |        |        |        |        |        |
| 接触电阻 / Contact resistance     | ≤ 10mΩ                          |        |        |        |        |        |        |
| 绝缘电阻 / Insulation resistance  | ≥ 1000MΩ                        |        |        |        |        |        |        |
| 胶芯材料 / Housing material       | 尼龙PA66                          |        |        |        |        |        |        |
| 端子材料 / Pin material           | 黄铜镀金 / Brass With Gold Plated   |        |        |        |        |        |        |
| 螺丝材料 / Screw                  | 黄铜镀镍 / Brass With Nickel Plated |        |        |        |        |        |        |
| 壳体材料 / Outer shell material   | 黄铜镀镍 / Brass With Nickel Plated |        |        |        |        |        |        |
| 胶圈材料 / Gasket material        | 氟胶圈 / Fluorine Ring             |        |        |        |        |        |        |

## M12前锁面板式板端公头 焊板型M12 SW17T-30L

产品图 / Product photo



尺寸图 / Dimension

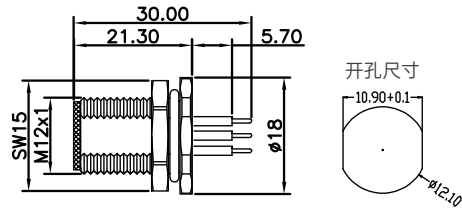

针位分布前视图 / Pin assignment front view

|        | 2 Pin | 3 Pin | 4 Pin | 5 Pin | 6 Pin | 7 Pin | 8 Pin |
|--------|-------|-------|-------|-------|-------|-------|-------|
| A-code |       |       |       |       |       |       |       |
| B-code |       |       |       |       |       |       |       |
| D-code |       |       |       |       |       |       |       |

订货信息 / Order daec

| 芯数 / Numb | er of c6æssing | 料号 / Part number | Qty      | 芯数 / Number of cores | Coding | 料号 / Part number | Qty      |
|-----------|----------------|------------------|----------|----------------------|--------|------------------|----------|
| 02 Pin    | A-code         | M12A02-03-129    | 1000 pcs | 02 Pin               | B-code | M12B02-03-129    | 1000 pcs |
| 03 Pin    | A-code         | M12A03-03-129    | 1000 pcs | 03 Pin               | B-code | M12B03-03-129    | 1000 pcs |
| 04 Pin    | A-code         | M12A04-03-129    | 1000 pcs | 04 Pin               | B-code | M12B04-03-129    | 1000 pcs |
| 05 Pin    | A-code         | M12A05-03-129    | 1000 pcs | 05 Pin               | B-code | M12B05-03-129    | 1000 pcs |
| 06 Pin    | A-code         | M12A06-03-129    | 1000 pcs | 02 Pin               | D-code | M12D02-03-129    | 1000 pcs |
| 07 Pin    | A-code         | M12A07-03-129    | 1000 pcs | 03 Pin               | D-code | M12D03-03-129    | 1000 pcs |
| 08 Pin    | A-code         | M12A08-03-129    | 1000 pcs | 04 Pin               | D-code | M12D04-03-129    | 1000 pcs |

技术参数 / Specifications

| 芯数 / Pin                      | 02 Pin                          | 03 Pin | 04 Pin | 05 Pin | 06 Pin | 07 Pin | 08 Pin |
|-------------------------------|---------------------------------|--------|--------|--------|--------|--------|--------|
| 额定电流 / Rated current          | 4 A                             | 4 A    | 4 A    | 4 A    | 2 A    | 2 A    | 2 A    |
| 额定电压 / Rated voltage          | 60 V                            | 60 V   | 60 V   | 60 V   | 30 V   | 30 V   | 30 V   |
| 标准 / Standard                 | IEC 61076-2-101                 |        |        |        |        |        |        |
| 接线方式 / Termination            | 浸焊 / Dip-Solder                 |        |        |        |        |        |        |
| 锁紧方式 / Connect locking system | 螺纹锁紧 / Screw Lock               |        |        |        |        |        |        |
| 防护等级 / Degree of protection   | IP67 / IP68                     |        |        |        |        |        |        |
| 插拔次数 / Mechanical durability  | 500次                            |        |        |        |        |        |        |
| 工作温度 / Operation temperature  | -25 °C ~ +85 °C                 |        |        |        |        |        |        |
| 接触电阻 / Contact resistance     | ≤ 10mΩ                          |        |        |        |        |        |        |
| 绝缘电阻 / Insulation resistance  | ≥ 1000MΩ                        |        |        |        |        |        |        |
| 胶芯材料 / Housing material       | 尼龙PA66                          |        |        |        |        |        |        |
| 端子材料 / Pin material           | 黄铜镀金 / Brass With Gold Plated   |        |        |        |        |        |        |
| 螺丝材料 / Screw                  | 黄铜镀镍 / Brass With Nickel Plated |        |        |        |        |        |        |
| 壳体材料 / Outer shell material   | 黄铜镀镍 / Brass With Nickel Plated |        |        |        |        |        |        |
| 胶圈材料 / Gasket material        | 氟胶圈 / Fluorine Ring             |        |        |        |        |        |        |

## M12前锁面板式板端公头 焊板型M12 SW15T-22.1L

产品图 / Product photo



尺寸图 / Dimension

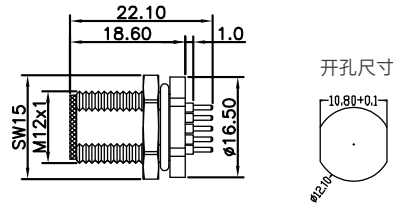

针位分布前视图 / Pin assignment front view

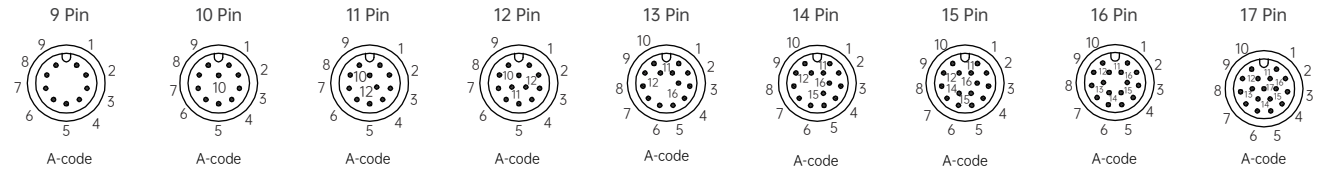

订货信息 / Order daec

| 芯数 / Number of cores | Coding | 料号 / Part number | Qty      |
|----------------------|--------|------------------|----------|
| 09 Pin               | A-code | M12A09-03-130    | 1000 pcs |
| 10 Pin               | A-code | M12A10-03-130    | 1000 pcs |
| 11 Pin               | A-code | M12A11-03-130    | 1000 pcs |
| 12 Pin               | A-code | M12A12-03-130    | 1000 pcs |
| 13 Pin               | A-code | M12A13-03-130    | 1000 pcs |
| 14 Pin               | A-code | M12A14-03-130    | 1000 pcs |
| 15 Pin               | A-code | M12A15-03-130    | 1000 pcs |
| 16 Pin               | A-code | M12A16-03-130    | 1000 pcs |
| 17 Pin               | A-code | M12A17-03-130    | 1000 pcs |

技术参数 / Specifications

| 芯数 / Pin   | 09 Pin                                    | 10 Pin | 11 Pin | 12 Pin | 13 Pin | 14 Pin | 15 Pin | 16 Pin | 17 Pin |
|--|---|--------|--------|--------|--------|--------|--------|--------|--------|
| 额定电流 / Rated current                                 | 1.5 A                                     |        |        |        |        |        |        |        |        |
| 额定电压 / Rated voltage                                 | 30 V                                      |        |        |        |        |        |        |        |        |
| 线规 (mm <sup>2</sup> ) / Wire gauge(mm <sup>2</sup> ) | 0.14mm <sup>2</sup> ~ 0.75mm <sup>2</sup> |        |        |        |        |        |        |        |        |
| 线号 (AWG) / Wire gauge(AWG)                           | 26AWG ~ 18AWG                             |        |        |        |        |        |        |        |        |
| 标准 / Standard  | IEC 61076-2-101                           |        |        |        |        |        |        |        |        |
| 接线方式 / Termination                                   | 浸焊 / Dip-Solder                           |        |        |        |        |        |        |        |        |
| 锁紧方式 / Connect locking system                        | 螺纹锁紧 / Screw Lock                         |        |        |        |        |        |        |        |        |
| 防护等级 / Degree of protection                          | IP67 / IP68                               |        |        |        |        |        |        |        |        |
| 插拔次数 / Mechanical durability                         | 500次                                      |        |        |        |        |        |        |        |        |
| 工作温度 / Operation temperature                         | -25 °C ~ +85 °C                           |        |        |        |        |        |        |        |        |
| 接触电阻 / Contact resistance                            | ≤ 10mΩ                                    |        |        |        |        |        |        |        |        |
| 绝缘电阻 / Insulation resistance                         | ≥ 1000MΩ                                  |        |        |        |        |        |        |        |        |
| 胶芯材料 / Housing material                              | 尼龙PA66                                    |        |        |        |        |        |        |        |        |
| 端子材料 / Pin material                                  | 黄铜镀金 / Brass With Gold Plated             |        |        |        |        |        |        |        |        |
| 螺丝材料 / Screw   | POM                                       |        |        |        |        |        |        |        |        |

## M12前锁面板式板端公头 焊板型M12 SW17T-30L

产品图 / Product photo



尺寸图 / Dimension

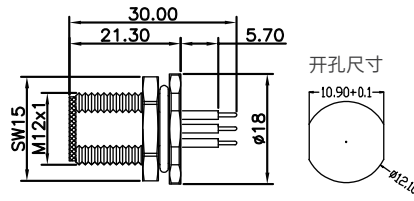

针位分布前视图 / Pin assignment front view

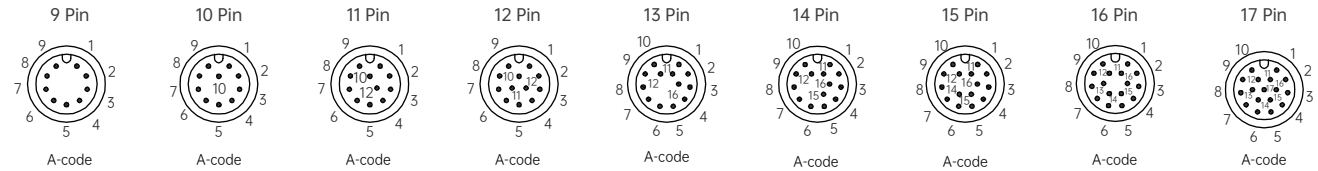

订货信息 / Order daec

| 芯数 / Number of cores | Coding | 料号 / Part number | Qty      |
|----------------------|--------|------------------|----------|
| 09 Pin               | A-code | M12A09-03-132    | 1000 pcs |
| 10 Pin               | A-code | M12A10-03-132    | 1000 pcs |
| 11 Pin               | A-code | M12A11-03-132    | 1000 pcs |
| 12 Pin               | A-code | M12A12-03-132    | 1000 pcs |
| 13 Pin               | A-code | M12A13-03-132    | 1000 pcs |
| 14 Pin               | A-code | M12A14-03-132    | 1000 pcs |
| 15 Pin               | A-code | M12A15-03-132    | 1000 pcs |
| 16 Pin               | A-code | M12A16-03-132    | 1000 pcs |
| 17 Pin               | A-code | M12A17-03-132    | 1000 pcs |

技术参数 / Specifications

| 芯数 / Pin   | 09 Pin                                    | 10 Pin | 11 Pin | 12 Pin | 13 Pin | 14 Pin | 15 Pin | 16 Pin | 17 Pin |
|--|---|--------|--------|--------|--------|--------|--------|--------|--------|
| 额定电流 / Rated current                                 | 1.5 A                                     |        |        |        |        |        |        |        |        |
| 额定电压 / Rated voltage                                 | 30 V                                      |        |        |        |        |        |        |        |        |
| 线规 (mm <sup>2</sup> ) / Wire gauge(mm <sup>2</sup> ) | 0.14mm <sup>2</sup> ~ 0.75mm <sup>2</sup> |        |        |        |        |        |        |        |        |
| 线号 (AWG) / Wire gauge(AWG)                           | 26AWG ~ 18AWG                             |        |        |        |        |        |        |        |        |
| 标准 / Standard  | IEC 61076-2-101                           |        |        |        |        |        |        |        |        |
| 接线方式 / Termination                                   | 浸焊 / Dip-Solder                           |        |        |        |        |        |        |        |        |
| 锁紧方式 / Connect locking system                        | 螺纹锁紧 / Screw Lock                         |        |        |        |        |        |        |        |        |
| 防护等级 / Degree of protection                          | IP67 / IP68                               |        |        |        |        |        |        |        |        |
| 插拔次数 / Mechanical durability                         | 500次                                      |        |        |        |        |        |        |        |        |
| 工作温度 / Operation temperature                         | -25 °C ~ +85 °C                           |        |        |        |        |        |        |        |        |
| 接触电阻 / Contact resistance                            | ≤ 10mΩ                                    |        |        |        |        |        |        |        |        |
| 绝缘电阻 / Insulation resistance                         | ≥ 1000MΩ                                  |        |        |        |        |        |        |        |        |
| 胶芯材料 / Housing material                              | 尼龙PA66                                    |        |        |        |        |        |        |        |        |
| 端子材料 / Pin material                                  | 黄铜镀金 / Brass With Gold Plated             |        |        |        |        |        |        |        |        |
| 螺丝材料 / Screw   | POM                                       |        |        |        |        |        |        |        |        |

## M12前锁面板式板端公头 焊板型M12 SW15T-26.1L

产品图 / Product photo



尺寸图 / Dimension

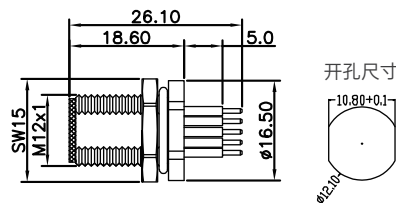

针位分布前视图 / Pin assignment front view

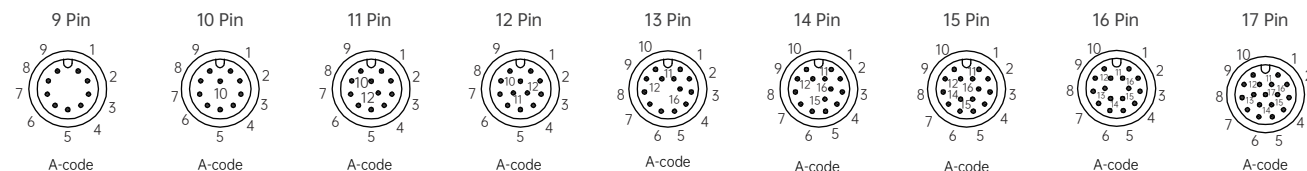

订货信息 / Order daec

| 芯数 / Number of cores | Coding | 料号 / Part number | Qty      |
|----------------------|--------|------------------|----------|
| 09 Pin               | A-code | M12A09-03-131    | 1000 pcs |
| 10 Pin               | A-code | M12A10-03-131    | 1000 pcs |
| 11 Pin               | A-code | M12A11-03-131    | 1000 pcs |
| 12 Pin               | A-code | M12A12-03-131    | 1000 pcs |
| 13 Pin               | A-code | M12A13-03-131    | 1000 pcs |
| 14 Pin               | A-code | M12A14-03-131    | 1000 pcs |
| 15 Pin               | A-code | M12A15-03-131    | 1000 pcs |
| 16 Pin               | A-code | M12A16-03-131    | 1000 pcs |
| 17 Pin               | A-code | M12A17-03-131    | 1000 pcs |

技术参数 / Specifications

| 芯数 / Pin   | 09 Pin                                    | 10 Pin | 11 Pin | 12 Pin | 13 Pin | 14 Pin | 15 Pin | 16 Pin | 17 Pin |
|--|---|--------|--------|--------|--------|--------|--------|--------|--------|
| 额定电流 / Rated current                                 | 1.5 A                                     |        |        |        |        |        |        |        |        |
| 额定电压 / Rated voltage                                 | 30 V                                      |        |        |        |        |        |        |        |        |
| 线规 (mm <sup>2</sup> ) / Wire gauge(mm <sup>2</sup> ) | 0.14mm <sup>2</sup> ~ 0.75mm <sup>2</sup> |        |        |        |        |        |        |        |        |
| 线号 (AWG) / Wire gauge(AWG)                           | 26AWG ~ 18AWG                             |        |        |        |        |        |        |        |        |
| 标准 / Standard  | IEC 61076-2-101                           |        |        |        |        |        |        |        |        |
| 接线方式 / Termination                                   | 浸焊 / Dip-Solder                           |        |        |        |        |        |        |        |        |
| 锁紧方式 / Connect locking system                        | 螺纹锁紧 / Screw Lock                         |        |        |        |        |        |        |        |        |
| 防护等级 / Degree of protection                          | IP67 / IP68                               |        |        |        |        |        |        |        |        |
| 插拔次数 / Mechanical durability                         | 500次                                      |        |        |        |        |        |        |        |        |
| 工作温度 / Operation temperature                         | -25 °C ~ +85 °C                           |        |        |        |        |        |        |        |        |
| 接触电阻 / Contact resistance                            | ≤ 10mΩ                                    |        |        |        |        |        |        |        |        |
| 绝缘电阻 / Insulation resistance                         | ≥ 1000MΩ                                  |        |        |        |        |        |        |        |        |
| 胶芯材料 / Housing material                              | 尼龙PA66                                    |        |        |        |        |        |        |        |        |
| 端子材料 / Pin material                                  | 黄铜镀金 / Brass With Gold Plated             |        |        |        |        |        |        |        |        |
| 螺丝材料 / Screw   | POM                                       |        |        |        |        |        |        |        |        |

## M12前锁面板式板端公弯头 焊板型

产品图 / Product photo



尺寸图 / Dimension

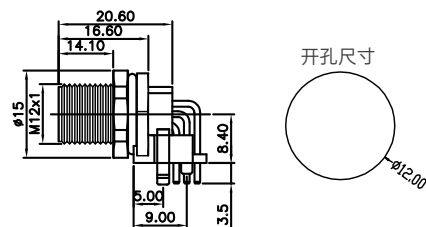

针位分布前视图 / Pin assignment front view

|        | 2 Pin | 3 Pin | 4 Pin | 5 Pin | 6 Pin | 7 Pin | 8 Pin |
|--------|-------|-------|-------|-------|-------|-------|-------|
| A-code |       |       |       |       |       |       |       |
| B-code |       |       |       |       |       |       |       |
| D-code |       |       |       |       |       |       |       |

订货信息 / Order daea

| 芯数 / Number of cores | Coding | 料号 / Part number | Qty      |
|----------------------|--------|------------------|----------|
| 02 Pin               | A-code | M12A02-03-133    | 1000 pcs |
| 03 Pin               | A-code | M12A03-03-133    | 1000 pcs |
| 04 Pin               | A-code | M12A04-03-133    | 1000 pcs |
| 05 Pin               | A-code | M12A05-03-133    | 1000 pcs |
| 06 Pin               | A-code | M12A06-03-133    | 1000 pcs |
| 07 Pin               | A-code | M12A07-03-133    | 1000 pcs |
| 08 Pin               | A-code | M12A08-03-133    | 1000 pcs |
| 05 Pin               | B-code | M12B05-03-133    | 1000 pcs |
| 04 Pin               | D-code | M12D04-03-133    | 1000 pcs |

技术参数 / Specifications

| 芯数 / Pin                      | 02 Pin                          | 03 Pin | 04 Pin | 05 Pin | 06 Pin | 07 Pin | 08 Pin |
|-------------------------------|---------------------------------|--------|--------|--------|--------|--------|--------|
| 额定电流 / Rated current          | 4 A                             | 4 A    | 4 A    | 4 A    | 2 A    | 2 A    | 2 A    |
| 额定电压 / Rated voltage          | 250 V                           | 250 V  | 250 V  | 60 V   | 30 V   | 30 V   | 30 V   |
| 标准 / Standard                 | IEC 61076-2-101                 |        |        |        |        |        |        |
| 接线方式 / Termination            | PCB                             |        |        |        |        |        |        |
| 锁紧方式 / Connect locking system | 螺纹锁紧 / Screw Lock               |        |        |        |        |        |        |
| 防护等级 / Degree of protection   | IP67 / IP68                     |        |        |        |        |        |        |
| 插拔次数 / Mechanical durability  | 500次                            |        |        |        |        |        |        |
| 工作温度 / Operation temperature  | -25 °C ~ +85 °C                 |        |        |        |        |        |        |
| 接触电阻 / Contact resistance     | ≤ 10mΩ                          |        |        |        |        |        |        |
| 绝缘电阻 / Insulation resistance  | ≥ 1000MΩ                        |        |        |        |        |        |        |
| 胶芯材料 / Housing material       | 尼龙PA66                          |        |        |        |        |        |        |
| 端子材料 / Pin material           | 黄铜镀金 / Brass With Gold Plated   |        |        |        |        |        |        |
| 螺丝材料 / Screw material         | 黄铜镀镍 / Brass With Nickel Plated |        |        |        |        |        |        |
| 壳体材料 / Outer shell material   | 黄铜镀镍 / Brass With Nickel Plated |        |        |        |        |        |        |
| 胶圈材料 / Gasket material        | 氟胶圈 / Fluorine Ring             |        |        |        |        |        |        |

## M12前锁面板式8P线端母头X编码 焊线型PG9 SW17T

产品图 / Product photo



尺寸图 / Dimension

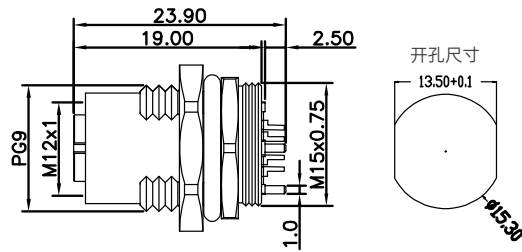

针位分布前视图 / Pin assignment front view



订货信息 / Order daea

| 芯数 / Number of cores | Coding | 料号 / Part number | Qty      |
|----------------------|--------|------------------|----------|
| 08 Pin               | X-code | M12X08-04-112    | 1000 pcs |

技术参数 / Specifications

| 芯数 / Pin                        | 08 Pin                                 |
|---------------------------------|--|
| 额定电流 / Rated current            | 0.5 A                                  |
| 额定电压 / Rated voltage            | 48 V                                   |
| 标准 / Standard                   | IEC 61076-2-101                        |
| 接线方式 / Termination              | 焊线 / Solder                            |
| 锁紧方式 / Connect locking system   | 螺纹锁紧 / Screw Lock                      |
| 防护等级 / Degree of protection     | IP67 / IP68                            |
| 插拔次数 / Mechanical durability    | 500次                                   |
| 工作温度 / Operation temperature    | -25 °C ~ +85 °C                        |
| 接触电阻 / Contact resistance       | ≤ 10mΩ                                 |
| 绝缘电阻 / Insulation resistance    | > 1000MΩ                               |
| 胶芯材料 / Housing material         | 尼龙PA66                                 |
| 端子材料 / Pin material             | 黄铜镀金 / Brass With Gold Plated          |
| 螺丝材料 / Screw                    | 锌合金镀镍 / Zinc Alloys With Nickel Plated |
| 胶圈材料 / Gasket material          | 氟胶圈 / Fluorine Ring                    |
| 屏蔽罩材料 / Shielded shell material | 锌合金镀镍 / Zinc Alloys With Nickel Plated |

## M12前锁面板式线端母头 焊线型M16/PG9 SW17T后灌胶

产品图 / Product photo



尺寸图 / Dimension

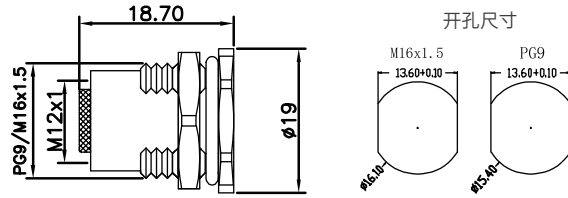

针位分布前视图 / Pin assignment front view

|        | 2 Pin | 3 Pin | 4 Pin | 5 Pin | 6 Pin | 7 Pin | 8 Pin |
|--------|-------|-------|-------|-------|-------|-------|-------|
| A-code |       |       |       |       |       |       |       |
| B-code |       |       |       |       |       |       |       |
| D-code |       |       |       |       |       |       |       |

订货信息 / Order daeo

| 芯数 / Number of cores | Coding | 料号 / Part number      | Qty      | 芯数 / Number of cores | Coding | 料号 / Part number      | Qty      |
|----------------------|--------|-----------------------|----------|----------------------|--------|-----------------------|----------|
| 02 Pin               | A-code | M12A02-04-091-M16/PG9 | 1000 pcs | 02 Pin               | B-code | M12B02-04-091-M16/PG9 | 1000 pcs |
| 03 Pin               | A-code | M12A03-04-091-M16/PG9 | 1000 pcs | 03 Pin               | B-code | M12B03-04-091-M16/PG9 | 1000 pcs |
| 04 Pin               | A-code | M12A04-04-091-M16/PG9 | 1000 pcs | 04 Pin               | B-code | M12B04-04-091-M16/PG9 | 1000 pcs |
| 05 Pin               | A-code | M12A05-04-091-M16/PG9 | 1000 pcs | 05 Pin               | B-code | M12B05-04-091-M16/PG9 | 1000 pcs |
| 06 Pin               | A-code | M12A06-04-091-M16/PG9 | 1000 pcs | 02 Pin               | D-code | M12D02-04-091-M16/PG9 | 1000 pcs |
| 07 Pin               | A-code | M12A07-04-091-M16/PG9 | 1000 pcs | 03 Pin               | D-code | M12D03-04-091-M16/PG9 | 1000 pcs |
| 08 Pin               | A-code | M12A08-04-091-M16/PG9 | 1000 pcs | 04 Pin               | D-code | M12D04-04-091-M16/PG9 | 1000 pcs |

技术参数 / Specifications

| 芯数 / Pin                      | 02 Pin                                 | 03 Pin | 04 Pin | 05 Pin | 06 Pin | 07 Pin | 08 Pin |
|-------------------------------|--|--------|--------|--------|--------|--------|--------|
| 额定电流 / Rated current          | 4 A                                    | 4 A    | 4 A    | 4 A    | 2 A    | 2 A    | 2 A    |
| 额定电压 / Rated voltage          | 60 V                                   | 60 V   | 60 V   | 60 V   | 30 V   | 30 V   | 30 V   |
| 标准 / Standard                 | IEC 61076-2-101                        |        |        |        |        |        |        |
| 接线方式 / Termination            | 焊线 / Solder                            |        |        |        |        |        |        |
| 锁紧方式 / Connect locking system | 螺纹锁紧 / Screw Lock                      |        |        |        |        |        |        |
| 防护等级 / Degree of protection   | IP67 / IP68                            |        |        |        |        |        |        |
| 插拔次数 / Mechanical durability  | 500次                                   |        |        |        |        |        |        |
| 工作温度 / Operation temperature  | -25 °C ~ +85 °C                        |        |        |        |        |        |        |
| 接触电阻 / Contact resistance     | ≤ 10mΩ                                 |        |        |        |        |        |        |
| 绝缘电阻 / Insulation resistance  | ≥ 1000MΩ                               |        |        |        |        |        |        |
| 胶芯材料 / Housing material       | 尼龙PA66                                 |        |        |        |        |        |        |
| 端子材料 / Pin material           | 黄铜镀金 / Brass With Gold Plated          |        |        |        |        |        |        |
| 螺丝材料 / Screw                  | 黄铜镀镍 / Brass With Nickel Plated        |        |        |        |        |        |        |
| 壳体材料 / Outer shell material   | 锌合金镀镍 / Zinc Alloys With Nickel Plated |        |        |        |        |        |        |
| 胶圈材料 / Gasket material        | 氟胶圈 / Fluorine Ring                    |        |        |        |        |        |        |



## M12前锁面板式线端母头 焊线型PG9 SW17T后灌胶

产品图 / Product photo



尺寸图 / Dimension

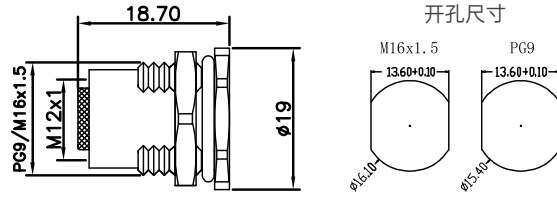

针位分布前视图 / Pin assignment front view

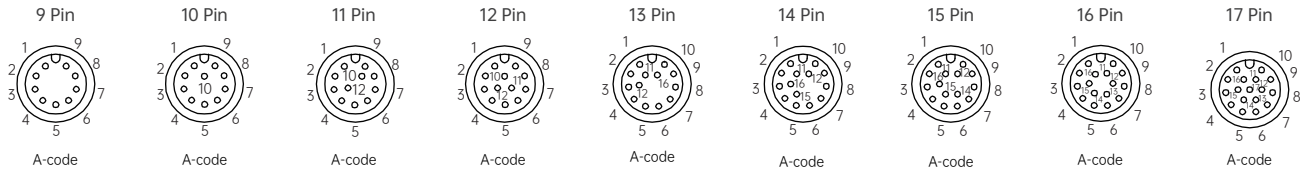

订货信息 / Order daec

| 芯数 / Number of cores | Coding | 料号 / Part number      | Qty      |
|----------------------|--------|-----------------------|----------|
| 09 Pin               | A-code | M12A09-04-092-M16/PG9 | 1000 pcs |
| 10 Pin               | A-code | M12A10-04-092-M16/PG9 | 1000 pcs |
| 11 Pin               | A-code | M12A11-04-092-M16/PG9 | 1000 pcs |
| 12 Pin               | A-code | M12A12-04-092-M16/PG9 | 1000 pcs |
| 13 Pin               | A-code | M12A13-04-092-M16/PG9 | 1000 pcs |
| 14 Pin               | A-code | M12A14-04-092-M16/PG9 | 1000 pcs |
| 15 Pin               | A-code | M12A15-04-092-M16/PG9 | 1000 pcs |
| 16 Pin               | A-code | M12A16-04-092-M16/PG9 | 1000 pcs |
| 17 Pin               | A-code | M12A17-04-092-M16/PG9 | 1000 pcs |

技术参数 / Specifications

| 芯数 / Pin                      | 09 Pin                                 | 10 Pin | 11 Pin | 12 Pin | 13 Pin | 14 Pin | 15 Pin | 16 Pin | 17 Pin |
|-------------------------------|--|--------|--------|--------|--------|--------|--------|--------|--------|
| 额定电流 / Rated current          | 1.5 A                                  |        |        |        |        |        |        |        |        |
| 额定电压 / Rated voltage          | 30 V                                   |        |        |        |        |        |        |        |        |
| 标准 / Standard                 | IEC 61076-2-101                        |        |        |        |        |        |        |        |        |
| 接线方式 / Termination            | 焊线 / Solder                            |        |        |        |        |        |        |        |        |
| 锁紧方式 / Connect locking system | 螺纹锁紧 / Screw Lock                      |        |        |        |        |        |        |        |        |
| 防护等级 / Degree of protection   | IP67 / IP68                            |        |        |        |        |        |        |        |        |
| 插拔次数 / Mechanical durability  | 500次                                   |        |        |        |        |        |        |        |        |
| 工作温度 / Operation temperature  | -25 °C ~ +85 °C                        |        |        |        |        |        |        |        |        |
| 接触电阻 / Contact resistance     | ≤ 10mΩ                                 |        |        |        |        |        |        |        |        |
| 绝缘电阻 / Insulation resistance  | ≥ 1000MΩ                               |        |        |        |        |        |        |        |        |
| 胶芯材料 / Housing material       | 尼龙PA66                                 |        |        |        |        |        |        |        |        |
| 端子材料 / Pin material           | 黄铜镀金 / Brass With Gold Plated          |        |        |        |        |        |        |        |        |
| 螺丝材料 / Screw                  | 黄铜镀镍 / Brass With Nickel Plated        |        |        |        |        |        |        |        |        |
| 壳体材料 / Outer shell material   | 锌合金镀镍 / Zinc Alloys With Nickel Plated |        |        |        |        |        |        |        |        |
| 胶圈材料 / Gasket material        | 氟胶圈 / Fluorine Ring                    |        |        |        |        |        |        |        |        |

## M12前锁面板式线端母头 焊线型M16/PG9 SW17T







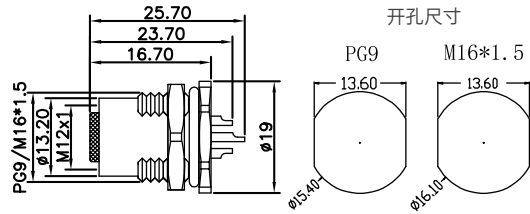







产品图 / Product photo



尺寸图 / Dimension



针位分布前视图 / Pin assignment front view

|        | 2 Pin   | 3 Pin   | 4 Pin   | 5 Pin   | 6 Pin   | 7 Pin  | 8 Pin   |
|--------|---|---|---|---|---|--|---|
| A-code |  |  |  |  |  |  |  |
| B-code |  |  |  |  |   |  |   |
| D-code |  |  |  |   |   |  |   |

订货信息 / Order daeo

| 芯数 / Number of cores | Coding | 料号 / Part number      | Qty      | 芯数 / Number of cores | Coding | 料号 / Part number      | Qty      |
|----------------------|--------|-----------------------|----------|----------------------|--------|-----------------------|----------|
| 02 Pin               | A-code | M12A02-04-096-M16/PG9 | 1000 pcs | 02 Pin               | B-code | M12B02-04-096-M16/PG9 | 1000 pcs |
| 03 Pin               | A-code | M12A03-04-096-M16/PG9 | 1000 pcs | 03 Pin               | B-code | M12B03-04-096-M16/PG9 | 1000 pcs |
| 04 Pin               | A-code | M12A04-04-096-M16/PG9 | 1000 pcs | 04 Pin               | B-code | M12B04-04-096-M16/PG9 | 1000 pcs |
| 05 Pin               | A-code | M12A05-04-096-M16/PG9 | 1000 pcs | 05 Pin               | B-code | M12B05-04-096-M16/PG9 | 1000 pcs |
| 06 Pin               | A-code | M12A06-04-096-M16/PG9 | 1000 pcs | 02 Pin               | D-code | M12D02-04-096-M16/PG9 | 1000 pcs |
| 07 Pin               | A-code | M12A07-04-096-M16/PG9 | 1000 pcs | 03 Pin               | D-code | M12D03-04-096-M16/PG9 | 1000 pcs |
| 08 Pin               | A-code | M12A08-04-096-M16/PG9 | 1000 pcs | 04 Pin               | D-code | M12D04-04-096-M16/PG9 | 1000 pcs |

技术参数 / Specifications

| 芯数 / Pin                      | 02 Pin                                 | 03 Pin | 04 Pin | 05 Pin | 06 Pin | 07 Pin | 08 Pin |
|-------------------------------|--|--------|--------|--------|--------|--------|--------|
| 额定电流 / Rated current          | 4 A                                    | 4 A    | 4 A    | 4 A    | 2 A    | 2 A    | 2 A    |
| 额定电压 / Rated voltage          | 60 V                                   | 60 V   | 60 V   | 60 V   | 30 V   | 30 V   | 30 V   |
| 标准 / Standard                 | IEC 61076-2-101                        |        |        |        |        |        |        |
| 接线方式 / Termination            | 焊线 / Solder                            |        |        |        |        |        |        |
| 锁紧方式 / Connect locking system | 螺纹锁紧 / Screw Lock                      |        |        |        |        |        |        |
| 防护等级 / Degree of protection   | IP67 / IP68                            |        |        |        |        |        |        |
| 插拔次数 / Mechanical durability  | 500次                                   |        |        |        |        |        |        |
| 工作温度 / Operation temperature  | -25 °C ~ +85 °C                        |        |        |        |        |        |        |
| 接触电阻 / Contact resistance     | ≤ 10mΩ                                 |        |        |        |        |        |        |
| 绝缘电阻 / Insulation resistance  | ≥ 1000MΩ                               |        |        |        |        |        |        |
| 胶芯材料 / Housing material       | 尼龙PA66                                 |        |        |        |        |        |        |
| 端子材料 / Pin material           | 黄铜镀金 / Brass With Gold Plated          |        |        |        |        |        |        |
| 螺丝材料 / Screw                  | 黄铜镀镍 / Brass With Nickel Plated        |        |        |        |        |        |        |
| 壳体材料 / Outer shell material   | 锌合金镀镍 / Zinc Alloys With Nickel Plated |        |        |        |        |        |        |
| 胶圈材料 / Gasket material        | 氟胶圈 / Fluorine Ring                    |        |        |        |        |        |        |

## M12前锁面板式线端母头 焊线型M16/PG9 SW17T

产品图 / Product photo



尺寸图 / Dimension

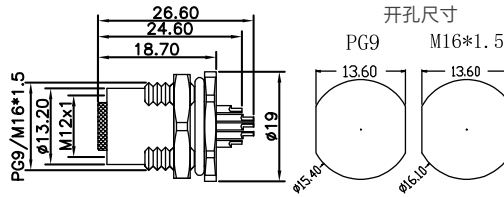

针位分布前视图 / Pin assignment front view

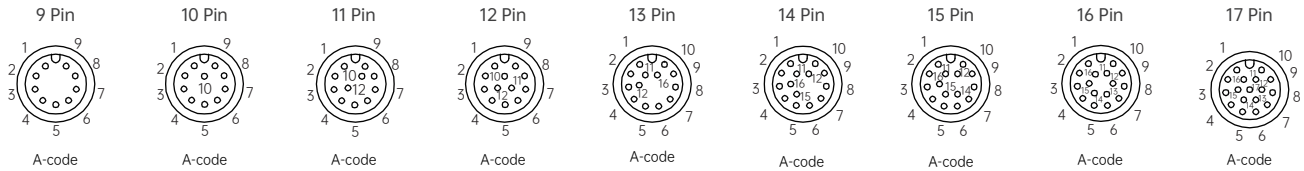

订货信息 / Order daec

| 芯数 / Number of cores | Coding | 料号 / Part number      | Qty      |
|----------------------|--------|-----------------------|----------|
| 09 Pin               | A-code | M12A09-04-097-M16/PG9 | 1000 pcs |
| 10 Pin               | A-code | M12A10-04-097-M16/PG9 | 1000 pcs |
| 11 Pin               | A-code | M12A11-04-097-M16/PG9 | 1000 pcs |
| 12 Pin               | A-code | M12A12-04-097-M16/PG9 | 1000 pcs |
| 13 Pin               | A-code | M12A13-04-097-M16/PG9 | 1000 pcs |
| 14 Pin               | A-code | M12A14-04-097-M16/PG9 | 1000 pcs |
| 15 Pin               | A-code | M12A15-04-097-M16/PG9 | 1000 pcs |
| 16 Pin               | A-code | M12A16-04-097-M16/PG9 | 1000 pcs |
| 17 Pin               | A-code | M12A17-04-097-M16/PG9 | 1000 pcs |

技术参数 / Specifications

| 芯数 / Pin                      | 09 Pin                                 | 10 Pin | 11 Pin | 12 Pin | 13 Pin | 14 Pin | 15 Pin | 16 Pin | 17 Pin |
|-------------------------------|--|--------|--------|--------|--------|--------|--------|--------|--------|
| 额定电流 / Rated current          | 1.5 A                                  |        |        |        |        |        |        |        |        |
| 额定电压 / Rated voltage          | 30 V                                   |        |        |        |        |        |        |        |        |
| 标准 / Standard                 | IEC 61076-2-101                        |        |        |        |        |        |        |        |        |
| 接线方式 / Termination            | 焊线 / Solder                            |        |        |        |        |        |        |        |        |
| 锁紧方式 / Connect locking system | 螺纹锁紧 / Screw Lock                      |        |        |        |        |        |        |        |        |
| 防护等级 / Degree of protection   | IP67 / IP68                            |        |        |        |        |        |        |        |        |
| 插拔次数 / Mechanical durability  | 500次                                   |        |        |        |        |        |        |        |        |
| 工作温度 / Operation temperature  | -25 °C ~ +85 °C                        |        |        |        |        |        |        |        |        |
| 接触电阻 / Contact resistance     | ≤ 10mΩ                                 |        |        |        |        |        |        |        |        |
| 绝缘电阻 / Insulation resistance  | ≥ 1000MΩ                               |        |        |        |        |        |        |        |        |
| 胶芯材料 / Housing material       | 尼龙PA66                                 |        |        |        |        |        |        |        |        |
| 端子材料 / Pin material           | 黄铜镀金 / Brass With Gold Plated          |        |        |        |        |        |        |        |        |
| 螺丝材料 / Screw                  | 黄铜镀镍 / Brass With Nickel Plated        |        |        |        |        |        |        |        |        |
| 壳体材料 / Outer shell material   | 锌合金镀镍 / Zinc Alloys With Nickel Plated |        |        |        |        |        |        |        |        |
| 胶圈材料 / Gasket material        | 氟胶圈 / Fluorine Ring                    |        |        |        |        |        |        |        |        |

## M12前锁面板式线端母头 焊线型M16/PG9 SW17T

产品图 / Product photo



尺寸图 / Dimension

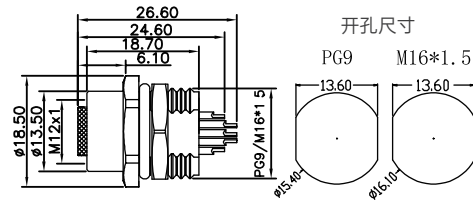

针位分布前视图 / Pin assignment front view

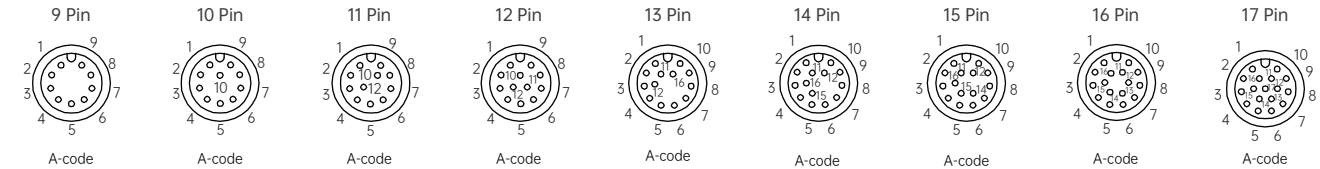

订货信息 / Order daea

| 芯数 / Number of cores | Coding | 料号 / Part number      | Qty      |
|----------------------|--------|-----------------------|----------|
| 09 Pin               | A-code | M12A09-04-099-M16/PG9 | 1000 pcs |
| 10 Pin               | A-code | M12A10-04-099-M16/PG9 | 1000 pcs |
| 11 Pin               | A-code | M12A11-04-099-M16/PG9 | 1000 pcs |
| 12 Pin               | A-code | M12A12-04-099-M16/PG9 | 1000 pcs |
| 13 Pin               | A-code | M12A13-04-099-M16/PG9 | 1000 pcs |
| 14 Pin               | A-code | M12A14-04-099-M16/PG9 | 1000 pcs |
| 15 Pin               | A-code | M12A15-04-099-M16/PG9 | 1000 pcs |
| 16 Pin               | A-code | M12A16-04-099-M16/PG9 | 1000 pcs |
| 17 Pin               | A-code | M12A17-04-099-M16/PG9 | 1000 pcs |

技术参数 / Specifications

| 芯数 / Pin                      | 09 Pin                                 | 10 Pin | 11 Pin | 12 Pin | 13 Pin | 14 Pin | 15 Pin | 16 Pin | 17 Pin |
|-------------------------------|--|--------|--------|--------|--------|--------|--------|--------|--------|
| 额定电流 / Rated current          | 1.5 A                                  |        |        |        |        |        |        |        |        |
| 额定电压 / Rated voltage          | 30 V                                   |        |        |        |        |        |        |        |        |
| 标准 / Standard                 | IEC 61076-2-101                        |        |        |        |        |        |        |        |        |
| 接线方式 / Termination            | 焊线 / Solder                            |        |        |        |        |        |        |        |        |
| 锁紧方式 / Connect locking system | 螺纹锁紧 / Screw Lock                      |        |        |        |        |        |        |        |        |
| 防护等级 / Degree of protection   | IP67 / IP68                            |        |        |        |        |        |        |        |        |
| 插拔次数 / Mechanical durability  | 500次                                   |        |        |        |        |        |        |        |        |
| 工作温度 / Operation temperature  | -25 °C ~ +85 °C                        |        |        |        |        |        |        |        |        |
| 接触电阻 / Contact resistance     | ≤ 10mΩ                                 |        |        |        |        |        |        |        |        |
| 绝缘电阻 / Insulation resistance  | ≥ 1000MΩ                               |        |        |        |        |        |        |        |        |
| 胶芯材料 / Housing material       | 尼龙PA66                                 |        |        |        |        |        |        |        |        |
| 端子材料 / Pin material           | 黄铜镀金 / Brass With Gold Plated          |        |        |        |        |        |        |        |        |
| 螺丝材料 / Screw                  | 黄铜镀镍 / Brass With Nickel Plated        |        |        |        |        |        |        |        |        |
| 壳体材料 / Outer shell material   | 锌合金镀镍 / Zinc Alloys With Nickel Plated |        |        |        |        |        |        |        |        |
| 胶圈材料 / Gasket material        | 氟胶圈 / Fluorine Ring                    |        |        |        |        |        |        |        |        |

## M12前锁面板式线端母头 焊线型M16.PG9 SW17T

产品图 / Product photo



尺寸图 / Dimension

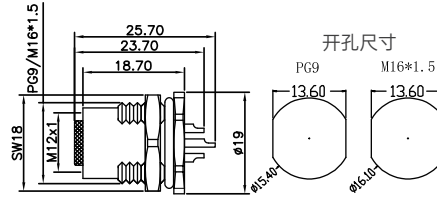

针位分布前视图 / Pin assignment front view

|        | 2 Pin | 3 Pin | 4 Pin | 5 Pin | 6 Pin | 7 Pin | 8 Pin |
|--------|-------|-------|-------|-------|-------|-------|-------|
| A-code |       |       |       |       |       |       |       |
| B-code |       |       |       |       |       |       |       |
| D-code |       |       |       |       |       |       |       |

订货信息 / Order daec

| 芯数 / Number of cores | Coding | 料号 / Part number      | Qty      | 芯数 / Number of cores | Coding | 料号 / Part number      | Qty      |
|----------------------|--------|-----------------------|----------|----------------------|--------|-----------------------|----------|
| 02 Pin               | A-code | M12A02-04-101-M16/PG9 | 1000 pcs | 02 Pin               | B-code | M12B02-04-101-M16/PG9 | 1000 pcs |
| 03 Pin               | A-code | M12A03-04-101-M16/PG9 | 1000 pcs | 03 Pin               | B-code | M12B03-04-101-M16/PG9 | 1000 pcs |
| 04 Pin               | A-code | M12A04-04-101-M16/PG9 | 1000 pcs | 04 Pin               | B-code | M12B04-04-101-M16/PG9 | 1000 pcs |
| 05 Pin               | A-code | M12A05-04-101-M16/PG9 | 1000 pcs | 05 Pin               | B-code | M12B05-04-101-M16/PG9 | 1000 pcs |
| 06 Pin               | A-code | M12A06-04-101-M16/PG9 | 1000 pcs | 02 Pin               | D-code | M12D02-04-101-M16/PG9 | 1000 pcs |
| 07 Pin               | A-code | M12A07-04-101-M16/PG9 | 1000 pcs | 03 Pin               | D-code | M12D03-04-101-M16/PG9 | 1000 pcs |
| 08 Pin               | A-code | M12A08-04-101-M16/PG9 | 1000 pcs | 04 Pin               | D-code | M12D04-04-101-M16/PG9 | 1000 pcs |

技术参数 / Specifications

| 芯数 / Pin                      | 02 Pin                                 | 03 Pin | 04 Pin | 05 Pin | 06 Pin | 07 Pin | 08 Pin |
|-------------------------------|--|--------|--------|--------|--------|--------|--------|
| 额定电流 / Rated current          | 4 A                                    | 4 A    | 4 A    | 4 A    | 2 A    | 2 A    | 2 A    |
| 额定电压 / Rated voltage          | 60 V                                   | 60 V   | 60 V   | 60 V   | 30 V   | 30 V   | 30 V   |
| 标准 / Standard                 | IEC 61076-2-101                        |        |        |        |        |        |        |
| 接线方式 / Termination            | 焊线 / Solder                            |        |        |        |        |        |        |
| 锁紧方式 / Connect locking system | 螺纹锁紧 / Screw Lock                      |        |        |        |        |        |        |
| 防护等级 / Degree of protection   | IP67 / IP68                            |        |        |        |        |        |        |
| 插拔次数 / Mechanical durability  | 500次                                   |        |        |        |        |        |        |
| 工作温度 / Operation temperature  | -25 °C ~ +85 °C                        |        |        |        |        |        |        |
| 接触电阻 / Contact resistance     | ≤ 10mΩ                                 |        |        |        |        |        |        |
| 绝缘电阻 / Insulation resistance  | ≥ 1000MΩ                               |        |        |        |        |        |        |
| 胶芯材料 / Housing material       | 尼龙PA66                                 |        |        |        |        |        |        |
| 端子材料 / Pin material           | 黄铜镀金 / Brass With Gold Plated          |        |        |        |        |        |        |
| 螺丝材料 / Screw                  | 黄铜镀镍 / Brass With Nickel Plated        |        |        |        |        |        |        |
| 壳体材料 / Outer shell material   | 锌合金镀镍 / Zinc Alloys With Nickel Plated |        |        |        |        |        |        |
| 胶圈材料 / Gasket material        | 氟胶圈 / Fluorine Ring                    |        |        |        |        |        |        |

## M12前锁面板式板端母头 焊板型M16.PG9 SW17T-24.7L

产品图 / Product photo



尺寸图 / Dimension

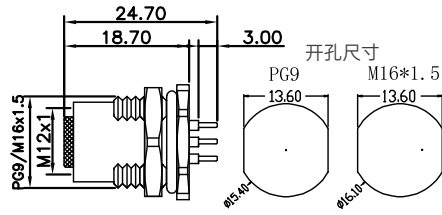

针位分布前视图 / Pin assignment front view

|        | 2 Pin | 3 Pin | 4 Pin | 5 Pin | 6 Pin | 7 Pin | 8 Pin |
|--------|-------|-------|-------|-------|-------|-------|-------|
| A-code |       |       |       |       |       |       |       |
| B-code |       |       |       |       |       |       |       |
| D-code |       |       |       |       |       |       |       |

订货信息 / Order daec

| 芯数 / Number of cores | Coding | 料号 / Part number      | Qty      | 芯数 / Number of cores | Coding | 料号 / Part number      | Qty      |
|----------------------|--------|-----------------------|----------|----------------------|--------|-----------------------|----------|
| 02 Pin               | A-code | M12A02-04-089-M16/PG9 | 1000 pcs | 02 Pin               | B-code | M12B02-04-089-M16/PG9 | 1000 pcs |
| 03 Pin               | A-code | M12A03-04-089-M16/PG9 | 1000 pcs | 03 Pin               | B-code | M12B03-04-089-M16/PG9 | 1000 pcs |
| 04 Pin               | A-code | M12A04-04-089-M16/PG9 | 1000 pcs | 04 Pin               | B-code | M12B04-04-089-M16/PG9 | 1000 pcs |
| 05 Pin               | A-code | M12A05-04-089-M16/PG9 | 1000 pcs | 05 Pin               | B-code | M12B05-04-089-M16/PG9 | 1000 pcs |
| 06 Pin               | A-code | M12A06-04-089-M16/PG9 | 1000 pcs | 02 Pin               | D-code | M12D02-04-089-M16/PG9 | 1000 pcs |
| 07 Pin               | A-code | M12A07-04-089-M16/PG9 | 1000 pcs | 03 Pin               | D-code | M12D03-04-089-M16/PG9 | 1000 pcs |
| 08 Pin               | A-code | M12A08-04-089-M16/PG9 | 1000 pcs | 04 Pin               | D-code | M12D04-04-089-M16/PG9 | 1000 pcs |

技术参数 / Specifications

| 芯数 / Pin                      | 02 Pin                          | 03 Pin | 04 Pin | 05 Pin | 06 Pin | 07 Pin | 08 Pin |
|-------------------------------|---------------------------------|--------|--------|--------|--------|--------|--------|
| 额定电流 / Rated current          | 4 A                             | 4 A    | 4 A    | 4 A    | 2 A    | 2 A    | 2 A    |
| 额定电压 / Rated voltage          | 60 V                            | 60 V   | 60 V   | 60 V   | 30 V   | 30 V   | 30 V   |
| 标准 / Standard                 | IEC 61076-2-101                 |        |        |        |        |        |        |
| 接线方式 / Termination            | 浸焊 / Dip-Solder                 |        |        |        |        |        |        |
| 锁紧方式 / Connect locking system | 螺纹锁紧 / Screw Lock               |        |        |        |        |        |        |
| 防护等级 / Degree of protection   | IP67 / IP68                     |        |        |        |        |        |        |
| 插拔次数 / Mechanical durability  | 500次                            |        |        |        |        |        |        |
| 工作温度 / Operation temperature  | -25 °C ~ +85 °C                 |        |        |        |        |        |        |
| 接触电阻 / Contact resistance     | ≤ 10mΩ                          |        |        |        |        |        |        |
| 绝缘电阻 / Insulation resistance  | ≥ 1000MΩ                        |        |        |        |        |        |        |
| 胶芯材料 / Housing material       | 尼龙PA66                          |        |        |        |        |        |        |
| 端子材料 / Pin material           | 黄铜镀金 / Brass With Gold Plated   |        |        |        |        |        |        |
| 螺丝材料 / Screw                  | 黄铜镀镍 / Brass With Nickel Plated |        |        |        |        |        |        |
| 壳体材料 / Outer shell material   | 黄铜镀镍 / Brass With Nickel Plated |        |        |        |        |        |        |
| 胶圈材料 / Gasket material        | 氟胶圈 / Fluorine Ring             |        |        |        |        |        |        |

## M12前锁面板式8P板端母头X编码 焊板型PG9 SW17T

产品图 / Product photo



尺寸图 / Dimension

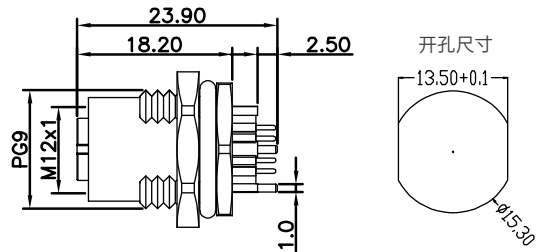

针位分布前视图 / Pin assignment front view



订货信息 / Order daea

| 芯数 / Number of cores | Coding | 料号 / Part number | Qty      |
|----------------------|--------|------------------|----------|
| 08 Pin               | X-code | M12X08-04-110    | 1000 pcs |

技术参数 / Specifications

| 芯数 / Pin                        | 08 Pin                                 |
|---------------------------------|--|
| 额定电流 / Rated current            | 0.5 A                                  |
| 额定电压 / Rated voltage            | 48 V                                   |
| 标准 / Standard                   | IEC 61076-2-101                        |
| 接线方式 / Termination              | 浸焊 / Dip-Solder                        |
| 锁紧方式 / Connect locking system   | 螺纹锁紧 / Screw Lock                      |
| 防护等级 / Degree of protection     | IP67 / IP68                            |
| 插拔次数 / Mechanical durability    | 500次                                   |
| 工作温度 / Operation temperature    | -25 °C ~ +85 °C                        |
| 接触电阻 / Contact resistance       | ≤ 10mΩ                                 |
| 绝缘电阻 / Insulation resistance    | > 1000MΩ                               |
| 胶芯材料 / Housing material         | 尼龙PA66                                 |
| 端子材料 / Pin material             | 黄铜镀金 / Brass With Gold Plated          |
| 螺丝材料 / Screw                    | 锌合金镀镍 / Zinc Alloys With Nickel Plated |
| 胶圈材料 / Gasket material          | 氟胶圈 / Fluorine Ring                    |
| 屏蔽罩材料 / Shielded shell material | 锌合金镀镍 / Zinc Alloys With Nickel Plated |

## M12前锁面板式板端母头 焊板型M16.PG9 SW17T-24.7L+地

产品图 / Product photo



尺寸图 / Dimension

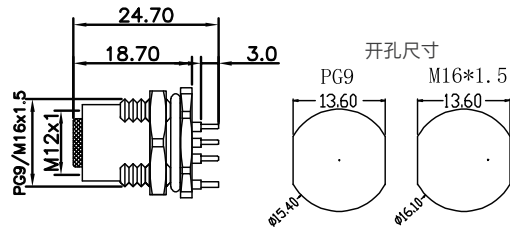

针位分布前视图 / Pin assignment front view

|        | 2 Pin | 3 Pin | 4 Pin | 5 Pin | 6 Pin | 7 Pin | 8 Pin |
|--------|-------|-------|-------|-------|-------|-------|-------|
| A-code |       |       |       |       |       |       |       |
| B-code |       |       |       |       |       |       |       |
| D-code |       |       |       |       |       |       |       |

订货信息 / Order daec

| 芯数 / Number of cores | Coding | 料号 / Part number      | Qty      | 芯数 / Number of cores | Coding | 料号 / Part number      | Qty      |
|----------------------|--------|-----------------------|----------|----------------------|--------|-----------------------|----------|
| 02 Pin               | A-code | M12A02-04-090-M16/PG9 | 1000 pcs | 02 Pin               | B-code | M12B02-04-090-M16/PG9 | 1000 pcs |
| 03 Pin               | A-code | M12A03-04-090-M16/PG9 | 1000 pcs | 03 Pin               | B-code | M12B03-04-090-M16/PG9 | 1000 pcs |
| 04 Pin               | A-code | M12A04-04-090-M16/PG9 | 1000 pcs | 04 Pin               | B-code | M12B04-04-090-M16/PG9 | 1000 pcs |
| 05 Pin               | A-code | M12A05-04-090-M16/PG9 | 1000 pcs | 05 Pin               | B-code | M12B05-04-090-M16/PG9 | 1000 pcs |
| 06 Pin               | A-code | M12A06-04-090-M16/PG9 | 1000 pcs | 02 Pin               | D-code | M12D02-04-090-M16/PG9 | 1000 pcs |
| 07 Pin               | A-code | M12A07-04-090-M16/PG9 | 1000 pcs | 03 Pin               | D-code | M12D03-04-090-M16/PG9 | 1000 pcs |
| 08 Pin               | A-code | M12A08-04-090-M16/PG9 | 1000 pcs | 04 Pin               | D-code | M12D04-04-090-M16/PG9 | 1000 pcs |

技术参数 / Specifications

| 芯数 / Pin                      | 02 Pin                          | 03 Pin | 04 Pin | 05 Pin | 06 Pin | 07 Pin | 08 Pin |
|-------------------------------|---------------------------------|--------|--------|--------|--------|--------|--------|
| 额定电流 / Rated current          | 4 A                             | 4 A    | 4 A    | 4 A    | 2 A    | 2 A    | 2 A    |
| 额定电压 / Rated voltage          | 60 V                            | 60 V   | 60 V   | 60 V   | 30 V   | 30 V   | 30 V   |
| 标准 / Standard                 | IEC 61076-2-101                 |        |        |        |        |        |        |
| 接线方式 / Termination            | 浸焊 / Dip-Solder                 |        |        |        |        |        |        |
| 锁紧方式 / Connect locking system | 螺纹锁紧 / Screw Lock               |        |        |        |        |        |        |
| 防护等级 / Degree of protection   | IP67 / IP68                     |        |        |        |        |        |        |
| 插拔次数 / Mechanical durability  | 500次                            |        |        |        |        |        |        |
| 工作温度 / Operation temperature  | -25 °C ~ +85 °C                 |        |        |        |        |        |        |
| 接触电阻 / Contact resistance     | ≤ 10mΩ                          |        |        |        |        |        |        |
| 绝缘电阻 / Insulation resistance  | ≥ 1000MΩ                        |        |        |        |        |        |        |
| 胶芯材料 / Housing material       | 尼龙PA66                          |        |        |        |        |        |        |
| 端子材料 / Pin material           | 黄铜镀金 / Brass With Gold Plated   |        |        |        |        |        |        |
| 螺丝材料 / Screw                  | 黄铜镀镍 / Brass With Nickel Plated |        |        |        |        |        |        |
| 壳体材料 / Outer shell material   | 黄铜镀镍 / Brass With Nickel Plated |        |        |        |        |        |        |
| 胶圈材料 / Gasket material        | 氟胶圈 / Fluorine Ring             |        |        |        |        |        |        |



## M12前锁面板式板端母弯头 焊板型

产品图 / Product photo



尺寸图 / Dimension

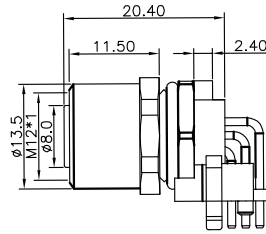

针位分布前视图 / Pin assignment front view

|        | 2 Pin | 3 Pin | 4 Pin | 5 Pin | 6 Pin | 7 Pin | 8 Pin |
|--------|-------|-------|-------|-------|-------|-------|-------|
| A-code |       |       |       |       |       |       |       |
| B-code |       |       |       |       |       |       |       |
| D-code |       |       |       |       |       |       |       |

订货信息 / Order daec

| 芯数 / Number of cores | Coding | 料号 / Part number | Qty      |
|----------------------|--------|------------------|----------|
| 02 Pin               | A-code | M12A02-04-100    | 1000 pcs |
| 03 Pin               | A-code | M12A03-04-100    | 1000 pcs |
| 04 Pin               | A-code | M12A04-04-100    | 1000 pcs |
| 05 Pin               | A-code | M12A05-04-100    | 1000 pcs |
| 06 Pin               | A-code | M12A06-04-100    | 1000 pcs |
| 07 Pin               | A-code | M12A07-04-100    | 1000 pcs |
| 08 Pin               | A-code | M12A08-04-100    | 1000 pcs |
| 05 Pin               | B-code | M12B05-04-100    | 1000 pcs |
| 04 Pin               | D-code | M12D04-04-100    | 1000 pcs |

技术参数 / Specifications

| 芯数 / Pin                      | 02 Pin                          | 03 Pin | 04 Pin | 05 Pin | 06 Pin | 07 Pin | 08 Pin |
|-------------------------------|---------------------------------|--------|--------|--------|--------|--------|--------|
| 额定电流 / Rated current          | 4 A                             | 4 A    | 4 A    | 4 A    | 2 A    | 2 A    | 2 A    |
| 额定电压 / Rated voltage          | 250 V                           | 250 V  | 250 V  | 60 V   | 30 V   | 30 V   | 30 V   |
| 标准 / Standard                 | IEC 61076-2-101                 |        |        |        |        |        |        |
| 接线方式 / Termination            | PCB                             |        |        |        |        |        |        |
| 锁紧方式 / Connect locking system | 螺纹锁紧 / Screw Lock               |        |        |        |        |        |        |
| 防护等级 / Degree of protection   | IP67 / IP68                     |        |        |        |        |        |        |
| 插拔次数 / Mechanical durability  | 500次                            |        |        |        |        |        |        |
| 工作温度 / Operation temperature  | -25 °C ~ +85 °C                 |        |        |        |        |        |        |
| 接触电阻 / Contact resistance     | ≤ 10mΩ                          |        |        |        |        |        |        |
| 绝缘电阻 / Insulation resistance  | ≥ 1000MΩ                        |        |        |        |        |        |        |
| 胶芯材料 / Housing material       | 尼龙PA66                          |        |        |        |        |        |        |
| 端子材料 / Pin material           | 黄铜镀金 / Brass With Gold Plated   |        |        |        |        |        |        |
| 螺丝材料 / Screw material         | 黄铜镀镍 / Brass With Nickel Plated |        |        |        |        |        |        |
| 壳体材料 / Outer shell material   | 黄铜镀镍 / Brass With Nickel Plated |        |        |        |        |        |        |
| 胶圈材料 / Gasket material        | 氟胶圈 / Fluorine Ring             |        |        |        |        |        |        |

## M12后锁面板式线端公头 焊线型M12 F15T

产品图 / Product photo



尺寸图 / Dimension

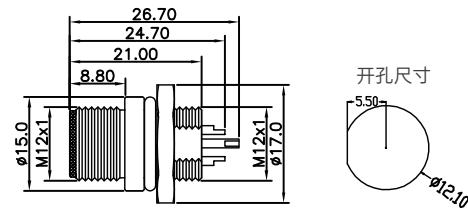

针位分布前视图 / Pin assignment front view

|        | 2 Pin | 3 Pin | 4 Pin | 5 Pin | 6 Pin | 7 Pin | 8 Pin |
|--------|-------|-------|-------|-------|-------|-------|-------|
| A-code |       |       |       |       |       |       |       |
| B-code |       |       |       |       |       |       |       |
| D-code |       |       |       |       |       |       |       |

订货信息 / Order daec

| 芯数 / Number of cores | Coding | 料号 / Part number | Qty      | 芯数 / Number of cores | Coding | 料号 / Part number | Qty      |
|----------------------|--------|------------------|----------|----------------------|--------|------------------|----------|
| 02 Pin               | A-code | M12A02-03-115    | 1000 pcs | 02 Pin               | B-code | M12B02-03-115    | 1000 pcs |
| 03 Pin               | A-code | M12A03-03-115    | 1000 pcs | 03 Pin               | B-code | M12B03-03-115    | 1000 pcs |
| 04 Pin               | A-code | M12A04-03-115    | 1000 pcs | 04 Pin               | B-code | M12B04-03-115    | 1000 pcs |
| 05 Pin               | A-code | M12A05-03-115    | 1000 pcs | 05 Pin               | B-code | M12B05-03-115    | 1000 pcs |
| 06 Pin               | A-code | M12A06-03-115    | 1000 pcs | 02 Pin               | D-code | M12D02-03-115    | 1000 pcs |
| 07 Pin               | A-code | M12A07-03-115    | 1000 pcs | 03 Pin               | D-code | M12D03-03-115    | 1000 pcs |
| 08 Pin               | A-code | M12A08-03-115    | 1000 pcs | 04 Pin               | D-code | M12D04-03-115    | 1000 pcs |

技术参数 / Specifications

| 芯数 / Pin                      | 02 Pin                          | 03 Pin | 04 Pin | 05 Pin | 06 Pin | 07 Pin | 08 Pin |
|-------------------------------|---------------------------------|--------|--------|--------|--------|--------|--------|
| 额定电流 / Rated current          | 4 A                             | 4 A    | 4 A    | 4 A    | 2 A    | 2 A    | 2 A    |
| 额定电压 / Rated voltage          | 60 V                            | 60 V   | 60 V   | 60 V   | 30 V   | 30 V   | 30 V   |
| 标准 / Standard                 | IEC 61076-2-101                 |        |        |        |        |        |        |
| 接线方式 / Termination            | 焊线 / Solder                     |        |        |        |        |        |        |
| 锁紧方式 / Connect locking system | 螺纹锁紧 / Screw Lock               |        |        |        |        |        |        |
| 防护等级 / Degree of protection   | IP67 / IP68                     |        |        |        |        |        |        |
| 插拔次数 / Mechanical durability  | 500次                            |        |        |        |        |        |        |
| 工作温度 / Operation temperature  | -25 °C ~ +85 °C                 |        |        |        |        |        |        |
| 接触电阻 / Contact resistance     | ≤ 10mΩ                          |        |        |        |        |        |        |
| 绝缘电阻 / Insulation resistance  | ≥ 1000MΩ                        |        |        |        |        |        |        |
| 胶芯材料 / Housing material       | 尼龙PA66                          |        |        |        |        |        |        |
| 端子材料 / Pin material           | 黄铜镀金 / Brass With Gold Plated   |        |        |        |        |        |        |
| 螺丝材料 / Screw                  | 黄铜镀镍 / Brass With Nickel Plated |        |        |        |        |        |        |
| 壳体材料 / Outer shell material   | 黄铜镀镍 / Brass With Nickel Plated |        |        |        |        |        |        |
| 胶圈材料 / Gasket material        | 氟胶圈 / Fluorine Ring             |        |        |        |        |        |        |

## M12后锁面板式线端公头 焊线型M12 F15T

产品图 / Product photo



尺寸图 / Dimension

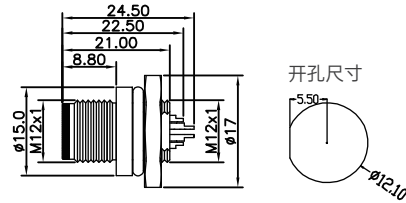

针位分布前视图 / Pin assignment front view

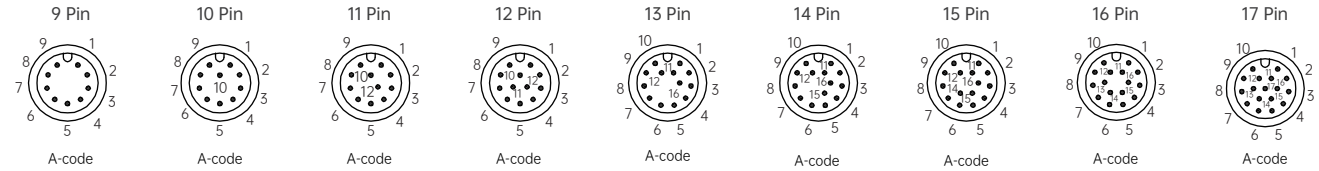

订货信息 / Order daec

| 芯数 / Number of cores | Coding | 料号 / Part number | Qty      |
|----------------------|--------|------------------|----------|
| 09 Pin               | A-code | M12A09-03-120    | 1000 pcs |
| 10 Pin               | A-code | M12A10-03-120    | 1000 pcs |
| 11 Pin               | A-code | M12A11-03-120    | 1000 pcs |
| 12 Pin               | A-code | M12A12-03-120    | 1000 pcs |
| 13 Pin               | A-code | M12A13-03-120    | 1000 pcs |
| 14 Pin               | A-code | M12A14-03-120    | 1000 pcs |
| 15 Pin               | A-code | M12A15-03-120    | 1000 pcs |
| 16 Pin               | A-code | M12A16-03-120    | 1000 pcs |
| 17 Pin               | A-code | M12A17-03-120    | 1000 pcs |

技术参数 / Specifications

| 芯数 / Pin   | 09 Pin                                    | 10 Pin | 11 Pin | 12 Pin | 13 Pin | 14 Pin | 15 Pin | 16 Pin | 17 Pin |
|--|---|--------|--------|--------|--------|--------|--------|--------|--------|
| 额定电流 / Rated current                                 | 1.5 A                                     |        |        |        |        |        |        |        |        |
| 额定电压 / Rated voltage                                 | 30 V                                      |        |        |        |        |        |        |        |        |
| 线规 (mm <sup>2</sup> ) / Wire gauge(mm <sup>2</sup> ) | 0.14mm <sup>2</sup> ~ 0.75mm <sup>2</sup> |        |        |        |        |        |        |        |        |
| 线号 (AWG) / Wire gauge(AWG)                           | 26AWG ~ 18AWG                             |        |        |        |        |        |        |        |        |
| 标准 / Standard  | IEC 61076-2-101                           |        |        |        |        |        |        |        |        |
| 接线方式 / Termination                                   | 焊线 / Solder                               |        |        |        |        |        |        |        |        |
| 锁紧方式 / Connect locking system                        | 螺纹锁紧 / Screw Lock                         |        |        |        |        |        |        |        |        |
| 防护等级 / Degree of protection                          | IP67 / IP68                               |        |        |        |        |        |        |        |        |
| 插拔次数 / Mechanical durability                         | 500次                                      |        |        |        |        |        |        |        |        |
| 工作温度 / Operation temperature                         | -25 °C ~ +85 °C                           |        |        |        |        |        |        |        |        |
| 接触电阻 / Contact resistance                            | ≤ 10mΩ                                    |        |        |        |        |        |        |        |        |
| 绝缘电阻 / Insulation resistance                         | ≥ 1000MΩ                                  |        |        |        |        |        |        |        |        |
| 胶芯材料 / Housing material                              | 尼龙PA66                                    |        |        |        |        |        |        |        |        |
| 端子材料 / Pin material                                  | 黄铜镀金 / Brass With Gold Plated             |        |        |        |        |        |        |        |        |
| 螺丝材料 / Screw   | POM                                       |        |        |        |        |        |        |        |        |

## M12后锁面板式线端公头 焊线型M16/PG9 SW18T 锌合金

产品图 / Product photo



尺寸图 / Dimension

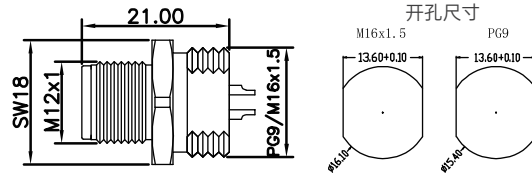

针位分布前视图 / Pin assignment front view

|        | 2 Pin | 3 Pin | 4 Pin | 5 Pin | 6 Pin | 7 Pin | 8 Pin |
|--------|-------|-------|-------|-------|-------|-------|-------|
| A-code |       |       |       |       |       |       |       |
| B-code |       |       |       |       |       |       |       |
| D-code |       |       |       |       |       |       |       |

订货信息 / Order daec

| 芯数 / Number of cores | Coding | 料号 / Part number      | Qty      | 芯数 / Number of cores | Coding | 料号 / Part number      | Qty      |
|----------------------|--------|-----------------------|----------|----------------------|--------|-----------------------|----------|
| 02 Pin               | A-code | M12A02-03-096-M16/PG9 | 1000 pcs | 02 Pin               | B-code | M12B02-03-096-M16/PG9 | 1000 pcs |
| 03 Pin               | A-code | M12A03-03-096-M16/PG9 | 1000 pcs | 03 Pin               | B-code | M12B03-03-096-M16/PG9 | 1000 pcs |
| 04 Pin               | A-code | M12A04-03-096-M16/PG9 | 1000 pcs | 04 Pin               | B-code | M12B04-03-096-M16/PG9 | 1000 pcs |
| 05 Pin               | A-code | M12A05-03-096-M16/PG9 | 1000 pcs | 05 Pin               | B-code | M12B05-03-096-M16/PG9 | 1000 pcs |
| 06 Pin               | A-code | M12A06-03-096-M16/PG9 | 1000 pcs | 02 Pin               | D-code | M12D02-03-096-M16/PG9 | 1000 pcs |
| 07 Pin               | A-code | M12A07-03-096-M16/PG9 | 1000 pcs | 03 Pin               | D-code | M12D03-03-096-M16/PG9 | 1000 pcs |
| 08 Pin               | A-code | M12A08-03-096-M16/PG9 | 1000 pcs | 04 Pin               | D-code | M12D04-03-096-M16/PG9 | 1000 pcs |

技术参数 / Specifications

| 芯数 / Pin                      | 02 Pin                                 | 03 Pin | 04 Pin | 05 Pin | 06 Pin | 07 Pin | 08 Pin |
|-------------------------------|--|--------|--------|--------|--------|--------|--------|
| 额定电流 / Rated current          | 4 A                                    | 4 A    | 4 A    | 4 A    | 2 A    | 2 A    | 2 A    |
| 额定电压 / Rated voltage          | 60 V                                   | 60 V   | 60 V   | 60 V   | 30 V   | 30 V   | 30 V   |
| 标准 / Standard                 | IEC 61076-2-101                        |        |        |        |        |        |        |
| 接线方式 / Termination            | 焊线 / Solder                            |        |        |        |        |        |        |
| 锁紧方式 / Connect locking system | 螺纹锁紧 / Screw Lock                      |        |        |        |        |        |        |
| 防护等级 / Degree of protection   | IP67 / IP68                            |        |        |        |        |        |        |
| 插拔次数 / Mechanical durability  | 500次                                   |        |        |        |        |        |        |
| 工作温度 / Operation temperature  | -25 °C ~ +85 °C                        |        |        |        |        |        |        |
| 接触电阻 / Contact resistance     | ≤ 10mΩ                                 |        |        |        |        |        |        |
| 绝缘电阻 / Insulation resistance  | ≥ 1000MΩ                               |        |        |        |        |        |        |
| 胶芯材料 / Housing material       | 尼龙PA66                                 |        |        |        |        |        |        |
| 端子材料 / Pin material           | 黄铜镀金 / Brass With Gold Plated          |        |        |        |        |        |        |
| 螺丝材料 / Screw                  | 黄铜镀镍 / Brass With Nickel Plated        |        |        |        |        |        |        |
| 壳体材料 / Outer shell material   | 锌合金镀镍 / Zinc Alloys With Nickel Plated |        |        |        |        |        |        |
| 胶圈材料 / Gasket material        | 氟胶圈 / Fluorine Ring                    |        |        |        |        |        |        |

## M12后锁面板式线端公头 焊线型M12 SW15F

产品图 / Product photo



尺寸图 / Dimension

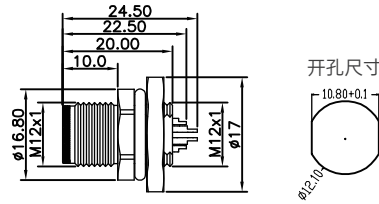

针位分布前视图 / Pin assignment front view

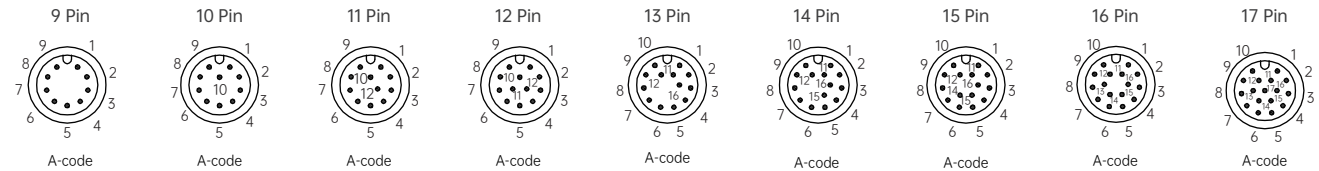

订货信息 / Order daec

| 芯数 / Number of cores | Coding | 料号 / Part number | Qty      |
|----------------------|--------|------------------|----------|
| 09 Pin               | A-code | M12A09-03-118    | 1000 pcs |
| 10 Pin               | A-code | M12A10-03-118    | 1000 pcs |
| 11 Pin               | A-code | M12A11-03-118    | 1000 pcs |
| 12 Pin               | A-code | M12A12-03-118    | 1000 pcs |
| 13 Pin               | A-code | M12A13-03-118    | 1000 pcs |
| 14 Pin               | A-code | M12A14-03-118    | 1000 pcs |
| 15 Pin               | A-code | M12A15-03-118    | 1000 pcs |
| 16 Pin               | A-code | M12A16-03-118    | 1000 pcs |
| 17 Pin               | A-code | M12A17-03-118    | 1000 pcs |

技术参数 / Specifications

| 芯数 / Pin   | 09 Pin                                    | 10 Pin | 11 Pin | 12 Pin | 13 Pin | 14 Pin | 15 Pin | 16 Pin | 17 Pin |
|--|---|--------|--------|--------|--------|--------|--------|--------|--------|
| 额定电流 / Rated Current                                 | 1.5 A                                     |        |        |        |        |        |        |        |        |
| 额定电压 / Rated voltage                                 | 30 V                                      |        |        |        |        |        |        |        |        |
| 线规 (mm <sup>2</sup> ) / Wire gauge(mm <sup>2</sup> ) | 0.14mm <sup>2</sup> ~ 0.75mm <sup>2</sup> |        |        |        |        |        |        |        |        |
| 线号 (AWG) / Wire gauge(AWG)                           | 26AWG ~ 18AWG                             |        |        |        |        |        |        |        |        |
| 标准 / Standard  | IEC 61076-2-101                           |        |        |        |        |        |        |        |        |
| 接线方式 / Termination                                   | 焊线 / Solder                               |        |        |        |        |        |        |        |        |
| 锁紧方式 / Connect Locking System                        | 螺纹锁紧 / Screw Lock                         |        |        |        |        |        |        |        |        |
| 防护等级 / Degree of Protection                          | IP67 / IP68                               |        |        |        |        |        |        |        |        |
| 插拔次数 / Mechanical durability                         | 500次                                      |        |        |        |        |        |        |        |        |
| 工作温度 / Operation Temperature                         | -25 °C ~ +85 °C                           |        |        |        |        |        |        |        |        |
| 接触电阻 / Contact Resistance                            | ≤ 10mΩ                                    |        |        |        |        |        |        |        |        |
| 绝缘电阻 / Insulation Resistance                         | ≥ 1000MΩ                                  |        |        |        |        |        |        |        |        |
| 胶芯材料 / Housing material                              | 尼龙PA66                                    |        |        |        |        |        |        |        |        |
| 端子材料 / Pin Material                                  | 黄铜镀金 / Brass With Gold Plated             |        |        |        |        |        |        |        |        |
| 螺丝材料 / Screw   | POM                                       |        |        |        |        |        |        |        |        |

## M12后锁面板式线端公头 焊线型M12 SW15T

产品图 / Product photo



尺寸图 / Dimension

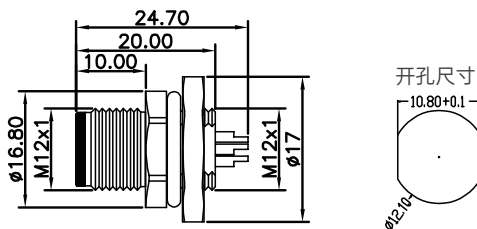

针位分布前视图 / Pin assignment front view

|        | 2 Pin | 3 Pin | 4 Pin | 5 Pin | 6 Pin | 7 Pin | 8 Pin |
|--------|-------|-------|-------|-------|-------|-------|-------|
| A-code |       |       |       |       |       |       |       |
| B-code |       |       |       |       |       |       |       |
| D-code |       |       |       |       |       |       |       |

订货信息 / Order daec

| 芯数 / Number of cores | Coding | 料号 / Part number | Qty      | 芯数 / Number of cores | Coding | 料号 / Part number | Qty      |
|----------------------|--------|------------------|----------|----------------------|--------|------------------|----------|
| 02 Pin               | A-code | M12A02-03-117    | 1000 pcs | 02 Pin               | B-code | M12B02-03-117    | 1000 pcs |
| 03 Pin               | A-code | M12A03-03-117    | 1000 pcs | 03 Pin               | B-code | M12B03-03-117    | 1000 pcs |
| 04 Pin               | A-code | M12A04-03-117    | 1000 pcs | 04 Pin               | B-code | M12B04-03-117    | 1000 pcs |
| 05 Pin               | A-code | M12A05-03-117    | 1000 pcs | 05 Pin               | B-code | M12B05-03-117    | 1000 pcs |
| 06 Pin               | A-code | M12A06-03-117    | 1000 pcs | 02 Pin               | D-code | M12D02-03-117    | 1000 pcs |
| 07 Pin               | A-code | M12A07-03-117    | 1000 pcs | 03 Pin               | D-code | M12D03-03-117    | 1000 pcs |
| 08 Pin               | A-code | M12A08-03-117    | 1000 pcs | 04 Pin               | D-code | M12D04-03-117    | 1000 pcs |

技术参数 / Specifications

| 芯数 / Pin                      | 02 Pin                          | 03 Pin | 04 Pin | 05 Pin | 06 Pin | 07 Pin | 08 Pin |
|-------------------------------|---------------------------------|--------|--------|--------|--------|--------|--------|
| 额定电流 / Rated current          | 4 A                             | 4 A    | 4 A    | 4 A    | 2 A    | 2 A    | 2 A    |
| 额定电压 / Rated voltage          | 60 V                            | 60 V   | 60 V   | 60 V   | 30 V   | 30 V   | 30 V   |
| 标准 / Standard                 | IEC 61076-2-101                 |        |        |        |        |        |        |
| 接线方式 / Termination            | 焊线 / Solder                     |        |        |        |        |        |        |
| 锁紧方式 / Connect locking system | 螺纹锁紧 / Screw Lock               |        |        |        |        |        |        |
| 防护等级 / Degree of protection   | IP67 / IP68                     |        |        |        |        |        |        |
| 插拔次数 / Mechanical durability  | 500次                            |        |        |        |        |        |        |
| 工作温度 / Operation temperature  | -25 °C ~ +85 °C                 |        |        |        |        |        |        |
| 接触电阻 / Contact resistance     | ≤ 10mΩ                          |        |        |        |        |        |        |
| 绝缘电阻 / Insulation resistance  | ≥ 1000MΩ                        |        |        |        |        |        |        |
| 胶芯材料 / Housing material       | 尼龙PA66                          |        |        |        |        |        |        |
| 端子材料 / Pin material           | 黄铜镀金 / Brass With Gold Plated   |        |        |        |        |        |        |
| 螺丝材料 / Screw                  | 黄铜镀镍 / Brass With Nickel Plated |        |        |        |        |        |        |
| 壳体材料 / Outer shell material   | 黄铜镀镍 / Brass With Nickel Plated |        |        |        |        |        |        |
| 胶圈材料 / Gasket material        | 氟胶圈 / Fluorine Ring             |        |        |        |        |        |        |

## M12后锁面板式线端公头 焊线型M12 F16.8

产品图 / Product photo



尺寸图 / Dimension

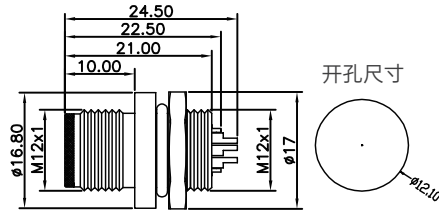

针位分布前视图 / Pin assignment front view

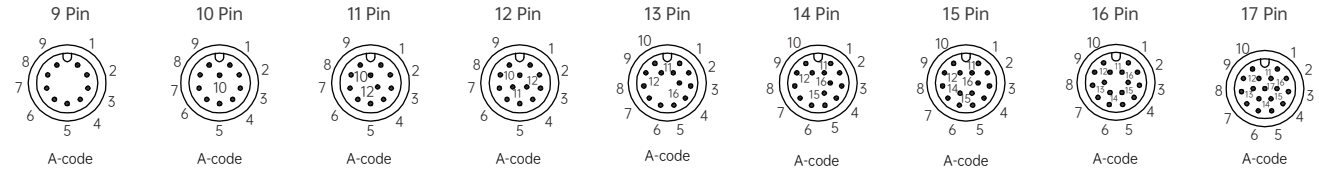

订货信息 / Order daec

| 芯数 / Number of cores | Coding | 料号 / Part number | Qty      |
|----------------------|--------|------------------|----------|
| 09 Pin               | A-code | M12A09-03-121    | 1000 pcs |
| 10 Pin               | A-code | M12A10-03-121    | 1000 pcs |
| 11 Pin               | A-code | M12A11-03-121    | 1000 pcs |
| 12 Pin               | A-code | M12A12-03-121    | 1000 pcs |
| 13 Pin               | A-code | M12A13-03-121    | 1000 pcs |
| 14 Pin               | A-code | M12A14-03-121    | 1000 pcs |
| 15 Pin               | A-code | M12A15-03-121    | 1000 pcs |
| 16 Pin               | A-code | M12A16-03-121    | 1000 pcs |
| 17 Pin               | A-code | M12A17-03-121    | 1000 pcs |

技术参数 / Specifications

| 芯数 / Pin   | 09 Pin                                    | 10 Pin | 11 Pin | 12 Pin | 13 Pin | 14 Pin | 15 Pin | 16 Pin | 17 Pin |
|--|---|--------|--------|--------|--------|--------|--------|--------|--------|
| 额定电流 / Rated current                                 | 1.5 A                                     |        |        |        |        |        |        |        |        |
| 额定电压 / Rated voltage                                 | 30 V                                      |        |        |        |        |        |        |        |        |
| 线规 (mm <sup>2</sup> ) / Wire gauge(mm <sup>2</sup> ) | 0.14mm <sup>2</sup> ~ 0.75mm <sup>2</sup> |        |        |        |        |        |        |        |        |
| 线号 (AWG) / Wire gauge(AWG)                           | 26AWG ~ 18AWG                             |        |        |        |        |        |        |        |        |
| 标准 / Standard  | IEC 61076-2-101                           |        |        |        |        |        |        |        |        |
| 接线方式 / Termination                                   | 焊线 / Solder                               |        |        |        |        |        |        |        |        |
| 锁紧方式 / Connect locking system                        | 螺纹锁紧 / Screw Lock                         |        |        |        |        |        |        |        |        |
| 防护等级 / Degree of protection                          | IP67 / IP68                               |        |        |        |        |        |        |        |        |
| 插拔次数 / Mechanical durability                         | 500次                                      |        |        |        |        |        |        |        |        |
| 工作温度 / Operation temperature                         | -25 °C ~ +85 °C                           |        |        |        |        |        |        |        |        |
| 接触电阻 / Contact resistance                            | ≤ 10mΩ                                    |        |        |        |        |        |        |        |        |
| 绝缘电阻 / Insulation resistance                         | ≥ 1000MΩ                                  |        |        |        |        |        |        |        |        |
| 胶芯材料 / Housing material                              | 尼龙PA66                                    |        |        |        |        |        |        |        |        |
| 端子材料 / Pin material                                  | 黄铜镀金 / Brass With Gold Plated             |        |        |        |        |        |        |        |        |
| 螺丝材料 / Screw   | POM                                       |        |        |        |        |        |        |        |        |

## M12后锁面板式线端公头 焊线型M12 F16.8

产品图 / Product photo



尺寸图 / Dimension

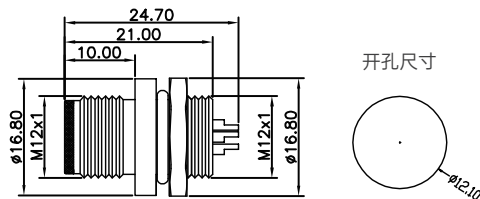

针位分布前视图 / Pin assignment front view

|        | 2 Pin | 3 Pin | 4 Pin | 5 Pin | 6 Pin | 7 Pin | 8 Pin |
|--------|-------|-------|-------|-------|-------|-------|-------|
| A-code |       |       |       |       |       |       |       |
| B-code |       |       |       |       |       |       |       |
| D-code |       |       |       |       |       |       |       |

订货信息 / Order daec

| 芯数 / Number of cores | Coding | 料号 / Part number | Qty      | 芯数 / Number of cores | Coding | 料号 / Part number | Qty      |
|----------------------|--------|------------------|----------|----------------------|--------|------------------|----------|
| 02 Pin               | A-code | M12A02-03-116    | 1000 pcs | 02 Pin               | B-code | M12B02-03-116    | 1000 pcs |
| 03 Pin               | A-code | M12A03-03-116    | 1000 pcs | 03 Pin               | B-code | M12B03-03-116    | 1000 pcs |
| 04 Pin               | A-code | M12A04-03-116    | 1000 pcs | 04 Pin               | B-code | M12B04-03-116    | 1000 pcs |
| 05 Pin               | A-code | M12A05-03-116    | 1000 pcs | 05 Pin               | B-code | M12B05-03-116    | 1000 pcs |
| 06 Pin               | A-code | M12A06-03-116    | 1000 pcs | 02 Pin               | D-code | M12D02-03-116    | 1000 pcs |
| 07 Pin               | A-code | M12A07-03-116    | 1000 pcs | 03 Pin               | D-code | M12D03-03-116    | 1000 pcs |
| 08 Pin               | A-code | M12A08-03-116    | 1000 pcs | 04 Pin               | D-code | M12D04-03-116    | 1000 pcs |

技术参数 / Specifications

| 芯数 / Pin                      | 02 Pin                          | 03 Pin | 04 Pin | 05 Pin | 06 Pin | 07 Pin | 08 Pin |
|-------------------------------|---------------------------------|--------|--------|--------|--------|--------|--------|
| 额定电流 / Rated current          | 4 A                             | 4 A    | 4 A    | 4 A    | 2 A    | 2 A    | 2 A    |
| 额定电压 / Rated voltage          | 60 V                            | 60 V   | 60 V   | 60 V   | 30 V   | 30 V   | 30 V   |
| 标准 / Standard                 | IEC 61076-2-101                 |        |        |        |        |        |        |
| 接线方式 / Termination            | 焊线 / Solder                     |        |        |        |        |        |        |
| 锁紧方式 / Connect locking system | 螺纹锁紧 / Screw Lock               |        |        |        |        |        |        |
| 防护等级 / Degree of protection   | IP67 / IP68                     |        |        |        |        |        |        |
| 插拔次数 / Mechanical durability  | 500次                            |        |        |        |        |        |        |
| 工作温度 / Operation temperature  | -25 °C ~ +85 °C                 |        |        |        |        |        |        |
| 接触电阻 / Contact resistance     | ≤ 10mΩ                          |        |        |        |        |        |        |
| 绝缘电阻 / Insulation resistance  | ≥ 1000MΩ                        |        |        |        |        |        |        |
| 胶芯材料 / Housing material       | 尼龙PA66                          |        |        |        |        |        |        |
| 端子材料 / Pin material           | 黄铜镀金 / Brass With Gold Plated   |        |        |        |        |        |        |
| 螺丝材料 / Screw                  | 黄铜镀镍 / Brass With Nickel Plated |        |        |        |        |        |        |
| 壳体材料 / Outer shell material   | 黄铜镀镍 / Brass With Nickel Plated |        |        |        |        |        |        |
| 胶圈材料 / Gasket material        | 氟胶圈 / Fluorine Ring             |        |        |        |        |        |        |



## M12后锁面板式线端公头 焊线型M16/PG9 SW18T

产品图 / Product photo



尺寸图 / Dimension

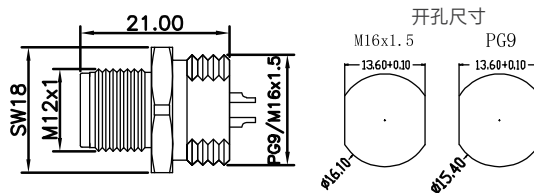

针位分布前视图 / Pin assignment front view

|        | 2 Pin | 3 Pin | 4 Pin | 5 Pin | 6 Pin | 7 Pin | 8 Pin |
|--------|-------|-------|-------|-------|-------|-------|-------|
| A-code |       |       |       |       |       |       |       |
| B-code |       |       |       |       |       |       |       |
| D-code |       |       |       |       |       |       |       |

订货信息 / Order daec

| 芯数 / Number of cores | Coding | 料号 / Part number      | Qty      | 芯数 / Number of cores | Coding | 料号 / Part number      | Qty      |
|----------------------|--------|-----------------------|----------|----------------------|--------|-----------------------|----------|
| 02 Pin               | A-code | M12A02-03-095-M16/PG9 | 1000 pcs | 02 Pin               | B-code | M12B02-03-095-M16/PG9 | 1000 pcs |
| 03 Pin               | A-code | M12A03-03-095-M16/PG9 | 1000 pcs | 03 Pin               | B-code | M12B03-03-095-M16/PG9 | 1000 pcs |
| 04 Pin               | A-code | M12A04-03-095-M16/PG9 | 1000 pcs | 04 Pin               | B-code | M12B04-03-095-M16/PG9 | 1000 pcs |
| 05 Pin               | A-code | M12A05-03-095-M16/PG9 | 1000 pcs | 05 Pin               | B-code | M12B05-03-095-M16/PG9 | 1000 pcs |
| 06 Pin               | A-code | M12A06-03-095-M16/PG9 | 1000 pcs | 02 Pin               | D-code | M12D02-03-095-M16/PG9 | 1000 pcs |
| 07 Pin               | A-code | M12A07-03-095-M16/PG9 | 1000 pcs | 03 Pin               | D-code | M12D03-03-095-M16/PG9 | 1000 pcs |
| 08 Pin               | A-code | M12A08-03-095-M16/PG9 | 1000 pcs | 04 Pin               | D-code | M12D04-03-095-M16/PG9 | 1000 pcs |

技术参数 / Specifications

| 芯数 / Pin                      | 02 Pin                          | 03 Pin | 04 Pin | 05 Pin | 06 Pin | 07 Pin | 08 Pin |
|-------------------------------|---------------------------------|--------|--------|--------|--------|--------|--------|
| 额定电流 / Rated current          | 4 A                             | 4 A    | 4 A    | 4 A    | 2 A    | 2 A    | 2 A    |
| 额定电压 / Rated voltage          | 60 V                            | 60 V   | 60 V   | 60 V   | 30 V   | 30 V   | 30 V   |
| 标准 / Standard                 | IEC 61076-2-101                 |        |        |        |        |        |        |
| 接线方式 / Termination            | 焊线 / Solder                     |        |        |        |        |        |        |
| 锁紧方式 / Connect locking system | 螺纹锁紧 / Screw Lock               |        |        |        |        |        |        |
| 防护等级 / Degree of protection   | IP67 / IP68                     |        |        |        |        |        |        |
| 插拔次数 / Mechanical durability  | 500次                            |        |        |        |        |        |        |
| 工作温度 / Operation temperature  | -25 °C ~ +85 °C                 |        |        |        |        |        |        |
| 接触电阻 / Contact resistance     | ≤ 10mΩ                          |        |        |        |        |        |        |
| 绝缘电阻 / Insulation resistance  | ≥ 1000MΩ                        |        |        |        |        |        |        |
| 胶芯材料 / Housing material       | 尼龙PA66                          |        |        |        |        |        |        |
| 端子材料 / Pin material           | 黄铜镀金 / Brass With Gold Plated   |        |        |        |        |        |        |
| 螺丝材料 / Screw                  | 黄铜镀镍 / Brass With Nickel Plated |        |        |        |        |        |        |
| 胶圈材料 / Gasket material        | 黄铜镀镍 / Brass With Nickel Plated |        |        |        |        |        |        |
| 胶圈材料 / Gasket material        | 氟胶圈 / Fluorine Ring             |        |        |        |        |        |        |

## M12后锁面板式线端母头 焊线型M16/PG9 SW17T

产品图 / Product photo



尺寸图 / Dimension

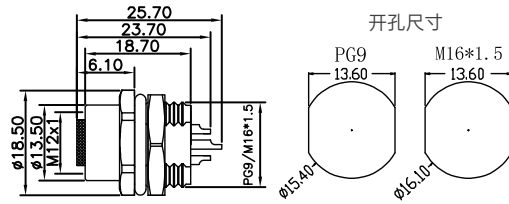

针位分布前视图 / Pin assignment front view

|        | 2 Pin | 3 Pin | 4 Pin | 5 Pin | 6 Pin | 7 Pin | 8 Pin |
|--------|-------|-------|-------|-------|-------|-------|-------|
| A-code |       |       |       |       |       |       |       |
| B-code |       |       |       |       |       |       |       |
| D-code |       |       |       |       |       |       |       |

订货信息 / Order daeo

| 芯数 / Number of cores | Coding | 料号 / Part number      | Qty      | 芯数 / Number of cores | Coding | 料号 / Part number      | Qty      |
|----------------------|--------|-----------------------|----------|----------------------|--------|-----------------------|----------|
| 02 Pin               | A-code | M12A02-04-098-M16/PG9 | 1000 pcs | 02 Pin               | B-code | M12B02-04-098-M16/PG9 | 1000 pcs |
| 03 Pin               | A-code | M12A03-04-098-M16/PG9 | 1000 pcs | 03 Pin               | B-code | M12B03-04-098-M16/PG9 | 1000 pcs |
| 04 Pin               | A-code | M12A04-04-098-M16/PG9 | 1000 pcs | 04 Pin               | B-code | M12B04-04-098-M16/PG9 | 1000 pcs |
| 05 Pin               | A-code | M12A05-04-098-M16/PG9 | 1000 pcs | 05 Pin               | B-code | M12B05-04-098-M16/PG9 | 1000 pcs |
| 06 Pin               | A-code | M12A06-04-098-M16/PG9 | 1000 pcs | 02 Pin               | D-code | M12D02-04-098-M16/PG9 | 1000 pcs |
| 07 Pin               | A-code | M12A07-04-098-M16/PG9 | 1000 pcs | 03 Pin               | D-code | M12D03-04-098-M16/PG9 | 1000 pcs |
| 08 Pin               | A-code | M12A08-04-098-M16/PG9 | 1000 pcs | 04 Pin               | D-code | M12D04-04-098-M16/PG9 | 1000 pcs |

技术参数 / Specifications

| 芯数 / Pin                      | 02 Pin                                 | 03 Pin | 04 Pin | 05 Pin | 06 Pin | 07 Pin | 08 Pin |
|-------------------------------|--|--------|--------|--------|--------|--------|--------|
| 额定电流 / Rated current          | 4 A                                    | 4 A    | 4 A    | 4 A    | 2 A    | 2 A    | 2 A    |
| 额定电压 / Rated voltage          | 60 V                                   | 60 V   | 60 V   | 60 V   | 30 V   | 30 V   | 30 V   |
| 标准 / Standard                 | IEC 61076-2-101                        |        |        |        |        |        |        |
| 接线方式 / Termination            | 焊线 / Solder                            |        |        |        |        |        |        |
| 锁紧方式 / Connect locking system | 螺纹锁紧 / Screw Lock                      |        |        |        |        |        |        |
| 防护等级 / Degree of protection   | IP67 / IP68                            |        |        |        |        |        |        |
| 插拔次数 / Mechanical durability  | 500次                                   |        |        |        |        |        |        |
| 工作温度 / Operation temperature  | -25 °C ~ +85 °C                        |        |        |        |        |        |        |
| 接触电阻 / Contact resistance     | ≤ 10mΩ                                 |        |        |        |        |        |        |
| 绝缘电阻 / Insulation resistance  | ≥ 1000MΩ                               |        |        |        |        |        |        |
| 胶芯材料 / Housing material       | 尼龙PA66                                 |        |        |        |        |        |        |
| 端子材料 / Pin material           | 黄铜镀金 / Brass With Gold Plated          |        |        |        |        |        |        |
| 螺丝材料 / Screw                  | 黄铜镀镍 / Brass With Nickel Plated        |        |        |        |        |        |        |
| 壳体材料 / Outer shell material   | 锌合金镀镍 / Zinc Alloys With Nickel Plated |        |        |        |        |        |        |
| 胶圈材料 / Gasket material        | 氟胶圈 / Fluorine Ring                    |        |        |        |        |        |        |

## M12后锁面板式8P线端母头 焊板型PG9 SW17T

产品图 / Product photo



尺寸图 / Dimension

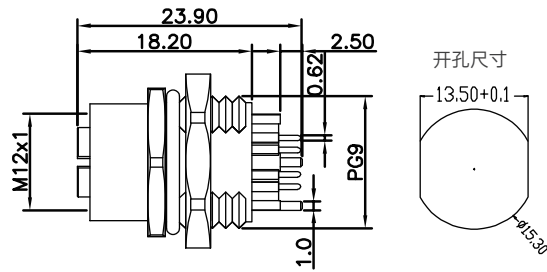

针位分布前视图 / Pin assignment front view



订货信息 / Order daea

| 芯数 / Number of cores | Coding | 料号 / Part number | Qty      |
|----------------------|--------|------------------|----------|
| 08 Pin               | X-code | M12X08-04-111    | 1000 pcs |

技术参数 / Specifications

| 芯数 / Pin                        | 08 Pin                                 |
|---------------------------------|--|
| 额定电流 / Rated current            | 0.5 A                                  |
| 额定电压 / Rated voltage            | 48 V                                   |
| 标准 / Standard                   | IEC 61076-2-101                        |
| 接线方式 / Termination              | 浸焊 / Dip-Solder                        |
| 锁紧方式 / Connect locking system   | 螺纹锁紧 / Screw Lock                      |
| 防护等级 / Degree of protection     | IP67 / IP68                            |
| 插拔次数 / Mechanical durability    | 500次                                   |
| 工作温度 / Operation temperature    | -25 °C ~ +85 °C                        |
| 接触电阻 / Contact resistance       | ≤ 10mΩ                                 |
| 绝缘电阻 / Insulation resistance    | > 1000MΩ                               |
| 胶芯材料 / Housing material         | 尼龙PA66                                 |
| 端子材料 / Pin material             | 黄铜镀金 / Brass With Gold Plated          |
| 螺丝材料 / Screw                    | 锌合金镀镍 / Zinc Alloys With Nickel Plated |
| 胶圈材料 / Gasket material          | 氟胶圈 / Fluorine Ring                    |
| 屏蔽罩材料 / Shielded shell material | 锌合金镀镍 / Zinc Alloys With Nickel Plated |

## M12成型式线端公头 焊线型屏蔽款+10.8L直纹螺丝

产品图 / Product photo



尺寸图 / Dimension

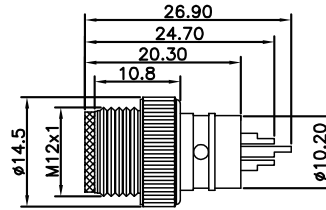

针位分布前视图 / Pin assignment front view

|        | 2 Pin | 3 Pin | 4 Pin | 5 Pin | 6 Pin | 7 Pin | 8 Pin |
|--------|-------|-------|-------|-------|-------|-------|-------|
| A-code |       |       |       |       |       |       |       |
| B-code |       |       |       |       |       |       |       |
| D-code |       |       |       |       |       |       |       |

订货信息 / Order daea

| 芯数 / Number of cores | Coding | 料号 / Part number | Qty      | 芯数 / Number of cores | Coding | 料号 / Part number | Qty      |
|----------------------|--------|------------------|----------|----------------------|--------|------------------|----------|
| 02 Pin               | A-code | M12A02-07-068    | 1000 pcs | 02 Pin               | B-code | M12B02-07-068    | 1000 pcs |
| 03 Pin               | A-code | M12A03-07-068    | 1000 pcs | 03 Pin               | B-code | M12B03-07-068    | 1000 pcs |
| 04 Pin               | A-code | M12A04-07-068    | 1000 pcs | 04 Pin               | B-code | M12B04-07-068    | 1000 pcs |
| 05 Pin               | A-code | M12A05-07-068    | 1000 pcs | 05 Pin               | B-code | M12B05-07-068    | 1000 pcs |
| 06 Pin               | A-code | M12A06-07-068    | 1000 pcs | 02 Pin               | D-code | M12D02-07-068    | 1000 pcs |
| 07 Pin               | A-code | M12A07-07-068    | 1000 pcs | 03 Pin               | D-code | M12D03-07-068    | 1000 pcs |
| 08 Pin               | A-code | M12A08-07-068    | 1000 pcs | 04 Pin               | D-code | M12D04-07-068    | 1000 pcs |

技术参数 / Specifications

| 芯数 / Pin   | 02 Pin                                    | 03 Pin | 04 Pin | 05 Pin | 06 Pin | 07 Pin | 08 Pin |
|--|---|--------|--------|--------|--------|--------|--------|
| 额定电流 / Rated current                                 | 4 A                                       | 4 A    | 4 A    | 4 A    | 2 A    | 2 A    | 2 A    |
| 额定电压 / Rated voltage                                 | 60 V                                      | 60 V   | 60 V   | 60 V   | 30 V   | 30 V   | 30 V   |
| 线规 (mm <sup>2</sup> ) / Wire gauge(mm <sup>2</sup> ) | 0.14mm <sup>2</sup> ~ 0.75mm <sup>2</sup> |        |        |        |        |        |        |
| 线号 (AWG) / Wire gauge(AWG)                           | 26AWG ~ 18AWG                             |        |        |        |        |        |        |
| 标准 / Standard  | IEC 61076-2-101                           |        |        |        |        |        |        |
| 接线方式 / Termination                                   | 焊线 / Solder                               |        |        |        |        |        |        |
| 锁紧方式 / Connect locking system                        | 螺纹锁紧 / Screw Lock                         |        |        |        |        |        |        |
| 防护等级 / Degree of protection                          | IP67 / IP68                               |        |        |        |        |        |        |
| 插拔次数 / Mechanical durability                         | 500次                                      |        |        |        |        |        |        |
| 工作温度 / Operation temperature                         | -25 °C ~ +85 °C                           |        |        |        |        |        |        |
| 接触电阻 / Contact resistance                            | ≤ 10mΩ                                    |        |        |        |        |        |        |
| 绝缘电阻 / Insulation resistance                         | ≥ 1000MΩ                                  |        |        |        |        |        |        |
| 胶芯材料 / Housing material                              | 尼龙PA66                                    |        |        |        |        |        |        |
| 端子材料 / Pin material                                  | 黄铜镀金 / Brass With Gold Plated             |        |        |        |        |        |        |
| 螺丝材料 / Screw   | 黄铜镀镍 / Brass With Nickel Plated           |        |        |        |        |        |        |
| 屏蔽管材料 / Spring                                       | 黄铜镀镍 / Brass With Nickel Plated           |        |        |        |        |        |        |

## M12成型式线端公头G款 焊线型+23L屏蔽管+防振动螺丝

产品图 / Product photo



尺寸图 / Dimension

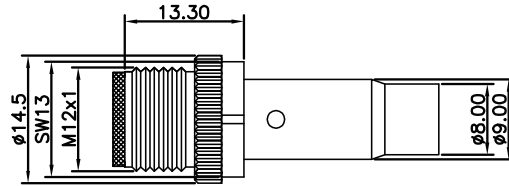

针位分布前视图 / Pin assignment front view

|        | 2 Pin | 3 Pin | 4 Pin | 5 Pin | 6 Pin | 7 Pin | 8 Pin |
|--------|-------|-------|-------|-------|-------|-------|-------|
| A-code |       |       |       |       |       |       |       |
| B-code |       |       |       |       |       |       |       |
| D-code |       |       |       |       |       |       |       |

订货信息 / Order daea

| 芯数 / Number of cores | Coding | 料号 / Part number | Qty      | 芯数 / Number of cores | Coding | 料号 / Part number | Qty      |
|----------------------|--------|------------------|----------|----------------------|--------|------------------|----------|
| 02 Pin               | A-code | M12A02-07-069    | 1000 pcs | 02 Pin               | B-code | M12B02-07-069    | 1000 pcs |
| 03 Pin               | A-code | M12A03-07-069    | 1000 pcs | 03 Pin               | B-code | M12B03-07-069    | 1000 pcs |
| 04 Pin               | A-code | M12A04-07-069    | 1000 pcs | 04 Pin               | B-code | M12B04-07-069    | 1000 pcs |
| 05 Pin               | A-code | M12A05-07-069    | 1000 pcs | 05 Pin               | B-code | M12B05-07-069    | 1000 pcs |
| 06 Pin               | A-code | M12A06-07-069    | 1000 pcs | 02 Pin               | D-code | M12D02-07-069    | 1000 pcs |
| 07 Pin               | A-code | M12A07-07-069    | 1000 pcs | 03 Pin               | D-code | M12D03-07-069    | 1000 pcs |
| 08 Pin               | A-code | M12A08-07-069    | 1000 pcs | 04 Pin               | D-code | M12D04-07-069    | 1000 pcs |

技术参数 / Specifications

| 芯数 / Pin   | 02 Pin                                    | 03 Pin | 04 Pin | 05 Pin | 06 Pin | 07 Pin | 08 Pin |
|--|---|--------|--------|--------|--------|--------|--------|
| 额定电流 / Rated current                                 | 4 A                                       | 4 A    | 4 A    | 4 A    | 2 A    | 2 A    | 2 A    |
| 额定电压 / Rated voltage                                 | 60 V                                      | 60 V   | 60 V   | 60 V   | 30 V   | 30 V   | 30 V   |
| 线规 (mm <sup>2</sup> ) / Wire gauge(mm <sup>2</sup> ) | 0.14mm <sup>2</sup> ~ 0.75mm <sup>2</sup> |        |        |        |        |        |        |
| 线号 (AWG) / Wire gauge(AWG)                           | 26AWG ~ 18AWG                             |        |        |        |        |        |        |
| 标准 / Standard  | IEC 61076-2-101                           |        |        |        |        |        |        |
| 接线方式 / Termination                                   | 焊线 / Solder                               |        |        |        |        |        |        |
| 锁紧方式 / Connect locking system                        | 螺纹锁紧 / Screw Lock                         |        |        |        |        |        |        |
| 防护等级 / Degree of protection                          | IP67 / IP68                               |        |        |        |        |        |        |
| 插拔次数 / Mechanical durability                         | 500次                                      |        |        |        |        |        |        |
| 工作温度 / Operation temperature                         | -25 °C ~ +85 °C                           |        |        |        |        |        |        |
| 接触电阻 / Contact resistance                            | ≤ 10mΩ                                    |        |        |        |        |        |        |
| 绝缘电阻 / Insulation resistance                         | ≥ 1000MΩ                                  |        |        |        |        |        |        |
| 胶芯材料 / Housing material                              | 尼龙PA66                                    |        |        |        |        |        |        |
| 端子材料 / Pin material                                  | 黄铜镀金 / Brass With Gold Plated             |        |        |        |        |        |        |
| 螺丝材料 / Screw   | 黄铜镀镍 / Brass With Nickel Plated           |        |        |        |        |        |        |
| 屏蔽管材料 / Spring                                       | 黄铜镀镍 / Brass With Nickel Plated           |        |        |        |        |        |        |

## M12成型式线端公头B款 焊线型+12L网纹POM螺丝

产品图 / Product photo



尺寸图 / Dimension

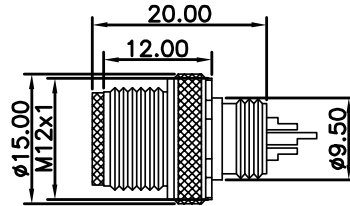

针位分布前视图 / Pin assignment front view

|        | 2 Pin | 3 Pin | 4 Pin | 5 Pin | 6 Pin | 7 Pin | 8 Pin |
|--------|-------|-------|-------|-------|-------|-------|-------|
| A-code |       |       |       |       |       |       |       |
| B-code |       |       |       |       |       |       |       |
| D-code |       |       |       |       |       |       |       |

订货信息 / Order daec

| 芯数 / Number of cores | Coding | 料号 / Part number | Qty      | 芯数 / Number of cores | Coding | 料号 / Part number | Qty      |
|----------------------|--------|------------------|----------|----------------------|--------|------------------|----------|
| 02 Pin               | A-code | M12A02-07-070    | 1000 pcs | 02 Pin               | B-code | M12B02-07-070    | 1000 pcs |
| 03 Pin               | A-code | M12A03-07-070    | 1000 pcs | 03 Pin               | B-code | M12B03-07-070    | 1000 pcs |
| 04 Pin               | A-code | M12A04-07-070    | 1000 pcs | 04 Pin               | B-code | M12B04-07-070    | 1000 pcs |
| 05 Pin               | A-code | M12A05-07-070    | 1000 pcs | 05 Pin               | B-code | M12B05-07-070    | 1000 pcs |
| 06 Pin               | A-code | M12A06-07-070    | 1000 pcs | 02 Pin               | D-code | M12D02-07-070    | 1000 pcs |
| 07 Pin               | A-code | M12A07-07-070    | 1000 pcs | 03 Pin               | D-code | M12D03-07-070    | 1000 pcs |
| 08 Pin               | A-code | M12A08-07-070    | 1000 pcs | 04 Pin               | D-code | M12D04-07-070    | 1000 pcs |

技术参数 / Specifications

| 芯数 / Pin   | 02 Pin                                    | 03 Pin | 04 Pin | 05 Pin | 06 Pin | 07 Pin | 08 Pin |
|--|---|--------|--------|--------|--------|--------|--------|
| 额定电流 / Rated current                                 | 4 A                                       | 4 A    | 4 A    | 4 A    | 2 A    | 2 A    | 2 A    |
| 额定电压 / Rated voltage                                 | 60 V                                      | 60 V   | 60 V   | 60 V   | 30 V   | 30 V   | 30 V   |
| 线规 (mm <sup>2</sup> ) / Wire gauge(mm <sup>2</sup> ) | 0.14mm <sup>2</sup> ~ 0.75mm <sup>2</sup> |        |        |        |        |        |        |
| 线号 (AWG) / Wire gauge(AWG)                           | 26AWG ~ 18AWG                             |        |        |        |        |        |        |
| 标准 / Standard  | IEC 61076-2-101                           |        |        |        |        |        |        |
| 接线方式 / Termination                                   | 焊线 / Solder                               |        |        |        |        |        |        |
| 锁紧方式 / Connect locking system                        | 螺纹锁紧 / Screw Lock                         |        |        |        |        |        |        |
| 防护等级 / Degree of protection                          | IP67 / IP68                               |        |        |        |        |        |        |
| 插拔次数 / Mechanical durability                         | 500次                                      |        |        |        |        |        |        |
| 工作温度 / Operation temperature                         | -25 °C ~ +85 °C                           |        |        |        |        |        |        |
| 接触电阻 / Contact resistance                            | ≤ 10mΩ                                    |        |        |        |        |        |        |
| 绝缘电阻 / Insulation resistance                         | ≥ 1000MΩ                                  |        |        |        |        |        |        |
| 胶芯材料 / Housing material                              | 尼龙PA66                                    |        |        |        |        |        |        |
| 端子材料 / Pin material                                  | 黄铜镀金 / Brass With Gold Plated             |        |        |        |        |        |        |
| 螺丝材料 / Screw   | 黄铜镀镍 / Brass With Nickel Plated           |        |        |        |        |        |        |

## M12成型式线端公头C款 焊线型+12L网纹POM螺丝

产品图 / Product photo



尺寸图 / Dimension

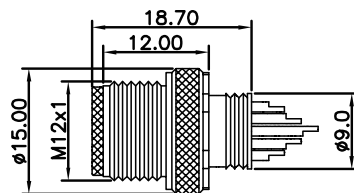

针位分布前视图 / Pin assignment front view

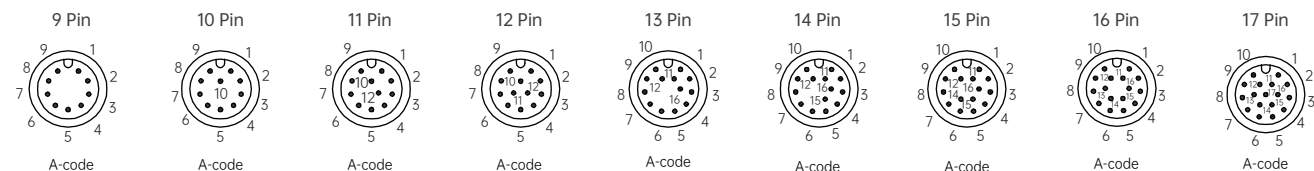

订货信息 / Order daec

| 芯数 / Number of cores | Coding | 料号 / Part number | Qty      |
|----------------------|--------|------------------|----------|
| 09 Pin               | A-code | M12A09-07-071    | 1000 pcs |
| 10 Pin               | A-code | M12A10-07-071    | 1000 pcs |
| 11 Pin               | A-code | M12A11-07-071    | 1000 pcs |
| 12 Pin               | A-code | M12A12-07-071    | 1000 pcs |
| 13 Pin               | A-code | M12A13-07-071    | 1000 pcs |
| 14 Pin               | A-code | M12A14-07-071    | 1000 pcs |
| 15 Pin               | A-code | M12A15-07-071    | 1000 pcs |
| 16 Pin               | A-code | M12A16-07-071    | 1000 pcs |
| 17 Pin               | A-code | M12A17-07-071    | 1000 pcs |

技术参数 / Specifications

| 芯数 / Pin   | 09 Pin                                    | 10 Pin | 11 Pin | 12 Pin | 13 Pin | 14 Pin | 15 Pin | 16 Pin | 17 Pin |
|--|---|--------|--------|--------|--------|--------|--------|--------|--------|
| 额定电流 / Rated current                                 | 1.5 A                                     |        |        |        |        |        |        |        |        |
| 额定电压 / Rated voltage                                 | 30 V                                      |        |        |        |        |        |        |        |        |
| 线规 (mm <sup>2</sup> ) / Wire gauge(mm <sup>2</sup> ) | 0.14mm <sup>2</sup> ~ 0.75mm <sup>2</sup> |        |        |        |        |        |        |        |        |
| 线号 (AWG) / Wire gauge(AWG)                           | 26AWG ~ 18AWG                             |        |        |        |        |        |        |        |        |
| 标准 / Standard  | IEC 61076-2-101                           |        |        |        |        |        |        |        |        |
| 接线方式 / Termination                                   | 焊线 / Solder                               |        |        |        |        |        |        |        |        |
| 锁紧方式 / Connect locking system                        | 螺纹锁紧 / Screw Lock                         |        |        |        |        |        |        |        |        |
| 防护等级 / Degree of protection                          | IP67 / IP68                               |        |        |        |        |        |        |        |        |
| 插拔次数 / Mechanical durability                         | 500次                                      |        |        |        |        |        |        |        |        |
| 工作温度 / Operation temperature                         | -25 °C ~ +85 °C                           |        |        |        |        |        |        |        |        |
| 接触电阻 / Contact resistance                            | ≤ 10mΩ                                    |        |        |        |        |        |        |        |        |
| 绝缘电阻 / Insulation resistance                         | ≥ 1000MΩ                                  |        |        |        |        |        |        |        |        |
| 胶芯材料 / Housing material                              | 尼龙PA66                                    |        |        |        |        |        |        |        |        |
| 端子材料 / Pin material                                  | 黄铜镀金 / Brass With Gold Plated             |        |        |        |        |        |        |        |        |
| 螺丝材料 / Screw   | POM                                       |        |        |        |        |        |        |        |        |

## M12成型式公头 焊线型 直纹螺丝

产品图 / Product photo



尺寸图 / Dimension

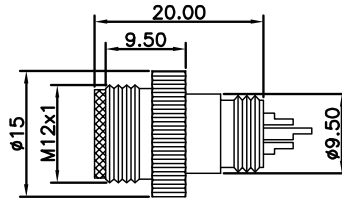

针位分布前视图 / Pin assignment front view

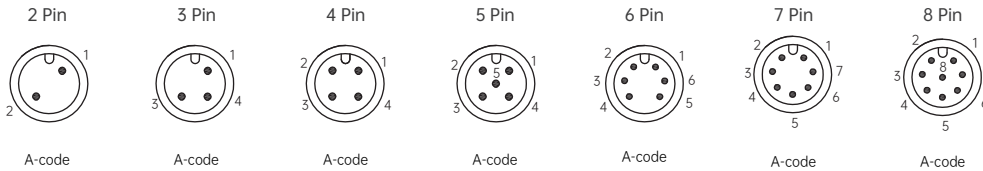

订货信息 / Order daea

| 芯数 / Number of cores | Coding | 料号 / Part number | Qty      |
|----------------------|--------|------------------|----------|
| 02 Pin               | A-code | M12A02-07-126    | 1000 pcs |
| 03 Pin               | A-code | M12A03-07-126    | 1000 pcs |
| 04 Pin               | A-code | M12A04-07-126    | 1000 pcs |
| 05 Pin               | A-code | M12A05-07-126    | 1000 pcs |
| 06 Pin               | A-code | M12A06-07-126    | 1000 pcs |
| 07 Pin               | A-code | M12A07-07-126    | 1000 pcs |
| 08 Pin               | A-code | M12A08-07-126    | 1000 pcs |

技术参数 / Specifications

| 芯数 / Pin   | 02 Pin                                    | 03 Pin | 04 Pin | 05 Pin | 06 Pin | 07 Pin | 08 Pin |
|--|---|--------|--------|--------|--------|--------|--------|
| 额定电流 / Rated current                                 | 4 A                                       | 4 A    | 4 A    | 4 A    | 2 A    | 2 A    | 2 A    |
| 额定电压 / Rated voltage                                 | 60 V                                      | 60 V   | 60 V   | 60 V   | 30 V   | 30 V   | 30 V   |
| 线规 (mm <sup>2</sup> ) / Wire gauge(mm <sup>2</sup> ) | 0.14mm <sup>2</sup> ~ 0.75mm <sup>2</sup> |        |        |        |        |        |        |
| 线号 (AWG) / Wire gauge(AWG)                           | 26AWG ~ 18AWG                             |        |        |        |        |        |        |
| 标准 / Standard  | IEC 61076-2-101                           |        |        |        |        |        |        |
| 接线方式 / Termination                                   | 焊线 / Solder                               |        |        |        |        |        |        |
| 锁紧方式 / Connect locking system                        | 螺纹锁紧 / Screw Lock                         |        |        |        |        |        |        |
| 防护等级 / Degree of protection                          | IP67 / IP68                               |        |        |        |        |        |        |
| 插拔次数 / Mechanical durability                         | 500次                                      |        |        |        |        |        |        |
| 工作温度 / Operation temperature                         | -25 °C ~ +85 °C                           |        |        |        |        |        |        |
| 接触电阻 / Contact resistance                            | ≤ 10mΩ                                    |        |        |        |        |        |        |
| 绝缘电阻 / Insulation resistance                         | ≥ 1000MΩ                                  |        |        |        |        |        |        |
| 胶芯材料 / Housing material                              | 尼龙PA66                                    |        |        |        |        |        |        |
| 端子材料 / Pin material                                  | 黄铜镀金 / Brass With Gold Plated             |        |        |        |        |        |        |
| 螺丝材料 / Screw   | 铝合金黑色/银色 / Al Alloy Black/Silver          |        |        |        |        |        |        |



## M12成型式线端公头G款 焊线式+13.3L防振动六角螺丝

产品图 / Product photo



尺寸图 / Dimension

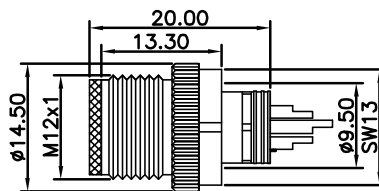

针位分布前视图 / Pin assignment front view

|        | 2 Pin | 3 Pin | 4 Pin | 5 Pin | 6 Pin | 7 Pin | 8 Pin |
|--------|-------|-------|-------|-------|-------|-------|-------|
| A-code |       |       |       |       |       |       |       |
| B-code |       |       |       |       |       |       |       |
| D-code |       |       |       |       |       |       |       |

订货信息 / Order daea

| 芯数 / Number of cores | Coding | 料号 / Part number | Qty      | 芯数 / Number of cores | Coding | 料号 / Part number | Qty      |
|----------------------|--------|------------------|----------|----------------------|--------|------------------|----------|
| 02 Pin               | A-code | M12A02-07-091    | 1000 pcs | 02 Pin               | B-code | M12B02-07-091    | 1000 pcs |
| 03 Pin               | A-code | M12A03-07-091    | 1000 pcs | 03 Pin               | B-code | M12B03-07-091    | 1000 pcs |
| 04 Pin               | A-code | M12A04-07-091    | 1000 pcs | 04 Pin               | B-code | M12B04-07-091    | 1000 pcs |
| 05 Pin               | A-code | M12A05-07-091    | 1000 pcs | 05 Pin               | B-code | M12B05-07-091    | 1000 pcs |
| 06 Pin               | A-code | M12A06-07-091    | 1000 pcs | 02 Pin               | D-code | M12D02-07-091    | 1000 pcs |
| 07 Pin               | A-code | M12A07-07-091    | 1000 pcs | 03 Pin               | D-code | M12D03-07-091    | 1000 pcs |
| 08 Pin               | A-code | M12A08-07-091    | 1000 pcs | 04 Pin               | D-code | M12D04-07-091    | 1000 pcs |

技术参数 / Specifications

| 芯数 / Pin   | 02 Pin                                    | 03 Pin | 04 Pin | 05 Pin | 06 Pin | 07 Pin | 08 Pin |
|--|---|--------|--------|--------|--------|--------|--------|
| 额定电流 / Rated current                                 | 4 A                                       | 4 A    | 4 A    | 4 A    | 2 A    | 2 A    | 2 A    |
| 额定电压 / Rated voltage                                 | 60 V                                      | 60 V   | 60 V   | 60 V   | 30 V   | 30 V   | 30 V   |
| 线规 (mm <sup>2</sup> ) / Wire gauge(mm <sup>2</sup> ) | 0.14mm <sup>2</sup> ~ 0.75mm <sup>2</sup> |        |        |        |        |        |        |
| 线号 (AWG) / Wire gauge(AWG)                           | 26AWG ~ 18AWG                             |        |        |        |        |        |        |
| 标准 / Standard  | IEC 61076-2-101                           |        |        |        |        |        |        |
| 接线方式 / Termination                                   | 焊线 / Solder                               |        |        |        |        |        |        |
| 锁紧方式 / Connect locking system                        | 螺纹锁紧 / Screw Lock                         |        |        |        |        |        |        |
| 防护等级 / Degree of protection                          | IP67 / IP68                               |        |        |        |        |        |        |
| 插拔次数 / Mechanical durability                         | 500次                                      |        |        |        |        |        |        |
| 工作温度 / Operation temperature                         | -25 °C ~ +85 °C                           |        |        |        |        |        |        |
| 接触电阻 / Contact resistance                            | ≤ 10mΩ                                    |        |        |        |        |        |        |
| 绝缘电阻 / Insulation resistance                         | ≥ 1000MΩ                                  |        |        |        |        |        |        |
| 胶芯材料 / Housing material                              | 尼龙PA66                                    |        |        |        |        |        |        |
| 端子材料 / Pin material                                  | 黄铜镀金 / Brass With Gold Plated             |        |        |        |        |        |        |
| 螺丝材料 / Screw   | 黄铜镀镍 / Brass With Nickel Plated           |        |        |        |        |        |        |

## M12成型式线端公头G款 焊线式+13.3L防振动六角螺丝

产品图 / Product photo



尺寸图 / Dimension

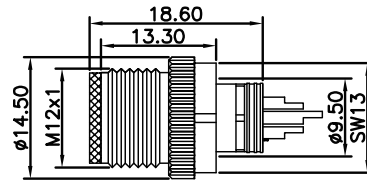

针位分布前视图 / Pin assignment front view

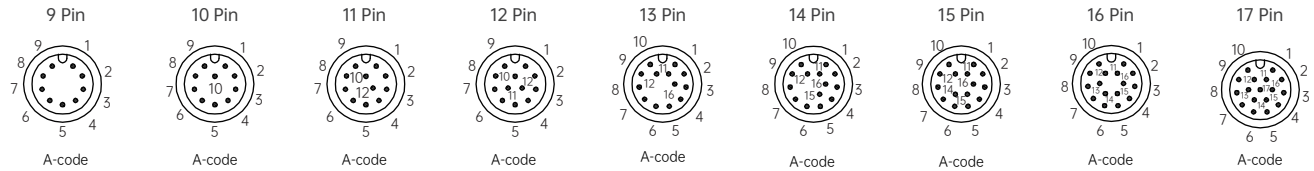

订货信息 / Order daec

| 芯数 / Number of cores | Coding | 料号 / Part number | Qty      |
|----------------------|--------|------------------|----------|
| 09 Pin               | A-code | M12A09-07-092    | 1000 pcs |
| 10 Pin               | A-code | M12A10-07-092    | 1000 pcs |
| 11 Pin               | A-code | M12A11-07-092    | 1000 pcs |
| 12 Pin               | A-code | M12A12-07-092    | 1000 pcs |
| 13 Pin               | A-code | M12A13-07-092    | 1000 pcs |
| 14 Pin               | A-code | M12A14-07-092    | 1000 pcs |
| 15 Pin               | A-code | M12A15-07-092    | 1000 pcs |
| 16 Pin               | A-code | M12A16-07-092    | 1000 pcs |
| 17 Pin               | A-code | M12A17-07-092    | 1000 pcs |

技术参数 / Specifications

| 芯数 / Pin   | 09 Pin                                    | 10 Pin | 11 Pin | 12 Pin | 13 Pin | 14 Pin | 15 Pin | 16 Pin | 17 Pin |
|--|---|--------|--------|--------|--------|--------|--------|--------|--------|
| 额定电流 / Rated current                                 | 1.5 A                                     |        |        |        |        |        |        |        |        |
| 额定电压 / Rated voltage                                 | 30 V                                      |        |        |        |        |        |        |        |        |
| 线规 (mm <sup>2</sup> ) / Wire gauge(mm <sup>2</sup> ) | 0.14mm <sup>2</sup> ~ 0.75mm <sup>2</sup> |        |        |        |        |        |        |        |        |
| 线号 (AWG) / Wire gauge(AWG)                           | 26AWG ~ 18AWG                             |        |        |        |        |        |        |        |        |
| 标准 / Standard  | IEC 61076-2-101                           |        |        |        |        |        |        |        |        |
| 接线方式 / Termination                                   | 焊线 / Solder                               |        |        |        |        |        |        |        |        |
| 锁紧方式 / Connect locking system                        | 螺纹锁紧 / Screw Lock                         |        |        |        |        |        |        |        |        |
| 防护等级 / Degree of protection                          | IP67 / IP68                               |        |        |        |        |        |        |        |        |
| 插拔次数 / Mechanical durability                         | 500次                                      |        |        |        |        |        |        |        |        |
| 工作温度 / Operation temperature                         | -25 °C ~ +85 °C                           |        |        |        |        |        |        |        |        |
| 接触电阻 / Contact resistance                            | ≤ 10mΩ                                    |        |        |        |        |        |        |        |        |
| 绝缘电阻 / Insulation resistance                         | ≥ 1000MΩ                                  |        |        |        |        |        |        |        |        |
| 胶芯材料 / Housing material                              | 尼龙PA66                                    |        |        |        |        |        |        |        |        |
| 端子材料 / Pin material                                  | 黄铜镀金 / Brass With Gold Plated             |        |        |        |        |        |        |        |        |
| 螺丝材料 / Screw   | 黄铜镀镍 / Brass With Nickel Plated           |        |        |        |        |        |        |        |        |

## M12成型式线端公头B款 焊线式+11.8L双网纹螺丝

产品图 / Product photo



尺寸图 / Dimension

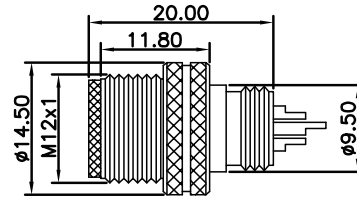

针位分布前视图 / Pin assignment front view

|        | 2 Pin | 3 Pin | 4 Pin | 5 Pin | 6 Pin | 7 Pin | 8 Pin |
|--------|-------|-------|-------|-------|-------|-------|-------|
| A-code |       |       |       |       |       |       |       |
| B-code |       |       |       |       |       |       |       |
| D-code |       |       |       |       |       |       |       |

订货信息 / Order daec

| 芯数 / Number of cores | Coding | 料号 / Part number | Qty      | 芯数 / Number of cores | Coding | 料号 / Part number | Qty      |
|----------------------|--------|------------------|----------|----------------------|--------|------------------|----------|
| 02 Pin               | A-code | M12A02-07-093    | 1000 pcs | 02 Pin               | B-code | M12B02-07-093    | 1000 pcs |
| 03 Pin               | A-code | M12A03-07-093    | 1000 pcs | 03 Pin               | B-code | M12B03-07-093    | 1000 pcs |
| 04 Pin               | A-code | M12A04-07-093    | 1000 pcs | 04 Pin               | B-code | M12B04-07-093    | 1000 pcs |
| 05 Pin               | A-code | M12A05-07-093    | 1000 pcs | 05 Pin               | B-code | M12B05-07-093    | 1000 pcs |
| 06 Pin               | A-code | M12A06-07-093    | 1000 pcs | 02 Pin               | D-code | M12D02-07-093    | 1000 pcs |
| 07 Pin               | A-code | M12A07-07-093    | 1000 pcs | 03 Pin               | D-code | M12D03-07-093    | 1000 pcs |
| 08 Pin               | A-code | M12A08-07-093    | 1000 pcs | 04 Pin               | D-code | M12D04-07-093    | 1000 pcs |

技术参数 / Specifications

| 芯数 / Pin   | 02 Pin                                    | 03 Pin | 04 Pin | 05 Pin | 06 Pin | 07 Pin | 08 Pin |
|--|---|--------|--------|--------|--------|--------|--------|
| 额定电流 / Rated current                                 | 4 A                                       | 4 A    | 4 A    | 4 A    | 2 A    | 2 A    | 2 A    |
| 额定电压 / Rated voltage                                 | 60 V                                      | 60 V   | 60 V   | 60 V   | 30 V   | 30 V   | 30 V   |
| 线规 (mm <sup>2</sup> ) / Wire gauge(mm <sup>2</sup> ) | 0.14mm <sup>2</sup> ~ 0.75mm <sup>2</sup> |        |        |        |        |        |        |
| 线号 (AWG) / Wire gauge(AWG)                           | 26AWG ~ 18AWG                             |        |        |        |        |        |        |
| 标准 / Standard  | IEC 61076-2-101                           |        |        |        |        |        |        |
| 接线方式 / Termination                                   | 焊线 / Solder                               |        |        |        |        |        |        |
| 锁紧方式 / Connect locking system                        | 螺纹锁紧 / Screw Lock                         |        |        |        |        |        |        |
| 防护等级 / Degree of protection                          | IP67 / IP68                               |        |        |        |        |        |        |
| 插拔次数 / Mechanical durability                         | 500次                                      |        |        |        |        |        |        |
| 工作温度 / Operation temperature                         | -25 °C ~ +85 °C                           |        |        |        |        |        |        |
| 接触电阻 / Contact resistance                            | ≤ 10mΩ                                    |        |        |        |        |        |        |
| 绝缘电阻 / Insulation resistance                         | ≥ 1000MΩ                                  |        |        |        |        |        |        |
| 胶芯材料 / Housing material                              | 尼龙PA66                                    |        |        |        |        |        |        |
| 端子材料 / Pin material                                  | 黄铜镀金 / Brass With Gold Plated             |        |        |        |        |        |        |
| 螺丝材料 / Screw   | 黄铜镀镍 / Brass With Nickel Plated           |        |        |        |        |        |        |

## M12成型式线端公头C款 焊线式+11.8L双网纹螺丝

产品图 / Product photo



尺寸图 / Dimension

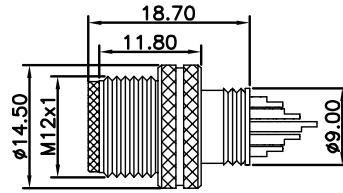

针位分布前视图 / Pin assignment front view

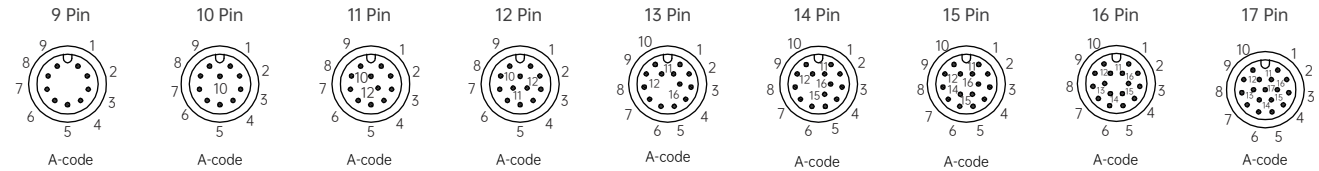

订货信息 / Order daec

| 芯数 / Number of cores | Coding | 料号 / Part number | Qty      |
|----------------------|--------|------------------|----------|
| 09 Pin               | A-code | M12A09-07-094    | 1000 pcs |
| 10 Pin               | A-code | M12A10-07-094    | 1000 pcs |
| 11 Pin               | A-code | M12A11-07-094    | 1000 pcs |
| 12 Pin               | A-code | M12A12-07-094    | 1000 pcs |
| 13 Pin               | A-code | M12A13-07-094    | 1000 pcs |
| 14 Pin               | A-code | M12A14-07-094    | 1000 pcs |
| 15 Pin               | A-code | M12A15-07-094    | 1000 pcs |
| 16 Pin               | A-code | M12A16-07-094    | 1000 pcs |
| 17 Pin               | A-code | M12A17-07-094    | 1000 pcs |

技术参数 / Specifications

| 芯数 / Pin   | 09 Pin                                    | 10 Pin | 11 Pin | 12 Pin | 13 Pin | 14 Pin | 15 Pin | 16 Pin | 17 Pin |
|--|---|--------|--------|--------|--------|--------|--------|--------|--------|
| 额定电流 / Rated current                                 | 1.5 A                                     |        |        |        |        |        |        |        |        |
| 额定电压 / Rated voltage                                 | 30 V                                      |        |        |        |        |        |        |        |        |
| 线规 (mm <sup>2</sup> ) / Wire gauge(mm <sup>2</sup> ) | 0.14mm <sup>2</sup> ~ 0.75mm <sup>2</sup> |        |        |        |        |        |        |        |        |
| 线号 (AWG) / Wire gauge(AWG)                           | 26AWG ~ 18AWG                             |        |        |        |        |        |        |        |        |
| 标准 / Standard  | IEC 61076-2-101                           |        |        |        |        |        |        |        |        |
| 接线方式 / Termination                                   | 焊线 / Solder                               |        |        |        |        |        |        |        |        |
| 锁紧方式 / Connect locking system                        | 螺纹锁紧 / Screw Lock                         |        |        |        |        |        |        |        |        |
| 防护等级 / Degree of protection                          | IP67 / IP68                               |        |        |        |        |        |        |        |        |
| 插拔次数 / Mechanical durability                         | 500次                                      |        |        |        |        |        |        |        |        |
| 工作温度 / Operation temperature                         | -25 °C ~ +85 °C                           |        |        |        |        |        |        |        |        |
| 接触电阻 / Contact resistance                            | ≤ 10mΩ                                    |        |        |        |        |        |        |        |        |
| 绝缘电阻 / Insulation resistance                         | ≥ 1000MΩ                                  |        |        |        |        |        |        |        |        |
| 胶芯材料 / Housing material                              | 尼龙PA66                                    |        |        |        |        |        |        |        |        |
| 端子材料 / Pin material                                  | 黄铜镀金 / Brass With Gold Plated             |        |        |        |        |        |        |        |        |
| 螺丝材料 / Screw   | 黄铜镀镍 / Brass With Nickel Plated           |        |        |        |        |        |        |        |        |

## M12成型式线端公头B款 焊线式+11L六角螺丝

产品图 / Product photo



尺寸图 / Dimension

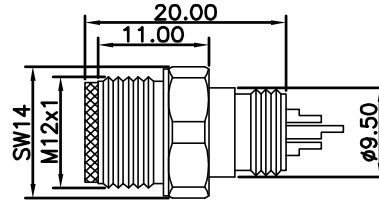

针位分布前视图 / Pin assignment front view

|        | 2 Pin | 3 Pin | 4 Pin | 5 Pin | 6 Pin | 7 Pin | 8 Pin |
|--------|-------|-------|-------|-------|-------|-------|-------|
| A-code |       |       |       |       |       |       |       |
| B-code |       |       |       |       |       |       |       |
| D-code |       |       |       |       |       |       |       |

订货信息 / Order daea

| 芯数 / Number of cores | Coding | 料号 / Part number | Qty      | 芯数 / Number of cores | Coding | 料号 / Part number | Qty      |
|----------------------|--------|------------------|----------|----------------------|--------|------------------|----------|
| 02 Pin               | A-code | M12A02-07-095    | 1000 pcs | 02 Pin               | B-code | M12B02-07-095    | 1000 pcs |
| 03 Pin               | A-code | M12A03-07-095    | 1000 pcs | 03 Pin               | B-code | M12B03-07-095    | 1000 pcs |
| 04 Pin               | A-code | M12A04-07-095    | 1000 pcs | 04 Pin               | B-code | M12B04-07-095    | 1000 pcs |
| 05 Pin               | A-code | M12A05-07-095    | 1000 pcs | 05 Pin               | B-code | M12B05-07-095    | 1000 pcs |
| 06 Pin               | A-code | M12A06-07-095    | 1000 pcs | 02 Pin               | D-code | M12D02-07-095    | 1000 pcs |
| 07 Pin               | A-code | M12A07-07-095    | 1000 pcs | 03 Pin               | D-code | M12D03-07-095    | 1000 pcs |
| 08 Pin               | A-code | M12A08-07-095    | 1000 pcs | 04 Pin               | D-code | M12D04-07-095    | 1000 pcs |

技术参数 / Specifications

| 芯数 / Pin   | 02 Pin                                    | 03 Pin | 04 Pin | 05 Pin | 06 Pin | 07 Pin | 08 Pin |
|--|---|--------|--------|--------|--------|--------|--------|
| 额定电流 / Rated current                                 | 4 A                                       | 4 A    | 4 A    | 4 A    | 2 A    | 2 A    | 2 A    |
| 额定电压 / Rated voltage                                 | 60 V                                      | 60 V   | 60 V   | 60 V   | 30 V   | 30 V   | 30 V   |
| 线规 (mm <sup>2</sup> ) / Wire gauge(mm <sup>2</sup> ) | 0.14mm <sup>2</sup> ~ 0.75mm <sup>2</sup> |        |        |        |        |        |        |
| 线号 (AWG) / Wire gauge(AWG)                           | 26AWG ~ 18AWG                             |        |        |        |        |        |        |
| 标准 / Standard  | IEC 61076-2-101                           |        |        |        |        |        |        |
| 接线方式 / Termination                                   | 焊线 / Solder                               |        |        |        |        |        |        |
| 锁紧方式 / Connect locking system                        | 螺纹锁紧 / Screw Lock                         |        |        |        |        |        |        |
| 防护等级 / Degree of protection                          | IP67 / IP68                               |        |        |        |        |        |        |
| 插拔次数 / Mechanical durability                         | 500次                                      |        |        |        |        |        |        |
| 工作温度 / Operation temperature                         | -25 °C ~ +85 °C                           |        |        |        |        |        |        |
| 接触电阻 / Contact resistance                            | ≤ 10mΩ                                    |        |        |        |        |        |        |
| 绝缘电阻 / Insulation resistance                         | ≥ 1000MΩ                                  |        |        |        |        |        |        |
| 胶芯材料 / Housing material                              | 尼龙PA66                                    |        |        |        |        |        |        |
| 端子材料 / Pin material                                  | 黄铜镀金 / Brass With Gold Plated             |        |        |        |        |        |        |
| 螺丝材料 / Screw   | 黄铜镀镍 / Brass With Nickel Plated           |        |        |        |        |        |        |

## M12成型式线端公头C款 焊线式+11L六角螺丝

产品图 / Product photo



尺寸图 / Dimension

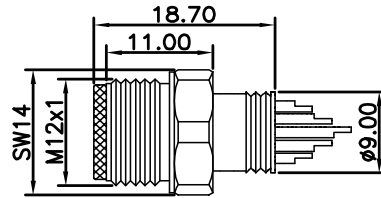

针位分布前视图 / Pin assignment front view

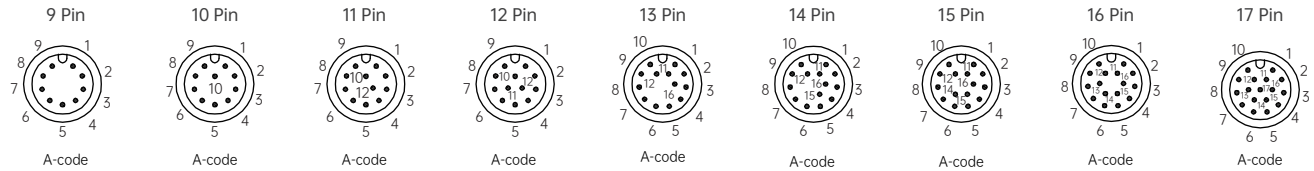

订货信息 / Order daec

| 芯数 / Number of cores | Coding | 料号 / Part number | Qty      |
|----------------------|--------|------------------|----------|
| 09 Pin               | A-code | M12A09-07-096    | 1000 pcs |
| 10 Pin               | A-code | M12A10-07-096    | 1000 pcs |
| 11 Pin               | A-code | M12A11-07-096    | 1000 pcs |
| 12 Pin               | A-code | M12A12-07-096    | 1000 pcs |
| 13 Pin               | A-code | M12A13-07-096    | 1000 pcs |
| 14 Pin               | A-code | M12A14-07-096    | 1000 pcs |
| 15 Pin               | A-code | M12A15-07-096    | 1000 pcs |
| 16 Pin               | A-code | M12A16-07-096    | 1000 pcs |
| 17 Pin               | A-code | M12A17-07-096    | 1000 pcs |

技术参数 / Specifications

| 芯数 / Pin   | 09 Pin                                    | 10 Pin | 11 Pin | 12 Pin | 13 Pin | 14 Pin | 15 Pin | 16 Pin | 17 Pin |
|--|---|--------|--------|--------|--------|--------|--------|--------|--------|
| 额定电流 / Rated current                                 | 1.5 A                                     |        |        |        |        |        |        |        |        |
| 额定电压 / Rated voltage                                 | 30 V                                      |        |        |        |        |        |        |        |        |
| 线规 (mm <sup>2</sup> ) / Wire gauge(mm <sup>2</sup> ) | 0.14mm <sup>2</sup> ~ 0.75mm <sup>2</sup> |        |        |        |        |        |        |        |        |
| 线号 (AWG) / Wire gauge(AWG)                           | 26AWG ~ 18AWG                             |        |        |        |        |        |        |        |        |
| 标准 / Standard  | IEC 61076-2-101                           |        |        |        |        |        |        |        |        |
| 接线方式 / Termination                                   | 焊线 / Solder                               |        |        |        |        |        |        |        |        |
| 锁紧方式 / Connect locking system                        | 螺纹锁紧 / Screw Lock                         |        |        |        |        |        |        |        |        |
| 防护等级 / Degree of protection                          | IP67 / IP68                               |        |        |        |        |        |        |        |        |
| 插拔次数 / Mechanical durability                         | 500次                                      |        |        |        |        |        |        |        |        |
| 工作温度 / Operation temperature                         | -25 °C ~ +85 °C                           |        |        |        |        |        |        |        |        |
| 接触电阻 / Contact resistance                            | ≤ 10mΩ                                    |        |        |        |        |        |        |        |        |
| 绝缘电阻 / Insulation resistance                         | ≥ 1000MΩ                                  |        |        |        |        |        |        |        |        |
| 胶芯材料 / Housing material                              | 尼龙PA66                                    |        |        |        |        |        |        |        |        |
| 端子材料 / Pin material                                  | 黄铜镀金 / Brass With Gold Plated             |        |        |        |        |        |        |        |        |
| 螺丝材料 / Screw   | 黄铜镀镍 / Brass With Nickel Plated           |        |        |        |        |        |        |        |        |

## M12成型式线端公头 焊线型屏蔽款+13L弹簧网纹螺丝

产品图 / Product photo



尺寸图 / Dimension

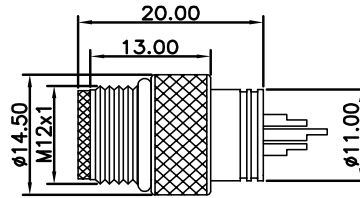

针位分布前视图 / Pin assignment front view

|        | 2 Pin | 3 Pin | 4 Pin | 5 Pin | 6 Pin | 7 Pin | 8 Pin |
|--------|-------|-------|-------|-------|-------|-------|-------|
| A-code |       |       |       |       |       |       |       |
| B-code |       |       |       |       |       |       |       |
| D-code |       |       |       |       |       |       |       |

订货信息 / Order daec

| 芯数 / Number of cores | Coding | 料号 / Part number | Qty      | 芯数 / Number of cores | Coding | 料号 / Part number | Qty      |
|----------------------|--------|------------------|----------|----------------------|--------|------------------|----------|
| 02 Pin               | A-code | M12A02-07-109    | 1000 pcs | 02 Pin               | B-code | M12B02-07-109    | 1000 pcs |
| 03 Pin               | A-code | M12A03-07-109    | 1000 pcs | 03 Pin               | B-code | M12B03-07-109    | 1000 pcs |
| 04 Pin               | A-code | M12A04-07-109    | 1000 pcs | 04 Pin               | B-code | M12B04-07-109    | 1000 pcs |
| 05 Pin               | A-code | M12A05-07-109    | 1000 pcs | 05 Pin               | B-code | M12B05-07-109    | 1000 pcs |
| 06 Pin               | A-code | M12A06-07-109    | 1000 pcs | 02 Pin               | D-code | M12D02-07-109    | 1000 pcs |
| 07 Pin               | A-code | M12A07-07-109    | 1000 pcs | 03 Pin               | D-code | M12D03-07-109    | 1000 pcs |
| 08 Pin               | A-code | M12A08-07-109    | 1000 pcs | 04 Pin               | D-code | M12D04-07-109    | 1000 pcs |

技术参数 / Specifications

| 芯数 / Pin   | 02 Pin                                    | 03 Pin | 04 Pin | 05 Pin | 06 Pin | 07 Pin | 08 Pin |
|--|---|--------|--------|--------|--------|--------|--------|
| 额定电流 / Rated current                                 | 4 A                                       | 4 A    | 4 A    | 4 A    | 2 A    | 2 A    | 2 A    |
| 额定电压 / Rated voltage                                 | 60 V                                      | 60 V   | 60 V   | 60 V   | 30 V   | 30 V   | 30 V   |
| 线规 (mm <sup>2</sup> ) / Wire gauge(mm <sup>2</sup> ) | 0.14mm <sup>2</sup> ~ 0.75mm <sup>2</sup> |        |        |        |        |        |        |
| 线号 (AWG) / Wire gauge(AWG)                           | 26AWG ~ 18AWG                             |        |        |        |        |        |        |
| 标准 / Standard  | IEC 61076-2-101                           |        |        |        |        |        |        |
| 接线方式 / Termination                                   | 焊线 / Solder                               |        |        |        |        |        |        |
| 锁紧方式 / Connect locking system                        | 螺纹锁紧 / Screw Lock                         |        |        |        |        |        |        |
| 防护等级 / Degree of protection                          | IP67 / IP68                               |        |        |        |        |        |        |
| 插拔次数 / Mechanical durability                         | 500次                                      |        |        |        |        |        |        |
| 工作温度 / Operation temperature                         | -25 °C ~ +85 °C                           |        |        |        |        |        |        |
| 接触电阻 / Contact resistance                            | ≤ 10mΩ                                    |        |        |        |        |        |        |
| 绝缘电阻 / Insulation resistance                         | ≥ 1000MΩ                                  |        |        |        |        |        |        |
| 胶芯材料 / Housing material                              | 尼龙PA66                                    |        |        |        |        |        |        |
| 端子材料 / Pin material                                  | 黄铜镀金 / Brass With Gold Plated             |        |        |        |        |        |        |
| 螺丝材料 / Screw   | 黄铜镀镍 / Brass With Nickel Plated           |        |        |        |        |        |        |
| 屏蔽罩材料 / Shielded shell material                      | 黄铜镀镍 / Brass With Nickel Plated           |        |        |        |        |        |        |
| 弹簧材料 / Spring material                               | 不锈钢 / Stainless Steel                     |        |        |        |        |        |        |
| 胶圈材料 / Gasket material                               | 氟胶圈 / Fluorine Ring                       |        |        |        |        |        |        |

## M12成型式线端公头 焊线型屏蔽款+10.8L直纹螺丝

产品图 / Product photo



尺寸图 / Dimension

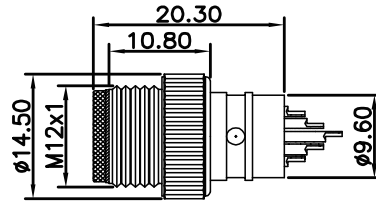

针位分布前视图 / Pin assignment front view

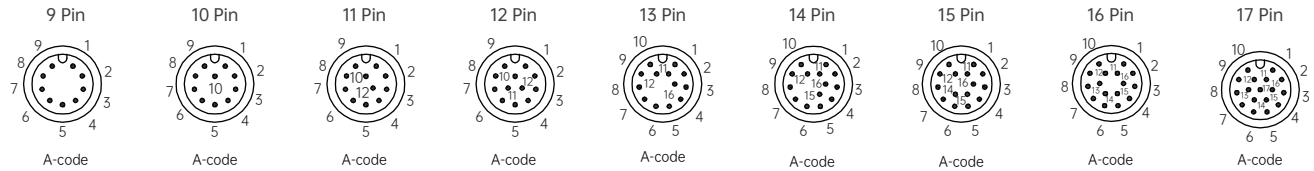

订货信息 / Order daec

| 芯数 / Number of cores | Coding | 料号 / Part number | Qty      |
|----------------------|--------|------------------|----------|
| 09 Pin               | A-code | M12A09-07-115    | 1000 pcs |
| 10 Pin               | A-code | M12A10-07-115    | 1000 pcs |
| 11 Pin               | A-code | M12A11-07-115    | 1000 pcs |
| 12 Pin               | A-code | M12A12-07-115    | 1000 pcs |
| 13 Pin               | A-code | M12A13-07-115    | 1000 pcs |
| 14 Pin               | A-code | M12A14-07-115    | 1000 pcs |
| 15 Pin               | A-code | M12A15-07-115    | 1000 pcs |
| 16 Pin               | A-code | M12A16-07-115    | 1000 pcs |
| 17 Pin               | A-code | M12A17-07-115    | 1000 pcs |

技术参数 / Specifications

| 芯数 / Pin   | 09 Pin                                    | 10 Pin | 11 Pin | 12 Pin | 13 Pin | 14 Pin | 15 Pin | 16 Pin | 17 Pin |
|--|---|--------|--------|--------|--------|--------|--------|--------|--------|
| 额定电流 / Rated current                                 | 1.5 A                                     |        |        |        |        |        |        |        |        |
| 额定电压 / Rated voltage                                 | 30 V                                      |        |        |        |        |        |        |        |        |
| 线规 (mm <sup>2</sup> ) / Wire gauge(mm <sup>2</sup> ) | 0.14mm <sup>2</sup> ~ 0.75mm <sup>2</sup> |        |        |        |        |        |        |        |        |
| 线号 (AWG) / Wire gauge(AWG)                           | 26AWG ~ 18AWG                             |        |        |        |        |        |        |        |        |
| 标准 / Standard  | IEC 61076-2-101                           |        |        |        |        |        |        |        |        |
| 接线方式 / Termination                                   | 焊线 / Solder                               |        |        |        |        |        |        |        |        |
| 锁紧方式 / Connect locking system                        | 螺纹锁紧 / Screw Lock                         |        |        |        |        |        |        |        |        |
| 防护等级 / Degree of protection                          | IP67 / IP68                               |        |        |        |        |        |        |        |        |
| 插拔次数 / Mechanical durability                         | 500次                                      |        |        |        |        |        |        |        |        |
| 工作温度 / Operation temperature                         | -25 °C ~ +85 °C                           |        |        |        |        |        |        |        |        |
| 接触电阻 / Contact resistance                            | ≤ 10mΩ                                    |        |        |        |        |        |        |        |        |
| 绝缘电阻 / Insulation resistance                         | ≥ 1000MΩ                                  |        |        |        |        |        |        |        |        |
| 胶芯材料 / Housing material                              | 尼龙PA66                                    |        |        |        |        |        |        |        |        |
| 端子材料 / Pin material                                  | 黄铜镀金 / Brass With Gold Plated             |        |        |        |        |        |        |        |        |
| 螺丝材料 / Screw   | 黄铜镀镍 / Brass With Nickel Plated           |        |        |        |        |        |        |        |        |
| 屏蔽罩材料 / Shielded shell material                      | 黄铜镀镍 / Brass With Nickel Plated           |        |        |        |        |        |        |        |        |



## M12成型式线端公头C款 焊线型+11.8L直纹螺丝

产品图 / Product photo



尺寸图 / Dimension

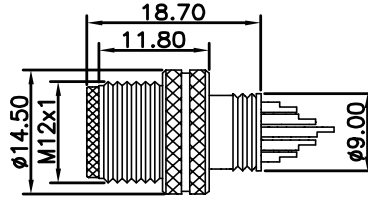

针位分布前视图 / Pin assignment front view

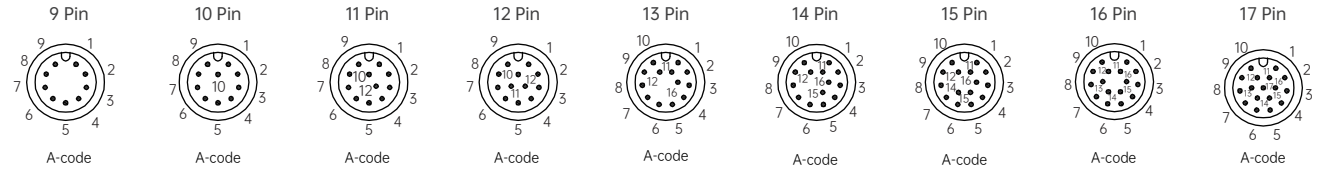

订货信息 / Order daea

| 芯数 / Number of cores | Coding | 料号 / Part number | Qty      |
|----------------------|--------|------------------|----------|
| 09 Pin               | A-code | M12A09-07-110    | 1000 pcs |
| 10 Pin               | A-code | M12A10-07-110    | 1000 pcs |
| 11 Pin               | A-code | M12A11-07-110    | 1000 pcs |
| 12 Pin               | A-code | M12A12-07-110    | 1000 pcs |
| 13 Pin               | A-code | M12A13-07-110    | 1000 pcs |
| 14 Pin               | A-code | M12A14-07-110    | 1000 pcs |
| 15 Pin               | A-code | M12A15-07-110    | 1000 pcs |
| 16 Pin               | A-code | M12A16-07-110    | 1000 pcs |
| 17 Pin               | A-code | M12A17-07-110    | 1000 pcs |

技术参数 / Specifications

| 芯数 / Pin   | 09 Pin                                    | 10 Pin | 11 Pin | 12 Pin | 13 Pin | 14 Pin | 15 Pin | 16 Pin | 17 Pin |
|--|---|--------|--------|--------|--------|--------|--------|--------|--------|
| 额定电流 / Rated current                                 | 1.5 A                                     |        |        |        |        |        |        |        |        |
| 额定电压 / Rated voltage                                 | 30 V                                      |        |        |        |        |        |        |        |        |
| 线规 (mm <sup>2</sup> ) / Wire gauge(mm <sup>2</sup> ) | 0.14mm <sup>2</sup> ~ 0.75mm <sup>2</sup> |        |        |        |        |        |        |        |        |
| 线号 (AWG) / Wire gauge(AWG)                           | 26AWG ~ 18AWG                             |        |        |        |        |        |        |        |        |
| 标准 / Standard  | IEC 61076-2-101                           |        |        |        |        |        |        |        |        |
| 接线方式 / Termination                                   | 焊线 / Solder                               |        |        |        |        |        |        |        |        |
| 锁紧方式 / Connect locking system                        | 螺纹锁紧 / Screw Lock                         |        |        |        |        |        |        |        |        |
| 防护等级 / Degree of protection                          | IP67 / IP68                               |        |        |        |        |        |        |        |        |
| 插拔次数 / Mechanical durability                         | 500次                                      |        |        |        |        |        |        |        |        |
| 工作温度 / Operation temperature                         | -25 °C ~ +85 °C                           |        |        |        |        |        |        |        |        |
| 接触电阻 / Contact resistance                            | ≤ 5mΩ                                     |        |        |        |        |        |        |        |        |
| 绝缘电阻 / Insulation resistance                         | ≥ 1000MΩ                                  |        |        |        |        |        |        |        |        |
| 胶芯材料 / Housing material                              | 尼龙PA66                                    |        |        |        |        |        |        |        |        |
| 端子材料 / Pin material                                  | 黄铜镀金 / Brass With Gold Plated             |        |        |        |        |        |        |        |        |
| 螺丝材料 / Screw   | 黄铜镀镍 / Brass With Nickel Plated           |        |        |        |        |        |        |        |        |

## M12成型式线端公头C款 焊线型+11.8L双网纹螺丝

产品图 / Product photo



尺寸图 / Dimension

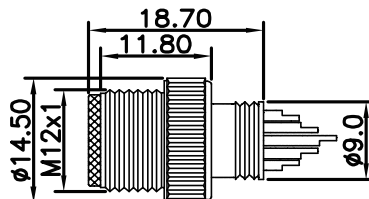

针位分布前视图 / Pin assignment front view

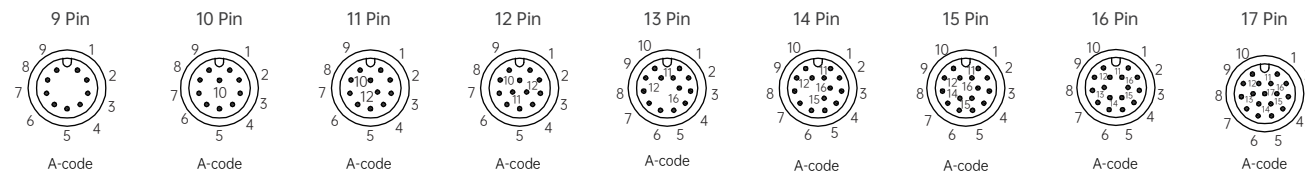

订货信息 / Order daec

| 芯数 / Number of cores | Coding | 料号 / Part number | Qty      |
|----------------------|--------|------------------|----------|
| 09 Pin               | A-code | M12A09-07-111    | 1000 pcs |
| 10 Pin               | A-code | M12A10-07-111    | 1000 pcs |
| 11 Pin               | A-code | M12A11-07-111    | 1000 pcs |
| 12 Pin               | A-code | M12A12-07-111    | 1000 pcs |
| 13 Pin               | A-code | M12A13-07-111    | 1000 pcs |
| 14 Pin               | A-code | M12A14-07-111    | 1000 pcs |
| 15 Pin               | A-code | M12A15-07-111    | 1000 pcs |
| 16 Pin               | A-code | M12A16-07-111    | 1000 pcs |
| 17 Pin               | A-code | M12A17-07-111    | 1000 pcs |

技术参数 / Specifications

| 芯数 / Pin   | 09 Pin                                    | 10 Pin | 11 Pin | 12 Pin | 13 Pin | 14 Pin | 15 Pin | 16 Pin | 17 Pin |
|--|---|--------|--------|--------|--------|--------|--------|--------|--------|
| 额定电流 / Rated current                                 | 1.5 A                                     |        |        |        |        |        |        |        |        |
| 额定电压 / Rated voltage                                 | 30 V                                      |        |        |        |        |        |        |        |        |
| 线规 (mm <sup>2</sup> ) / Wire gauge(mm <sup>2</sup> ) | 0.14mm <sup>2</sup> ~ 0.75mm <sup>2</sup> |        |        |        |        |        |        |        |        |
| 线号 (AWG) / Wire gauge(AWG)                           | 26AWG ~ 18AWG                             |        |        |        |        |        |        |        |        |
| 标准 / Standard  | IEC 61076-2-101                           |        |        |        |        |        |        |        |        |
| 接线方式 / Termination                                   | 焊线 / Solder                               |        |        |        |        |        |        |        |        |
| 锁紧方式 / Connect locking system                        | 螺纹锁紧 / Screw Lock                         |        |        |        |        |        |        |        |        |
| 防护等级 / Degree of protection                          | IP67 / IP68                               |        |        |        |        |        |        |        |        |
| 插拔次数 / Mechanical durability                         | 500次                                      |        |        |        |        |        |        |        |        |
| 工作温度 / Operation temperature                         | -25 °C ~ +85 °C                           |        |        |        |        |        |        |        |        |
| 接触电阻 / Contact resistance                            | ≤ 5mΩ                                     |        |        |        |        |        |        |        |        |
| 绝缘电阻 / Insulation resistance                         | ≥ 1000MΩ                                  |        |        |        |        |        |        |        |        |
| 胶芯材料 / Housing material                              | 尼龙PA66                                    |        |        |        |        |        |        |        |        |
| 端子材料 / Pin material                                  | 黄铜镀金 / Brass With Gold Plated             |        |        |        |        |        |        |        |        |
| 螺丝材料 / Screw   | 黄铜镀镍 / Brass With Nickel Plated           |        |        |        |        |        |        |        |        |

## M12成型式线端公头 L编码焊线型+11.8L双网纹螺丝

产品图 / Product photo



尺寸图 / Dimension

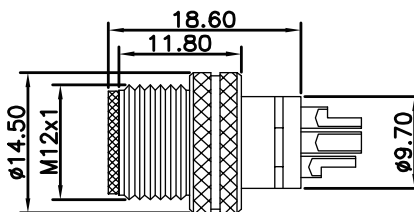

针位分布前视图 / Pin assignment front view

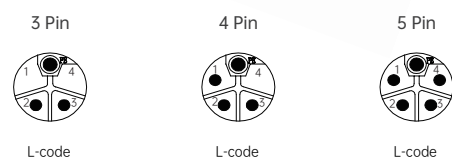

订货信息 / Order daec

| 芯数 / Number of cores | Coding | 料号 / Part number | Qty      |
|----------------------|--------|------------------|----------|
| 03 Pin               | L-code | M12L03-07-117    | 1000 pcs |
| 04 Pin               | L-code | M12L04-07-117    | 1000 pcs |
| 05 Pin               | L-code | M12L05-07-117    | 1000 pcs |

技术参数 / Specifications

| 芯数 / Pin   | 03 Pin | 04 Pin                                    | 05 Pin |
|--|--------|---|--------|
| 额定电流 / Rated current                                 |        | 16 A                                      |        |
| 额定电压 / Rated voltage                                 |        | 63 V                                      |        |
| 线规 (mm <sup>2</sup> ) / Wire gauge(mm <sup>2</sup> ) |        | 0.14mm <sup>2</sup> ~ 0.75mm <sup>2</sup> |        |
| 线号 (AWG) / Wire gauge(AWG)                           |        | 26AWG ~ 18AWG                             |        |
| 标准 / Standard  |        | IEC 61076-2-101                           |        |
| 接线方式 / Termination                                   |        | 焊线 / Solder                               |        |
| 锁紧方式 / Connect locking system                        |        | 螺纹锁紧 / Screw Lock                         |        |
| 防护等级 / Degree of protection                          |        | IP67 / IP68                               |        |
| 插拔次数 / Mechanical durability                         |        | 500次                                      |        |
| 工作温度 / Operation temperature                         |        | -25 °C ~ +85 °C                           |        |
| 接触电阻 / Contact resistance                            |        | ≤ 5mΩ                                     |        |
| 绝缘电阻 / Insulation resistance                         |        | ≥ 1000MΩ                                  |        |
| 胶芯材料 / Housing material                              |        | 尼龙PA66                                    |        |
| 端子材料 / Pin material                                  |        | 黄铜镀金 / Brass With Gold Plated             |        |
| 屏蔽管材料 / Spring                                       |        | 黄铜镀镍 / Brass With Nickel Plated           |        |

## M12成型式线端公头 T编码焊线型+11.8L网纹螺丝

产品图 / Product photo



尺寸图 / Dimension

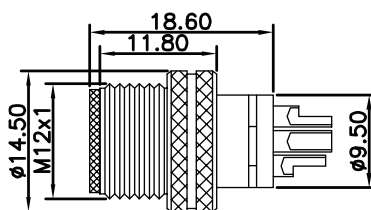

针位分布前视图 / Pin assignment front view

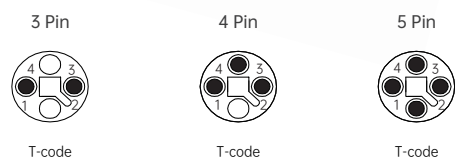

订货信息 / Order daec

| 芯数 / Number of cores | Coding | 料号 / Part number | Qty      |
|----------------------|--------|------------------|----------|
| 03 Pin               | T-code | M12T03-07-124    | 1000 pcs |
| 04 Pin               | T-code | M12T04-07-124    | 1000 pcs |
| 05 Pin               | T-code | M12T05-07-124    | 1000 pcs |

技术参数 / Specifications

| 芯数 / Pin   | 03 Pin | 04 Pin                                    | 05 Pin |
|--|--------|---|--------|
| 额定电流 / Rated current                                 |        | 12 A                                      |        |
| 额定电压 / Rated voltage                                 |        | 50V/63 V                                  |        |
| 线规 (mm <sup>2</sup> ) / Wire gauge(mm <sup>2</sup> ) |        | 0.14mm <sup>2</sup> ~ 0.75mm <sup>2</sup> |        |
| 线号 (AWG) / Wire gauge(AWG)                           |        | 26AWG ~ 18AWG                             |        |
| 标准 / Standard  |        | IEC 61076-2-101                           |        |
| 接线方式 / Termination                                   |        | 焊线 / Solder                               |        |
| 锁紧方式 / Connect locking system                        |        | 螺纹锁紧 / Screw Lock                         |        |
| 防护等级 / Degree of protection                          |        | IP67 / IP68                               |        |
| 插拔次数 / Mechanical durability                         |        | 500次                                      |        |
| 工作温度 / Operation temperature                         |        | -25 °C ~ +85 °C                           |        |
| 接触电阻 / Contact resistance                            |        | ≤ 5mΩ                                     |        |
| 绝缘电阻 / Insulation resistance                         |        | ≥ 1000MΩ                                  |        |
| 胶芯材料 / Housing material                              |        | 尼龙PA66                                    |        |
| 端子材料 / Pin material                                  |        | 黄铜镀金 / Brass With Gold Plated             |        |
| 螺丝材料 / Screw   |        | 黄铜镀镍 / Brass With Nickel Plated           |        |

## M12成型式线端公头S编码 焊线型+11.8L双网纹螺丝

产品图 / Product photo



尺寸图 / Dimension

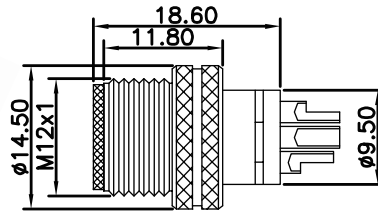

针位分布前视图 / Pin assignment front view

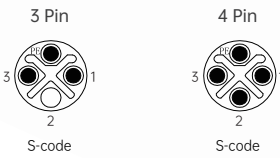

订货信息 / Order daea

| 芯数 / Number of cores | Coding | 料号 / Part number | Qty      |
|----------------------|--------|------------------|----------|
| 03 Pin               | S-code | M12S03-07-121    | 1000 pcs |
| 04 Pin               | S-code | M12S04-07-121    | 1000 pcs |

技术参数 / Specifications

| 芯数 / Pin   | 03 Pin                                    | 04 Pin |
|--|---|--------|
| 额定电流 / Rated current                                 | 12 A                                      |        |
| 额定电压 / Rated voltage                                 | 630 V                                     |        |
| 线规 (mm <sup>2</sup> ) / Wire gauge(mm <sup>2</sup> ) | 0.14mm <sup>2</sup> ~ 0.75mm <sup>2</sup> |        |
| 线号 (AWG) / Wire gauge(AWG)                           | 26AWG ~ 18AWG                             |        |
| 标准 / Standard  | IEC 61076-2-101                           |        |
| 接线方式 / Termination                                   | 焊线 / Solder                               |        |
| 锁紧方式 / Connect locking system                        | 螺纹锁紧 / Screw Lock                         |        |
| 防护等级 / Degree of protection                          | IP67 / IP68                               |        |
| 插拔次数 / Mechanical durability                         | 500次                                      |        |
| 工作温度 / Operation temperature                         | -25 °C ~ +85 °C                           |        |
| 接触电阻 / Contact resistance                            | ≤ 5mΩ                                     |        |
| 绝缘电阻 / Insulation resistance                         | ≥ 1000MΩ                                  |        |
| 胶芯材料 / Housing material                              | 尼龙PA66                                    |        |
| 端子材料 / Pin material                                  | 黄铜镀金 / Brass With Gold Plated             |        |
| 螺丝材料 / Screw   | 黄铜镀镍 / Brass With Nickel Plated           |        |

## M12成型式8P线端公头X编码 焊线型装配式三件套

产品图 / Product photo



尺寸图 / Dimension

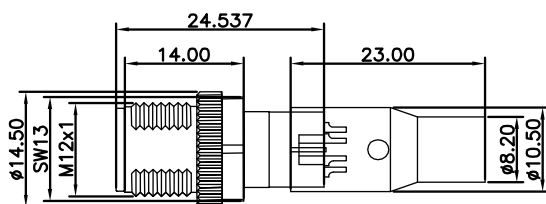

针位分布前视图 / Pin assignment front view



订货信息 / Order daec

| 芯数 / Number of cores | Coding | 料号 / Part number | Qty      |
|----------------------|--------|------------------|----------|
| 08 Pin               | X-code | M12X08-01-026    | 1000 pcs |

技术参数 / Specifications

| 芯数 / Pin   | 08 Pin                                 |
|--|--|
| 额定电流 / Rated current                                 | 0.5 A                                  |
| 额定电压 / Rated voltage                                 | 48 V                                   |
| 线规 (mm <sup>2</sup> ) / Wire gauge(mm <sup>2</sup> ) | 0.14mm <sup>2</sup>                    |
| 线号 (AWG) / Wire gauge(AWG)                           | 26AWG                                  |
| 标准 / Standard  | IEC 61076-2-101                        |
| 接线方式 / Termination                                   | 焊线 / Solder                            |
| 锁紧方式 / Connect locking system                        | 螺纹锁紧 / Screw Lock                      |
| 防护等级 / Degree of protection                          | IP67 / IP68                            |
| 插拔次数 / Mechanical durability                         | 500次                                   |
| 工作温度 / Operation temperature                         | -25 °C ~ +85 °C                        |
| 接触电阻 / Contact resistance                            | ≤ 5mΩ                                  |
| 绝缘电阻 / Insulation resistance                         | ≥ 1000MΩ                               |
| 胶芯材料 / Housing material                              | 尼龙PA66                                 |
| 端子材料 / Pin material                                  | 黄铜镀金 / Brass With Gold Plated          |
| 螺丝材料 / Screw   | 锌合金镀镍 / Zinc Alloys With Nickel Plated |
| 胶圈材料 / Gasket material                               | 氟胶圈 / Fluorine Ring                    |
| 屏蔽罩材料 / Shielded shell material                      | 锌合金镀镍 / Zinc Alloys With Nickel Plated |

## M12成型式8P线端公头X编码 焊线型装配式+锁牙屏蔽管

产品图 / Product photo



尺寸图 / Dimension

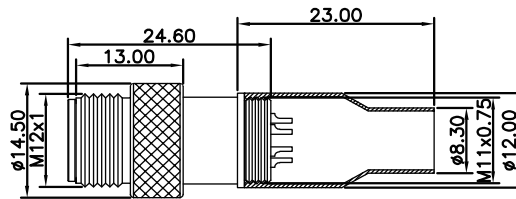

针位分布前视图 / Pin assignment front view



订货信息 / Order daea

| 芯数 / Number of cores | Coding | 料号 / Part number | Qty      |
|----------------------|--------|------------------|----------|
| 08 Pin               | X-code | M12X08-01-027    | 1000 pcs |

技术参数 / Specifications

| 芯数 / Pin   | 08 Pin                                 |
|--|--|
| 额定电流 / Rated current                                 | 0.5 A                                  |
| 额定电压 / Rated voltage                                 | 48 V                                   |
| 线规 (mm <sup>2</sup> ) / Wire gauge(mm <sup>2</sup> ) | 0.14mm <sup>2</sup>                    |
| 线号 (AWG) / Wire gauge(AWG)                           | 26AWG                                  |
| 标准 / Standard  | IEC 61076-2-101                        |
| 接线方式 / Termination                                   | 焊线 / Solder                            |
| 锁紧方式 / Connect locking system                        | 螺纹锁紧 / Screw Lock                      |
| 防护等级 / Degree of protection                          | IP67 / IP68                            |
| 插拔次数 / Mechanical durability                         | 500次                                   |
| 工作温度 / Operation temperature                         | -25 °C ~ +85 °C                        |
| 接触电阻 / Contact resistance                            | ≤ 5mΩ                                  |
| 绝缘电阻 / Insulation resistance                         | ≥ 1000MΩ                               |
| 胶芯材料 / Housing material                              | 尼龙PA66                                 |
| 端子材料 / Pin material                                  | 黄铜镀金 / Brass With Gold Plated          |
| 螺丝材料 / Screw   | 锌合金镀镍 / Zinc Alloys With Nickel Plated |
| 胶圈材料 / Gasket material                               | 氟胶圈 / Fluorine Ring                    |
| 屏蔽罩材料 / Shielded shell material                      | 锌合金镀镍 / Zinc Alloys With Nickel Plated |

## M12成型式线端母头 焊线型屏蔽款+10L直纹螺母

产品图 / Product photo



尺寸图 / Dimension

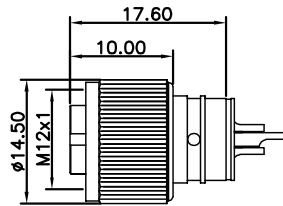

针位分布前视图 / Pin assignment front view

|        | 2 Pin | 3 Pin | 4 Pin | 5 Pin | 6 Pin | 7 Pin | 8 Pin |
|--------|-------|-------|-------|-------|-------|-------|-------|
| A-code |       |       |       |       |       |       |       |
| B-code |       |       |       |       |       |       |       |
| D-code |       |       |       |       |       |       |       |

订货信息 / Order daea

| 芯数 / Number of cores | Coding | 料号 / Part number | Qty      | 芯数 / Number of cores | Coding | 料号 / Part number | Qty      |
|----------------------|--------|------------------|----------|----------------------|--------|------------------|----------|
| 02 Pin               | A-code | M12A02-08-067    | 1000 pcs | 02 Pin               | B-code | M12B02-08-067    | 1000 pcs |
| 03 Pin               | A-code | M12A03-08-067    | 1000 pcs | 03 Pin               | B-code | M12B03-08-067    | 1000 pcs |
| 04 Pin               | A-code | M12A04-08-067    | 1000 pcs | 04 Pin               | B-code | M12B04-08-067    | 1000 pcs |
| 05 Pin               | A-code | M12A05-08-067    | 1000 pcs | 05 Pin               | B-code | M12B05-08-067    | 1000 pcs |
| 06 Pin               | A-code | M12A06-08-067    | 1000 pcs | 02 Pin               | D-code | M12D02-08-067    | 1000 pcs |
| 07 Pin               | A-code | M12A07-08-067    | 1000 pcs | 03 Pin               | D-code | M12D03-08-067    | 1000 pcs |
| 08 Pin               | A-code | M12A08-08-067    | 1000 pcs | 04 Pin               | D-code | M12D04-08-067    | 1000 pcs |

技术参数 / Specifications

| 芯数 / Pin   | 02 Pin                                    | 03 Pin | 04 Pin | 05 Pin | 06 Pin | 07 Pin | 08 Pin |
|--|---|--------|--------|--------|--------|--------|--------|
| 额定电流 / Rated current                                 | 4 A                                       | 4 A    | 4 A    | 4 A    | 2 A    | 2 A    | 2 A    |
| 额定电压 / Rated voltage                                 | 60 V                                      | 60 V   | 60 V   | 60 V   | 30 V   | 30 V   | 30 V   |
| 线规 (mm <sup>2</sup> ) / Wire gauge(mm <sup>2</sup> ) | 0.14mm <sup>2</sup> ~ 0.75mm <sup>2</sup> |        |        |        |        |        |        |
| 线号 (AWG) / Wire gauge(AWG)                           | 26AWG ~ 18AWG                             |        |        |        |        |        |        |
| 标准 / Standard  | IEC 61076-2-101                           |        |        |        |        |        |        |
| 接线方式 / Termination                                   | 焊线 / Solder                               |        |        |        |        |        |        |
| 锁紧方式 / Connect locking system                        | 螺纹锁紧 / Screw Lock                         |        |        |        |        |        |        |
| 防护等级 / Degree of protection                          | IP67 / IP68                               |        |        |        |        |        |        |
| 插拔次数 / Mechanical durability                         | 500次                                      |        |        |        |        |        |        |
| 工作温度 / Operation temperature                         | -25 °C ~ +85 °C                           |        |        |        |        |        |        |
| 接触电阻 / Contact resistance                            | ≤ 10mΩ                                    |        |        |        |        |        |        |
| 绝缘电阻 / Insulation resistance                         | ≥ 1000MΩ                                  |        |        |        |        |        |        |
| 胶芯材料 / Housing material                              | 尼龙PA66                                    |        |        |        |        |        |        |
| 端子材料 / Pin material                                  | 黄铜镀金 / Brass With Gold Plated             |        |        |        |        |        |        |
| 螺丝材料 / Screw   | 黄铜镀镍 / Brass With Nickel Plated           |        |        |        |        |        |        |
| 屏蔽管材料 / Spring                                       | 黄铜镀镍 / Brass With Nickel Plated           |        |        |        |        |        |        |
| 胶圈材料 / Gasket material                               | 氟胶圈 / Fluorine Ring                       |        |        |        |        |        |        |



## M12成型式线端母头D款 焊线型+18L屏蔽管+防振动螺母

产品图 / Product photo



尺寸图 / Dimension

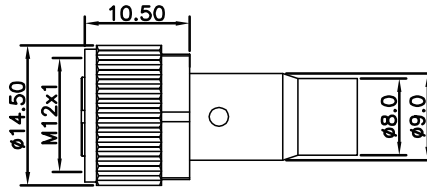

针位分布前视图 / Pin assignment front view

|        | 2 Pin | 3 Pin | 4 Pin | 5 Pin | 6 Pin | 7 Pin | 8 Pin |
|--------|-------|-------|-------|-------|-------|-------|-------|
| A-code |       |       |       |       |       |       |       |
| B-code |       |       |       |       |       |       |       |
| D-code |       |       |       |       |       |       |       |

订货信息 / Order daec

| 芯数 / Number of cores | Coding | 料号 / Part number | Qty      | 芯数 / Number of cores | Coding | 料号 / Part number | Qty      |
|----------------------|--------|------------------|----------|----------------------|--------|------------------|----------|
| 02 Pin               | A-code | M12A02-08-068    | 1000 pcs | 02 Pin               | B-code | M12B02-08-068    | 1000 pcs |
| 03 Pin               | A-code | M12A03-08-068    | 1000 pcs | 03 Pin               | B-code | M12B03-08-068    | 1000 pcs |
| 04 Pin               | A-code | M12A04-08-068    | 1000 pcs | 04 Pin               | B-code | M12B04-08-068    | 1000 pcs |
| 05 Pin               | A-code | M12A05-08-068    | 1000 pcs | 05 Pin               | B-code | M12B05-08-068    | 1000 pcs |
| 06 Pin               | A-code | M12A06-08-068    | 1000 pcs | 02 Pin               | D-code | M12D02-08-068    | 1000 pcs |
| 07 Pin               | A-code | M12A07-08-068    | 1000 pcs | 03 Pin               | D-code | M12D03-08-068    | 1000 pcs |
| 08 Pin               | A-code | M12A08-08-068    | 1000 pcs | 04 Pin               | D-code | M12D04-08-068    | 1000 pcs |

技术参数 / Specifications

| 芯数 / Pin   | 02 Pin                                    | 03 Pin | 04 Pin | 05 Pin | 06 Pin | 07 Pin | 08 Pin |
|--|---|--------|--------|--------|--------|--------|--------|
| 额定电流 / Rated current                                 | 4 A                                       | 4 A    | 4 A    | 4 A    | 2 A    | 2 A    | 2 A    |
| 额定电压 / Rated voltage                                 | 60 V                                      | 60 V   | 60 V   | 60 V   | 30 V   | 30 V   | 30 V   |
| 线规 (mm <sup>2</sup> ) / Wire gauge(mm <sup>2</sup> ) | 0.14mm <sup>2</sup> ~ 0.75mm <sup>2</sup> |        |        |        |        |        |        |
| 线号 (AWG) / Wire gauge(AWG)                           | 26AWG ~ 18AWG                             |        |        |        |        |        |        |
| 标准 / Standard  | IEC 61076-2-101                           |        |        |        |        |        |        |
| 接线方式 / Termination                                   | 焊线 / Solder                               |        |        |        |        |        |        |
| 锁紧方式 / Connect locking system                        | 螺纹锁紧 / Screw Lock                         |        |        |        |        |        |        |
| 防护等级 / Degree of protection                          | IP67 / IP68                               |        |        |        |        |        |        |
| 插拔次数 / Mechanical durability                         | 500次                                      |        |        |        |        |        |        |
| 工作温度 / Operation temperature                         | -25 °C ~ +85 °C                           |        |        |        |        |        |        |
| 接触电阻 / Contact resistance                            | ≤ 10mΩ                                    |        |        |        |        |        |        |
| 绝缘电阻 / Insulation resistance                         | ≥ 1000MΩ                                  |        |        |        |        |        |        |
| 胶芯材料 / Housing material                              | 尼龙PA66                                    |        |        |        |        |        |        |
| 端子材料 / Pin material                                  | 黄铜镀金 / Brass With Gold Plated             |        |        |        |        |        |        |
| 螺丝材料 / Screw   | 黄铜镀镍 / Brass With Nickel Plated           |        |        |        |        |        |        |
| 屏蔽管材料 / Spring                                       | 黄铜镀镍 / Brass With Nickel Plated           |        |        |        |        |        |        |
| 胶圈材料 / Gasket material                               | 氟胶圈 / Fluorine Ring                       |        |        |        |        |        |        |

## M12成型式线端母头C款 焊线型+10.5L网纹POM螺母

产品图 / Product photo



尺寸图 / Dimension

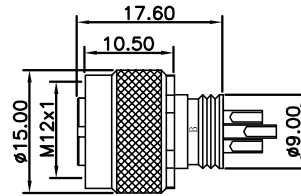

针位分布前视图 / Pin assignment front view

|        | 2 Pin | 3 Pin | 4 Pin | 5 Pin | 6 Pin | 7 Pin | 8 Pin |
|--------|-------|-------|-------|-------|-------|-------|-------|
| A-code |       |       |       |       |       |       |       |
| B-code |       |       |       |       |       |       |       |
| D-code |       |       |       |       |       |       |       |

订货信息 / Order daea

| 芯数 / Number of cores | Coding | 料号 / Part number | Qty      | 芯数 / Number of cores | Coding | 料号 / Part number | Qty      |
|----------------------|--------|------------------|----------|----------------------|--------|------------------|----------|
| 02 Pin               | A-code | M12A02-08-069    | 1000 pcs | 02 Pin               | B-code | M12B02-08-069    | 1000 pcs |
| 03 Pin               | A-code | M12A03-08-069    | 1000 pcs | 03 Pin               | B-code | M12B03-08-069    | 1000 pcs |
| 04 Pin               | A-code | M12A04-08-069    | 1000 pcs | 04 Pin               | B-code | M12B04-08-069    | 1000 pcs |
| 05 Pin               | A-code | M12A05-08-069    | 1000 pcs | 05 Pin               | B-code | M12B05-08-069    | 1000 pcs |
| 06 Pin               | A-code | M12A06-08-069    | 1000 pcs | 02 Pin               | D-code | M12D02-08-069    | 1000 pcs |
| 07 Pin               | A-code | M12A07-08-069    | 1000 pcs | 03 Pin               | D-code | M12D03-08-069    | 1000 pcs |
| 08 Pin               | A-code | M12A08-08-069    | 1000 pcs | 04 Pin               | D-code | M12D04-08-069    | 1000 pcs |

技术参数 / Specifications

| 芯数 / Pin   | 02 Pin                                    | 03 Pin | 04 Pin | 05 Pin | 06 Pin | 07 Pin | 08 Pin |
|--|---|--------|--------|--------|--------|--------|--------|
| 额定电流 / Rated current                                 | 4 A                                       | 4 A    | 4 A    | 4 A    | 2 A    | 2 A    | 2 A    |
| 额定电压 / Rated voltage                                 | 60 V                                      | 60 V   | 60 V   | 60 V   | 30 V   | 30 V   | 30 V   |
| 线规 (mm <sup>2</sup> ) / Wire gauge(mm <sup>2</sup> ) | 0.14mm <sup>2</sup> ~ 0.75mm <sup>2</sup> |        |        |        |        |        |        |
| 线号 (AWG) / Wire gauge(AWG)                           | 26AWG ~ 18AWG                             |        |        |        |        |        |        |
| 标准 / Standard  | IEC 61076-2-101                           |        |        |        |        |        |        |
| 接线方式 / Termination                                   | 焊线 / Solder                               |        |        |        |        |        |        |
| 锁紧方式 / Connect locking system                        | 螺纹锁紧 / Screw Lock                         |        |        |        |        |        |        |
| 防护等级 / Degree of protection                          | IP67 / IP68                               |        |        |        |        |        |        |
| 插拔次数 / Mechanical durability                         | 500次                                      |        |        |        |        |        |        |
| 工作温度 / Operation temperature                         | -25 °C ~ +85 °C                           |        |        |        |        |        |        |
| 接触电阻 / Contact resistance                            | ≤ 10mΩ                                    |        |        |        |        |        |        |
| 绝缘电阻 / Insulation resistance                         | ≥ 1000MΩ                                  |        |        |        |        |        |        |
| 胶芯材料 / Housing material                              | 尼龙PA66                                    |        |        |        |        |        |        |
| 端子材料 / Pin material                                  | 黄铜镀金 / Brass With Gold Plated             |        |        |        |        |        |        |
| 螺丝材料 / Screw   | 黄铜镀镍 / Brass With Nickel Plated           |        |        |        |        |        |        |
| 胶圈材料 / Gasket material                               | 氟胶圈 / Fluorine Ring                       |        |        |        |        |        |        |

## M12成型式线端母头C款 焊线型+10.5L网纹POM螺母

产品图 / Product photo



尺寸图 / Dimension

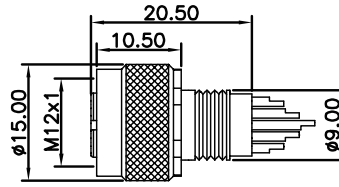

针位分布前视图 / Pin assignment front view

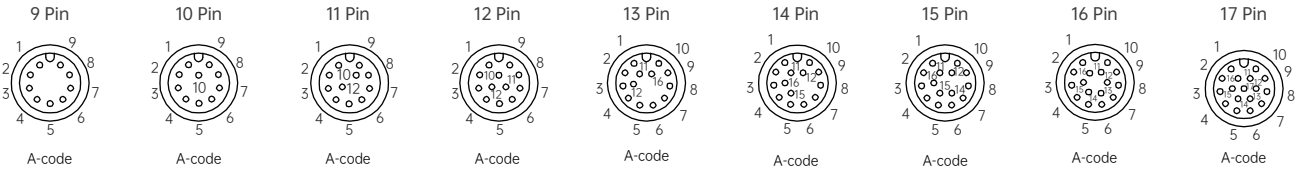

订货信息 / Order daec

| 芯数 / Number of cores | Coding | 料号 / Part number | Qty      |
|----------------------|--------|------------------|----------|
| 09 Pin               | A-code | M12A09-08-070    | 1000 pcs |
| 10 Pin               | A-code | M12A10-08-070    | 1000 pcs |
| 11 Pin               | A-code | M12A11-08-070    | 1000 pcs |
| 12 Pin               | A-code | M12A12-08-070    | 1000 pcs |
| 13 Pin               | A-code | M12A13-08-070    | 1000 pcs |
| 14 Pin               | A-code | M12A14-08-070    | 1000 pcs |
| 15 Pin               | A-code | M12A15-08-070    | 1000 pcs |
| 16 Pin               | A-code | M12A16-08-070    | 1000 pcs |
| 17 Pin               | A-code | M12A17-08-070    | 1000 pcs |

技术参数 / Specifications

| 芯数 / Pin   | 09 Pin                                    | 10 Pin | 11 Pin | 12 Pin | 13 Pin | 14 Pin | 15 Pin | 16 Pin | 17 Pin |
|--|---|--------|--------|--------|--------|--------|--------|--------|--------|
| 额定电流 / Rated current                                 | 1.5 A                                     |        |        |        |        |        |        |        |        |
| 额定电压 / Rated voltage                                 | 30 V                                      |        |        |        |        |        |        |        |        |
| 线规 (mm <sup>2</sup> ) / Wire gauge(mm <sup>2</sup> ) | 0.14mm <sup>2</sup> ~ 0.75mm <sup>2</sup> |        |        |        |        |        |        |        |        |
| 线号 (AWG) / Wire gauge(AWG)                           | 26AWG ~ 18AWG                             |        |        |        |        |        |        |        |        |
| 标准 / Standard  | IEC 61076-2-101                           |        |        |        |        |        |        |        |        |
| 接线方式 / Termination                                   | 焊线 / Solder                               |        |        |        |        |        |        |        |        |
| 锁紧方式 / Connect locking system                        | 螺纹锁紧 / Screw Lock                         |        |        |        |        |        |        |        |        |
| 防护等级 / Degree of protection                          | IP67 / IP68                               |        |        |        |        |        |        |        |        |
| 插拔次数 / Mechanical durability                         | 500次                                      |        |        |        |        |        |        |        |        |
| 工作温度 / Operation temperature                         | -25 °C ~ +85 °C                           |        |        |        |        |        |        |        |        |
| 接触电阻 / Contact resistance                            | ≤ 10mΩ                                    |        |        |        |        |        |        |        |        |
| 绝缘电阻 / Insulation resistance                         | ≥ 1000MΩ                                  |        |        |        |        |        |        |        |        |
| 胶芯材料 / Housing material                              | 尼龙PA66                                    |        |        |        |        |        |        |        |        |
| 端子材料 / Pin material                                  | 黄铜镀金 / Brass With Gold Plated             |        |        |        |        |        |        |        |        |
| 螺丝材料 / Screw   | POM                                       |        |        |        |        |        |        |        |        |
| 胶圈材料 / Gasket material                               | 氟胶圈 / Fluorine Ring                       |        |        |        |        |        |        |        |        |

## M12成型式母头 焊线式 直纹螺丝

产品图 / Product photo



尺寸图 / Dimension

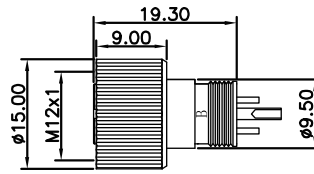

针位分布前视图 / Pin assignment front view

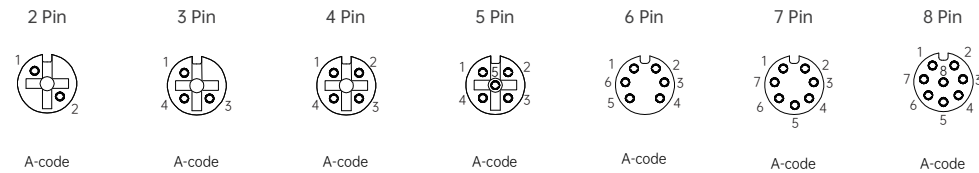

订货信息 / Order daec

| 芯数 / Number of cores | Coding | 料号 / Part number | Qty      |
|----------------------|--------|------------------|----------|
| 02 Pin               | A-code | M12A02-08-081    | 1000 pcs |
| 03 Pin               | A-code | M12A03-08-081    | 1000 pcs |
| 04 Pin               | A-code | M12A04-08-081    | 1000 pcs |
| 05 Pin               | A-code | M12A05-08-081    | 1000 pcs |
| 06 Pin               | A-code | M12A06-08-081    | 1000 pcs |
| 07 Pin               | A-code | M12A07-08-081    | 1000 pcs |
| 08 Pin               | A-code | M12A08-08-081    | 1000 pcs |

技术参数 / Specifications

| 芯数 / Pin   | 02 Pin                                    | 03 Pin | 04 Pin | 05 Pin | 06 Pin | 07 Pin | 08 Pin |
|--|---|--------|--------|--------|--------|--------|--------|
| 额定电流 / Rated current                                 | 4 A                                       | 4 A    | 4 A    | 4 A    | 2 A    | 2 A    | 2 A    |
| 额定电压 / Rated voltage                                 | 60 V                                      | 60 V   | 60 V   | 60 V   | 30 V   | 30 V   | 30 V   |
| 线规 (mm <sup>2</sup> ) / Wire gauge(mm <sup>2</sup> ) | 0.14mm <sup>2</sup> ~ 0.75mm <sup>2</sup> |        |        |        |        |        |        |
| 线号 (AWG) / Wire gauge(AWG)                           | 26AWG ~ 18AWG                             |        |        |        |        |        |        |
| 标准 / Standard  | IEC 61076-2-101                           |        |        |        |        |        |        |
| 接线方式 / Termination                                   | 焊线 / Solder                               |        |        |        |        |        |        |
| 锁紧方式 / Connect locking system                        | 螺纹锁紧 / Screw Lock                         |        |        |        |        |        |        |
| 防护等级 / Degree of protection                          | IP67 / IP68                               |        |        |        |        |        |        |
| 插拔次数 / Mechanical durability                         | 500次                                      |        |        |        |        |        |        |
| 工作温度 / Operation temperature                         | -25 °C ~ +85 °C                           |        |        |        |        |        |        |
| 接触电阻 / Contact resistance                            | ≤ 10mΩ                                    |        |        |        |        |        |        |
| 绝缘电阻 / Insulation resistance                         | ≥ 1000MΩ                                  |        |        |        |        |        |        |
| 胶芯材料 / Housing material                              | 尼龙PA66                                    |        |        |        |        |        |        |
| 端子材料 / Pin material                                  | 黄铜镀金 / Brass With Gold Plated             |        |        |        |        |        |        |
| 螺丝材料 / Screw   | 铝合金黑色/银色 / Al Alloy Black/Silver          |        |        |        |        |        |        |
| 胶圈材料 / Gasket material                               | 氟胶圈 / Fluorine Ring                       |        |        |        |        |        |        |

## M12成型式线端母头B款 焊线式+10.5L防振动六角螺母

产品图 / Product photo



尺寸图 / Dimension

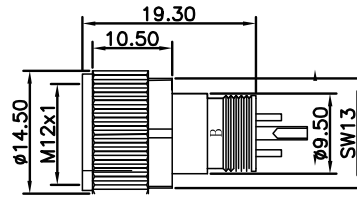

针位分布前视图 / Pin assignment front view

|        | 2 Pin | 3 Pin | 4 Pin | 5 Pin | 6 Pin | 7 Pin | 8 Pin |
|--------|-------|-------|-------|-------|-------|-------|-------|
| A-code |       |       |       |       |       |       |       |
| B-code |       |       |       |       |       |       |       |
| D-code |       |       |       |       |       |       |       |

订货信息 / Order daea

| 芯数 / Number of cores | Coding | 料号 / Part number | Qty      | 芯数 / Number of cores | Coding | 料号 / Part number | Qty      |
|----------------------|--------|------------------|----------|----------------------|--------|------------------|----------|
| 02 Pin               | A-code | M12A02-08-083    | 1000 pcs | 02 Pin               | B-code | M12B02-08-083    | 1000 pcs |
| 03 Pin               | A-code | M12A03-08-083    | 1000 pcs | 03 Pin               | B-code | M12B03-08-083    | 1000 pcs |
| 04 Pin               | A-code | M12A04-08-083    | 1000 pcs | 04 Pin               | B-code | M12B04-08-083    | 1000 pcs |
| 05 Pin               | A-code | M12A05-08-083    | 1000 pcs | 05 Pin               | B-code | M12B05-08-083    | 1000 pcs |
| 06 Pin               | A-code | M12A06-08-083    | 1000 pcs | 02 Pin               | D-code | M12D02-08-083    | 1000 pcs |
| 07 Pin               | A-code | M12A07-08-083    | 1000 pcs | 03 Pin               | D-code | M12D03-08-083    | 1000 pcs |
| 08 Pin               | A-code | M12A08-08-083    | 1000 pcs | 04 Pin               | D-code | M12D04-08-083    | 1000 pcs |

技术参数 / Specifications

| 芯数 / Pin   | 02 Pin                                    | 03 Pin | 04 Pin | 05 Pin | 06 Pin | 07 Pin | 08 Pin |
|--|---|--------|--------|--------|--------|--------|--------|
| 额定电流 / Rated current                                 | 4 A                                       | 4 A    | 4 A    | 4 A    | 2 A    | 2 A    | 2 A    |
| 额定电压 / Rated voltage                                 | 60 V                                      | 60 V   | 60 V   | 60 V   | 30 V   | 30 V   | 30 V   |
| 线规 (mm <sup>2</sup> ) / Wire gauge(mm <sup>2</sup> ) | 0.14mm <sup>2</sup> ~ 0.75mm <sup>2</sup> |        |        |        |        |        |        |
| 线号 (AWG) / Wire gauge(AWG)                           | 26AWG ~ 18AWG                             |        |        |        |        |        |        |
| 标准 / Standard  | IEC 61076-2-101                           |        |        |        |        |        |        |
| 接线方式 / Termination                                   | 焊线 / Solder                               |        |        |        |        |        |        |
| 锁紧方式 / Connect locking system                        | 螺纹锁紧 / Screw Lock                         |        |        |        |        |        |        |
| 防护等级 / Degree of protection                          | IP67 / IP68                               |        |        |        |        |        |        |
| 插拔次数 / Mechanical durability                         | 500次                                      |        |        |        |        |        |        |
| 工作温度 / Operation temperature                         | -25 °C ~ +85 °C                           |        |        |        |        |        |        |
| 接触电阻 / Contact resistance                            | ≤ 10mΩ                                    |        |        |        |        |        |        |
| 绝缘电阻 / Insulation resistance                         | ≥ 1000MΩ                                  |        |        |        |        |        |        |
| 胶芯材料 / Housing material                              | 尼龙PA66                                    |        |        |        |        |        |        |
| 端子材料 / Pin material                                  | 黄铜镀金 / Brass With Gold Plated             |        |        |        |        |        |        |
| 螺丝材料 / Screw   | 黄铜镀镍 / Brass With Nickel Plated           |        |        |        |        |        |        |
| 胶圈材料 / Gasket material                               | 氟胶圈 / Fluorine Ring                       |        |        |        |        |        |        |

## M12成型式线端母头B款 焊线式+10.5L防振动六角螺母

产品图 / Product photo



尺寸图 / Dimension

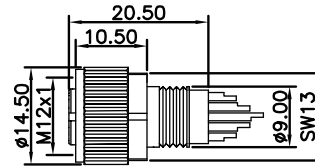

针位分布前视图 / Pin assignment front view

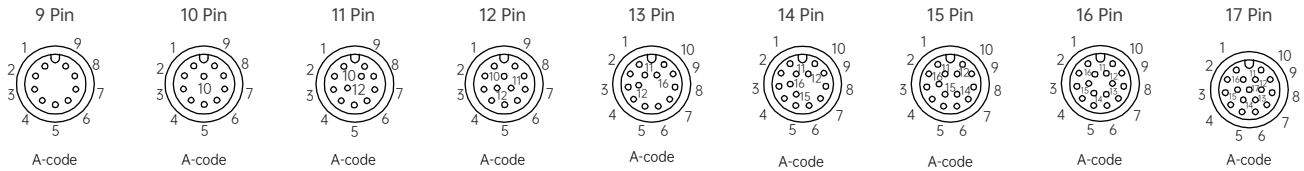

订货信息 / Order daea

| 芯数 / Number of cores | Coding | 料号 / Part number | Qty      |
|----------------------|--------|------------------|----------|
| 09 Pin               | A-code | M12A09-08-084    | 1000 pcs |
| 10 Pin               | A-code | M12A10-08-084    | 1000 pcs |
| 11 Pin               | A-code | M12A11-08-084    | 1000 pcs |
| 12 Pin               | A-code | M12A12-08-084    | 1000 pcs |
| 13 Pin               | A-code | M12A13-08-084    | 1000 pcs |
| 14 Pin               | A-code | M12A14-08-084    | 1000 pcs |
| 15 Pin               | A-code | M12A15-08-084    | 1000 pcs |
| 16 Pin               | A-code | M12A16-08-084    | 1000 pcs |
| 17 Pin               | A-code | M12A17-08-084    | 1000 pcs |

技术参数 / Specifications

| 芯数 / Pin   | 09 Pin                                    | 10 Pin | 11 Pin | 12 Pin | 13 Pin | 14 Pin | 15 Pin | 16 Pin | 17 Pin |
|--|---|--------|--------|--------|--------|--------|--------|--------|--------|
| 额定电流 / Rated current                                 | 1.5 A                                     |        |        |        |        |        |        |        |        |
| 额定电压 / Rated voltage                                 | 30 V                                      |        |        |        |        |        |        |        |        |
| 线规 (mm <sup>2</sup> ) / Wire gauge(mm <sup>2</sup> ) | 0.14mm <sup>2</sup> ~ 0.75mm <sup>2</sup> |        |        |        |        |        |        |        |        |
| 线号 (AWG) / Wire gauge(AWG)                           | 26AWG ~ 18AWG                             |        |        |        |        |        |        |        |        |
| 标准 / Standard  | IEC 61076-2-101                           |        |        |        |        |        |        |        |        |
| 接线方式 / Termination                                   | 焊线 / Solder                               |        |        |        |        |        |        |        |        |
| 锁紧方式 / Connect locking system                        | 螺纹锁紧 / Screw Lock                         |        |        |        |        |        |        |        |        |
| 防护等级 / Degree of protection                          | IP67 / IP68                               |        |        |        |        |        |        |        |        |
| 插拔次数 / Mechanical durability                         | 500次                                      |        |        |        |        |        |        |        |        |
| 工作温度 / Operation temperature                         | -25 °C ~ +85 °C                           |        |        |        |        |        |        |        |        |
| 接触电阻 / Contact resistance                            | ≤ 10mΩ                                    |        |        |        |        |        |        |        |        |
| 绝缘电阻 / Insulation resistance                         | ≥ 1000MΩ                                  |        |        |        |        |        |        |        |        |
| 胶芯材料 / Housing material                              | 尼龙PA66                                    |        |        |        |        |        |        |        |        |
| 端子材料 / Pin material                                  | 黄铜镀金 / Brass With Gold Plated             |        |        |        |        |        |        |        |        |
| 螺丝材料 / Screw   | 黄铜镀镍 / Brass With Nickel Plated           |        |        |        |        |        |        |        |        |

## M12成型式线端母头B款 焊线式+10.5L网纹螺母

产品图 / Product photo



尺寸图 / Dimension

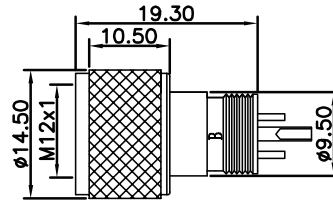

针位分布前视图 / Pin assignment front view

|        | 2 Pin | 3 Pin | 4 Pin | 5 Pin | 6 Pin | 7 Pin | 8 Pin |
|--------|-------|-------|-------|-------|-------|-------|-------|
| A-code |       |       |       |       |       |       |       |
| B-code |       |       |       |       |       |       |       |
| D-code |       |       |       |       |       |       |       |

订货信息 / Order daea

| 芯数 / Number of cores | Coding | 料号 / Part number | Qty      | 芯数 / Number of cores | Coding | 料号 / Part number | Qty      |
|----------------------|--------|------------------|----------|----------------------|--------|------------------|----------|
| 02 Pin               | A-code | M12A02-08-085    | 1000 pcs | 02 Pin               | B-code | M12B02-08-085    | 1000 pcs |
| 03 Pin               | A-code | M12A03-08-085    | 1000 pcs | 03 Pin               | B-code | M12B03-08-085    | 1000 pcs |
| 04 Pin               | A-code | M12A04-08-085    | 1000 pcs | 04 Pin               | B-code | M12B04-08-085    | 1000 pcs |
| 05 Pin               | A-code | M12A05-08-085    | 1000 pcs | 05 Pin               | B-code | M12B05-08-085    | 1000 pcs |
| 06 Pin               | A-code | M12A06-08-085    | 1000 pcs | 02 Pin               | D-code | M12D02-08-085    | 1000 pcs |
| 07 Pin               | A-code | M12A07-08-085    | 1000 pcs | 03 Pin               | D-code | M12D03-08-085    | 1000 pcs |
| 08 Pin               | A-code | M12A08-08-085    | 1000 pcs | 04 Pin               | D-code | M12D04-08-085    | 1000 pcs |

技术参数 / Specifications

| 芯数 / Pin   | 02 Pin                                    | 03 Pin | 04 Pin | 05 Pin | 06 Pin | 07 Pin | 08 Pin |
|--|---|--------|--------|--------|--------|--------|--------|
| 额定电流 / Rated current                                 | 4 A                                       | 4 A    | 4 A    | 4 A    | 2 A    | 2 A    | 2 A    |
| 额定电压 / Rated voltage                                 | 60 V                                      | 60 V   | 60 V   | 60 V   | 30 V   | 30 V   | 30 V   |
| 线规 (mm <sup>2</sup> ) / Wire gauge(mm <sup>2</sup> ) | 0.14mm <sup>2</sup> ~ 0.75mm <sup>2</sup> |        |        |        |        |        |        |
| 线号 (AWG) / Wire gauge(AWG)                           | 26AWG ~ 18AWG                             |        |        |        |        |        |        |
| 标准 / Standard  | IEC 61076-2-101                           |        |        |        |        |        |        |
| 接线方式 / Termination                                   | 焊线 / Solder                               |        |        |        |        |        |        |
| 锁紧方式 / Connect locking system                        | 螺纹锁紧 / Screw Lock                         |        |        |        |        |        |        |
| 防护等级 / Degree of protection                          | IP67 / IP68                               |        |        |        |        |        |        |
| 插拔次数 / Mechanical durability                         | 500次                                      |        |        |        |        |        |        |
| 工作温度 / Operation temperature                         | -25 °C ~ +85 °C                           |        |        |        |        |        |        |
| 接触电阻 / Contact resistance                            | ≤ 10mΩ                                    |        |        |        |        |        |        |
| 绝缘电阻 / Insulation resistance                         | ≥ 1000MΩ                                  |        |        |        |        |        |        |
| 胶芯材料 / Housing material                              | 尼龙PA66                                    |        |        |        |        |        |        |
| 端子材料 / Pin material                                  | 黄铜镀金 / Brass With Gold Plated             |        |        |        |        |        |        |
| 螺丝材料 / Screw   | 黄铜镀镍 / Brass With Nickel Plated           |        |        |        |        |        |        |
| 胶圈材料 / Gasket material                               | 氟胶圈 / Fluorine Ring                       |        |        |        |        |        |        |

## M12成型式线端母头C款 焊线式+10.5L网纹螺母

产品图 / Product photo



尺寸图 / Dimension

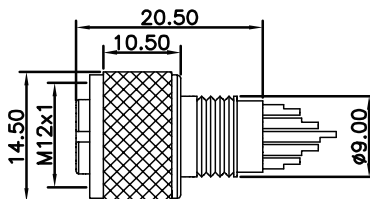

针位分布前视图 / Pin assignment front view

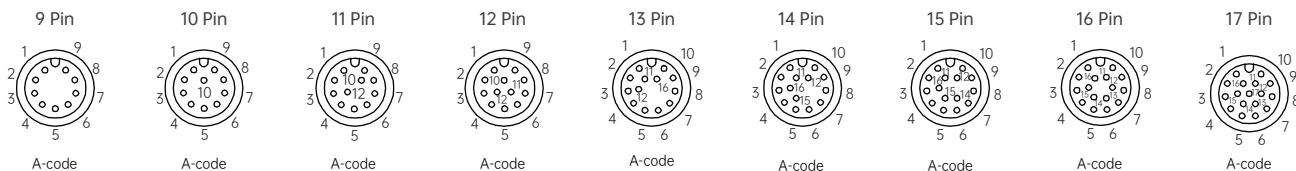

订货信息 / Order daec

| 芯数 / Number of cores | Coding | 料号 / Part number | Qty      |
|----------------------|--------|------------------|----------|
| 09 Pin               | A-code | M12A09-08-086    | 1000 pcs |
| 10 Pin               | A-code | M12A10-08-086    | 1000 pcs |
| 11 Pin               | A-code | M12A11-08-086    | 1000 pcs |
| 12 Pin               | A-code | M12A12-08-086    | 1000 pcs |
| 13 Pin               | A-code | M12A13-08-086    | 1000 pcs |
| 14 Pin               | A-code | M12A14-08-086    | 1000 pcs |
| 15 Pin               | A-code | M12A15-08-086    | 1000 pcs |
| 16 Pin               | A-code | M12A16-08-086    | 1000 pcs |
| 17 Pin               | A-code | M12A17-08-086    | 1000 pcs |

技术参数 / Specifications

| 芯数 / Pin   | 09 Pin                                    | 10 Pin | 11 Pin | 12 Pin | 13 Pin | 14 Pin | 15 Pin | 16 Pin | 17 Pin |
|--|---|--------|--------|--------|--------|--------|--------|--------|--------|
| 额定电流 / Rated current                                 | 1.5 A                                     |        |        |        |        |        |        |        |        |
| 额定电压 / Rated voltage                                 | 30 V                                      |        |        |        |        |        |        |        |        |
| 线规 (mm <sup>2</sup> ) / Wire gauge(mm <sup>2</sup> ) | 0.14mm <sup>2</sup> ~ 0.75mm <sup>2</sup> |        |        |        |        |        |        |        |        |
| 线号 (AWG) / Wire gauge(AWG)                           | 26AWG ~ 18AWG                             |        |        |        |        |        |        |        |        |
| 标准 / Standard  | IEC 61076-2-101                           |        |        |        |        |        |        |        |        |
| 接线方式 / Termination                                   | 焊线 / Solder                               |        |        |        |        |        |        |        |        |
| 锁紧方式 / Connect locking system                        | 螺纹锁紧 / Screw Lock                         |        |        |        |        |        |        |        |        |
| 防护等级 / Degree of protection                          | IP67 / IP68                               |        |        |        |        |        |        |        |        |
| 插拔次数 / Mechanical durability                         | 500次                                      |        |        |        |        |        |        |        |        |
| 工作温度 / Operation temperature                         | -25 °C ~ +85 °C                           |        |        |        |        |        |        |        |        |
| 接触电阻 / Contact resistance                            | ≤ 10mΩ                                    |        |        |        |        |        |        |        |        |
| 绝缘电阻 / Insulation resistance                         | ≥ 1000MΩ                                  |        |        |        |        |        |        |        |        |
| 胶芯材料 / Housing material                              | 尼龙PA66                                    |        |        |        |        |        |        |        |        |
| 端子材料 / Pin material                                  | 黄铜镀金 / Brass With Gold Plated             |        |        |        |        |        |        |        |        |
| 螺丝材料 / Screw   | 黄铜镀镍 / Brass With Nickel Plated           |        |        |        |        |        |        |        |        |
| 胶圈材料 / Gasket material                               | 氟胶圈 / Fluorine Ring                       |        |        |        |        |        |        |        |        |



## M12成型式线端母头B款 焊线式+10.4L六角螺母

产品图 / Product photo



尺寸图 / Dimension

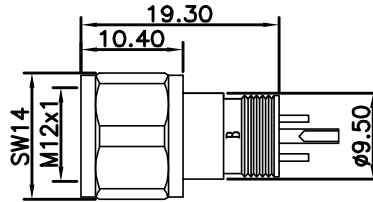

针位分布前视图 / Pin assignment front view

|        | 2 Pin | 3 Pin | 4 Pin | 5 Pin | 6 Pin | 7 Pin | 8 Pin |
|--------|-------|-------|-------|-------|-------|-------|-------|
| A-code |       |       |       |       |       |       |       |
| B-code |       |       |       |       |       |       |       |
| D-code |       |       |       |       |       |       |       |

订货信息 / Order daea

| 芯数 / Number of cores | Coding | 料号 / Part number | Qty      | 芯数 / Number of cores | Coding | 料号 / Part number | Qty      |
|----------------------|--------|------------------|----------|----------------------|--------|------------------|----------|
| 02 Pin               | A-code | M12A02-08-087    | 1000 pcs | 02 Pin               | B-code | M12B02-08-087    | 1000 pcs |
| 03 Pin               | A-code | M12A03-08-087    | 1000 pcs | 03 Pin               | B-code | M12B03-08-087    | 1000 pcs |
| 04 Pin               | A-code | M12A04-08-087    | 1000 pcs | 04 Pin               | B-code | M12B04-08-087    | 1000 pcs |
| 05 Pin               | A-code | M12A05-08-087    | 1000 pcs | 05 Pin               | B-code | M12B05-08-087    | 1000 pcs |
| 06 Pin               | A-code | M12A06-08-087    | 1000 pcs | 02 Pin               | D-code | M12D02-08-087    | 1000 pcs |
| 07 Pin               | A-code | M12A07-08-087    | 1000 pcs | 03 Pin               | D-code | M12D03-08-087    | 1000 pcs |
| 08 Pin               | A-code | M12A08-08-087    | 1000 pcs | 04 Pin               | D-code | M12D04-08-087    | 1000 pcs |

技术参数 / Specifications

| 芯数 / Pin   | 02 Pin                                    | 03 Pin | 04 Pin | 05 Pin | 06 Pin | 07 Pin | 08 Pin |
|--|---|--------|--------|--------|--------|--------|--------|
| 额定电流 / Rated current                                 | 4 A                                       | 4 A    | 4 A    | 4 A    | 2 A    | 2 A    | 2 A    |
| 额定电压 / Rated voltage                                 | 60 V                                      | 60 V   | 60 V   | 60 V   | 30 V   | 30 V   | 30 V   |
| 线规 (mm <sup>2</sup> ) / Wire gauge(mm <sup>2</sup> ) | 0.14mm <sup>2</sup> ~ 0.75mm <sup>2</sup> |        |        |        |        |        |        |
| 线号 (AWG) / Wire gauge(AWG)                           | 26AWG ~ 18AWG                             |        |        |        |        |        |        |
| 标准 / Standard  | IEC 61076-2-101                           |        |        |        |        |        |        |
| 接线方式 / Termination                                   | 焊线 / Solder                               |        |        |        |        |        |        |
| 锁紧方式 / Connect locking system                        | 螺纹锁紧 / Screw Lock                         |        |        |        |        |        |        |
| 防护等级 / Degree of protection                          | IP67 / IP68                               |        |        |        |        |        |        |
| 插拔次数 / Mechanical durability                         | 500次                                      |        |        |        |        |        |        |
| 工作温度 / Operation temperature                         | -25 °C ~ +85 °C                           |        |        |        |        |        |        |
| 接触电阻 / Contact resistance                            | ≤ 10mΩ                                    |        |        |        |        |        |        |
| 绝缘电阻 / Insulation resistance                         | ≥ 1000MΩ                                  |        |        |        |        |        |        |
| 胶芯材料 / Housing material                              | 尼龙PA66                                    |        |        |        |        |        |        |
| 端子材料 / Pin material                                  | 黄铜镀金 / Brass With Gold Plated             |        |        |        |        |        |        |
| 螺丝材料 / Screw   | 黄铜镀镍 / Brass With Nickel Plated           |        |        |        |        |        |        |
| 胶圈材料 / Gasket material                               | 氟胶圈 / Fluorine Ring                       |        |        |        |        |        |        |

## M12成型式线端母头C款 焊线型+10.4L六角螺母

产品图 / Product photo



尺寸图 / Dimension

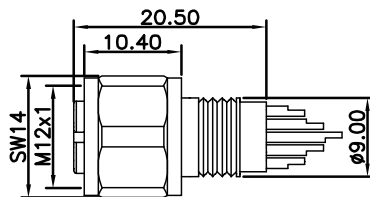

针位分布前视图 / Pin assignment front view

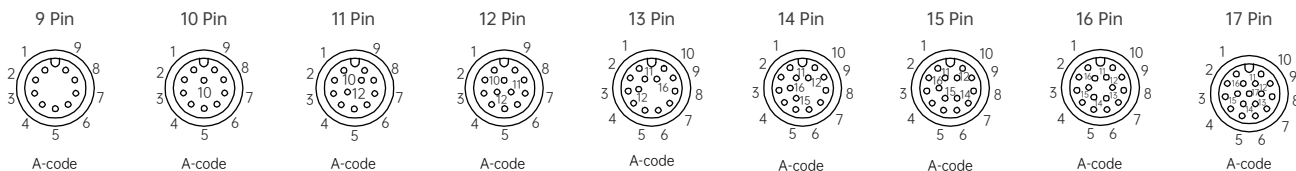

订货信息 / Order daec

| 芯数 / Number of cores | Coding | 料号 / Part number | Qty      |
|----------------------|--------|------------------|----------|
| 09 Pin               | A-code | M12A09-08-088    | 1000 pcs |
| 10 Pin               | A-code | M12A10-08-088    | 1000 pcs |
| 11 Pin               | A-code | M12A11-08-088    | 1000 pcs |
| 12 Pin               | A-code | M12A12-08-088    | 1000 pcs |
| 13 Pin               | A-code | M12A13-08-088    | 1000 pcs |
| 14 Pin               | A-code | M12A14-08-088    | 1000 pcs |
| 15 Pin               | A-code | M12A15-08-088    | 1000 pcs |
| 16 Pin               | A-code | M12A16-08-088    | 1000 pcs |
| 17 Pin               | A-code | M12A17-08-088    | 1000 pcs |

技术参数 / Specifications

| 芯数 / Pin   | 09 Pin                                    | 10 Pin | 11 Pin | 12 Pin | 13 Pin | 14 Pin | 15 Pin | 16 Pin | 17 Pin |
|--|---|--------|--------|--------|--------|--------|--------|--------|--------|
| 额定电流 / Rated current                                 | 1.5 A                                     |        |        |        |        |        |        |        |        |
| 额定电压 / Rated voltage                                 | 30 V                                      |        |        |        |        |        |        |        |        |
| 线规 (mm <sup>2</sup> ) / Wire gauge(mm <sup>2</sup> ) | 0.14mm <sup>2</sup> ~ 0.75mm <sup>2</sup> |        |        |        |        |        |        |        |        |
| 线号 (AWG) / Wire gauge(AWG)                           | 26AWG ~ 18AWG                             |        |        |        |        |        |        |        |        |
| 标准 / Standard  | IEC 61076-2-101                           |        |        |        |        |        |        |        |        |
| 接线方式 / Termination                                   | 焊线 / Solder                               |        |        |        |        |        |        |        |        |
| 锁紧方式 / Connect locking system                        | 螺纹锁紧 / Screw Lock                         |        |        |        |        |        |        |        |        |
| 防护等级 / Degree of protection                          | IP67 / IP68                               |        |        |        |        |        |        |        |        |
| 插拔次数 / Mechanical durability                         | 500次                                      |        |        |        |        |        |        |        |        |
| 工作温度 / Operation temperature                         | -25 °C ~ +85 °C                           |        |        |        |        |        |        |        |        |
| 接触电阻 / Contact resistance                            | ≤ 10mΩ                                    |        |        |        |        |        |        |        |        |
| 绝缘电阻 / Insulation resistance                         | ≥ 1000MΩ                                  |        |        |        |        |        |        |        |        |
| 胶芯材料 / Housing material                              | 尼龙PA66                                    |        |        |        |        |        |        |        |        |
| 端子材料 / Pin material                                  | 黄铜镀金 / Brass With Gold Plated             |        |        |        |        |        |        |        |        |
| 螺丝材料 / Screw   | 黄铜镀镍 / Brass With Nickel Plated           |        |        |        |        |        |        |        |        |
| 胶圈材料 / Gasket material                               | 氟胶圈 / Fluorine Ring                       |        |        |        |        |        |        |        |        |

## M12成型式线端母头 焊线型屏蔽款+10.0L直纹螺母

产品图 / Product photo



尺寸图 / Dimension

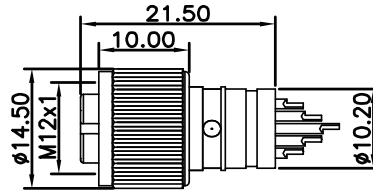

针位分布前视图 / Pin assignment front view

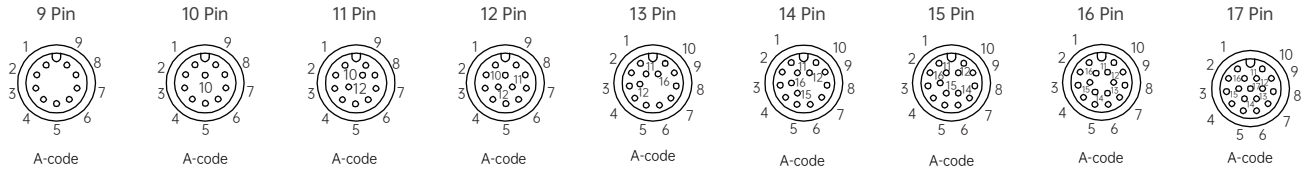

订货信息 / Order daec

| 芯数 / Number of cores | Coding | 料号 / Part number | Qty      |
|----------------------|--------|------------------|----------|
| 09 Pin               | A-code | M12A09-08-103    | 1000 pcs |
| 10 Pin               | A-code | M12A10-08-103    | 1000 pcs |
| 11 Pin               | A-code | M12A11-08-103    | 1000 pcs |
| 12 Pin               | A-code | M12A12-08-103    | 1000 pcs |
| 13 Pin               | A-code | M12A13-08-103    | 1000 pcs |
| 14 Pin               | A-code | M12A14-08-103    | 1000 pcs |
| 15 Pin               | A-code | M12A15-08-103    | 1000 pcs |
| 16 Pin               | A-code | M12A16-08-103    | 1000 pcs |
| 17 Pin               | A-code | M12A17-08-103    | 1000 pcs |

技术参数 / Specifications

| 芯数 / Pin   | 09 Pin                                    | 10 Pin | 11 Pin | 12 Pin | 13 Pin | 14 Pin | 15 Pin | 16 Pin | 17 Pin |
|--|---|--------|--------|--------|--------|--------|--------|--------|--------|
| 额定电流 / Rated current                                 | 1.5 A                                     |        |        |        |        |        |        |        |        |
| 额定电压 / Rated voltage                                 | 30 V                                      |        |        |        |        |        |        |        |        |
| 线规 (mm <sup>2</sup> ) / Wire gauge(mm <sup>2</sup> ) | 0.14mm <sup>2</sup> ~ 0.75mm <sup>2</sup> |        |        |        |        |        |        |        |        |
| 线号 (AWG) / Wire gauge(AWG)                           | 26AWG ~ 18AWG                             |        |        |        |        |        |        |        |        |
| 标准 / Standard  | IEC 61076-2-101                           |        |        |        |        |        |        |        |        |
| 接线方式 / Termination                                   | 焊线 / Solder                               |        |        |        |        |        |        |        |        |
| 锁紧方式 / Connect locking system                        | 螺纹锁紧 / Screw Lock                         |        |        |        |        |        |        |        |        |
| 防护等级 / Degree of protection                          | IP67 / IP68                               |        |        |        |        |        |        |        |        |
| 插拔次数 / Mechanical durability                         | 500次                                      |        |        |        |        |        |        |        |        |
| 工作温度 / Operation temperature                         | -25 °C ~ +85 °C                           |        |        |        |        |        |        |        |        |
| 接触电阻 / Contact resistance                            | ≤ 10mΩ                                    |        |        |        |        |        |        |        |        |
| 绝缘电阻 / Insulation resistance                         | ≥ 1000MΩ                                  |        |        |        |        |        |        |        |        |
| 胶芯材料 / Housing material                              | 尼龙PA66                                    |        |        |        |        |        |        |        |        |
| 端子材料 / Pin material                                  | 黄铜镀金 / Brass With Gold Plated             |        |        |        |        |        |        |        |        |
| 螺丝材料 / Screw   | 黄铜镀镍 / Brass With Nickel Plated           |        |        |        |        |        |        |        |        |
| 胶圈材料 / Gasket material                               | 氟胶圈 / Fluorine Ring                       |        |        |        |        |        |        |        |        |
| 屏蔽罩材料 / Shielded shell material                      | 黄铜镀镍 / Brass With Nickel Plated           |        |        |        |        |        |        |        |        |

## M12成型式线端母头 焊线型10.5L直纹螺母

产品图 / Product photo



尺寸图 / Dimension

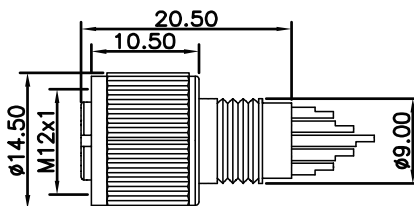

针位分布前视图 / Pin assignment front view

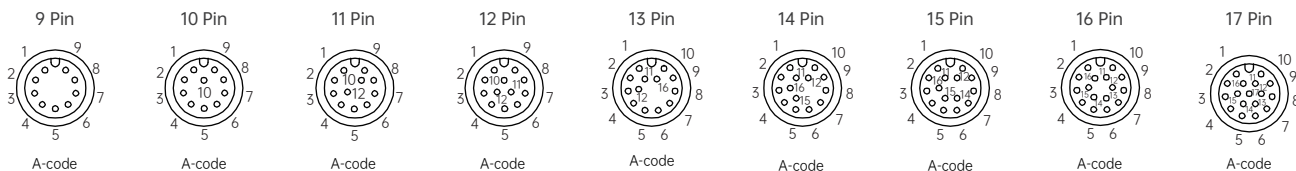

订货信息 / Order daec

| 芯数 / Number of cores | Coding | 料号 / Part number | Qty      |
|----------------------|--------|------------------|----------|
| 09 Pin               | A-code | M12A09-08-101    | 1000 pcs |
| 10 Pin               | A-code | M12A10-08-101    | 1000 pcs |
| 11 Pin               | A-code | M12A11-08-101    | 1000 pcs |
| 12 Pin               | A-code | M12A12-08-101    | 1000 pcs |
| 13 Pin               | A-code | M12A13-08-101    | 1000 pcs |
| 14 Pin               | A-code | M12A14-08-101    | 1000 pcs |
| 15 Pin               | A-code | M12A15-08-101    | 1000 pcs |
| 16 Pin               | A-code | M12A16-08-101    | 1000 pcs |
| 17 Pin               | A-code | M12A17-08-101    | 1000 pcs |

技术参数 / Specifications

| 芯数 / Pin   | 09 Pin                                    | 10 Pin | 11 Pin | 12 Pin | 13 Pin | 14 Pin | 15 Pin | 16 Pin | 17 Pin |
|--|---|--------|--------|--------|--------|--------|--------|--------|--------|
| 额定电流 / Rated current                                 | 1.5 A                                     |        |        |        |        |        |        |        |        |
| 额定电压 / Rated voltage                                 | 30 V                                      |        |        |        |        |        |        |        |        |
| 线规 (mm <sup>2</sup> ) / Wire gauge(mm <sup>2</sup> ) | 0.14mm <sup>2</sup> ~ 0.75mm <sup>2</sup> |        |        |        |        |        |        |        |        |
| 线号 (AWG) / Wire gauge(AWG)                           | 26AWG ~ 18AWG                             |        |        |        |        |        |        |        |        |
| 标准 / Standard  | IEC 61076-2-101                           |        |        |        |        |        |        |        |        |
| 接线方式 / Termination                                   | 焊线 / Solder                               |        |        |        |        |        |        |        |        |
| 锁紧方式 / Connect locking system                        | 螺纹锁紧 / Screw Lock                         |        |        |        |        |        |        |        |        |
| 防护等级 / Degree of protection                          | IP67 / IP68                               |        |        |        |        |        |        |        |        |
| 插拔次数 / Mechanical durability                         | 500次                                      |        |        |        |        |        |        |        |        |
| 工作温度 / Operation temperature                         | -25 °C ~ +85 °C                           |        |        |        |        |        |        |        |        |
| 接触电阻 / Contact resistance                            | ≤ 5mΩ                                     |        |        |        |        |        |        |        |        |
| 绝缘电阻 / Insulation resistance                         | ≥ 1000MΩ                                  |        |        |        |        |        |        |        |        |
| 胶芯材料 / Housing material                              | 尼龙PA66                                    |        |        |        |        |        |        |        |        |
| 端子材料 / Pin material                                  | 黄铜镀金 / Brass With Gold Plated             |        |        |        |        |        |        |        |        |
| 螺丝材料 / Screw   | 黄铜镀镍 / Brass With Nickel Plated           |        |        |        |        |        |        |        |        |
| 胶圈材料 / Gasket material                               | 氟胶圈 / Fluorine Ring                       |        |        |        |        |        |        |        |        |

## M12成型式线端母头 焊线型10.5L网纹螺母

产品图 / Product photo



尺寸图 / Dimension

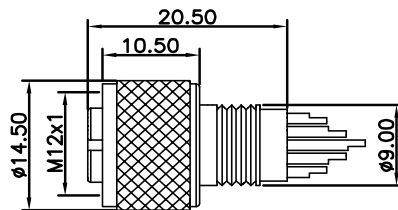

针位分布前视图 / Pin assignment front view

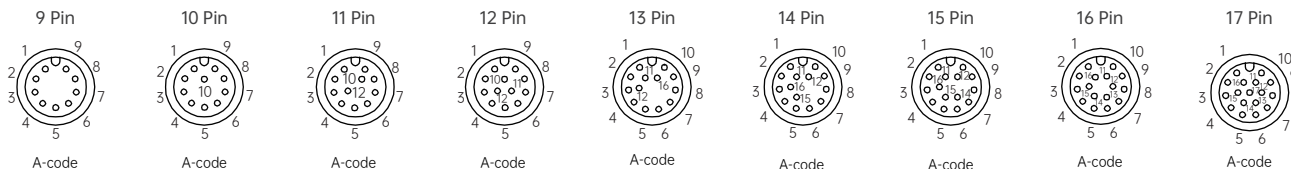

订货信息 / Order daea

| 芯数 / Number of cores | Coding | 料号 / Part number | Qty      |
|----------------------|--------|------------------|----------|
| 09 Pin               | A-code | M12A09-08-102    | 1000 pcs |
| 10 Pin               | A-code | M12A10-08-102    | 1000 pcs |
| 11 Pin               | A-code | M12A11-08-102    | 1000 pcs |
| 12 Pin               | A-code | M12A12-08-102    | 1000 pcs |
| 13 Pin               | A-code | M12A13-08-102    | 1000 pcs |
| 14 Pin               | A-code | M12A14-08-102    | 1000 pcs |
| 15 Pin               | A-code | M12A15-08-102    | 1000 pcs |
| 16 Pin               | A-code | M12A16-08-102    | 1000 pcs |
| 17 Pin               | A-code | M12A17-08-102    | 1000 pcs |

技术参数 / Specifications

| 芯数 / Pin   | 09 Pin                                    | 10 Pin | 11 Pin | 12 Pin | 13 Pin | 14 Pin | 15 Pin | 16 Pin | 17 Pin |
|--|---|--------|--------|--------|--------|--------|--------|--------|--------|
| 额定电流 / Rated current                                 | 1.5 A                                     |        |        |        |        |        |        |        |        |
| 额定电压 / Rated voltage                                 | 30 V                                      |        |        |        |        |        |        |        |        |
| 线规 (mm <sup>2</sup> ) / Wire gauge(mm <sup>2</sup> ) | 0.14mm <sup>2</sup> ~ 0.75mm <sup>2</sup> |        |        |        |        |        |        |        |        |
| 线号 (AWG) / Wire gauge(AWG)                           | 26AWG ~ 18AWG                             |        |        |        |        |        |        |        |        |
| 标准 / Standard  | IEC 61076-2-101                           |        |        |        |        |        |        |        |        |
| 接线方式 / Termination                                   | 焊线 / Solder                               |        |        |        |        |        |        |        |        |
| 锁紧方式 / Connect locking system                        | 螺纹锁紧 / Screw Lock                         |        |        |        |        |        |        |        |        |
| 防护等级 / Degree of protection                          | IP67 / IP68                               |        |        |        |        |        |        |        |        |
| 插拔次数 / Mechanical durability                         | 500次                                      |        |        |        |        |        |        |        |        |
| 工作温度 / Operation temperature                         | -25 °C ~ +85 °C                           |        |        |        |        |        |        |        |        |
| 接触电阻 / Contact resistance                            | ≤ 5mΩ                                     |        |        |        |        |        |        |        |        |
| 绝缘电阻 / Insulation resistance                         | > 1000MΩ                                  |        |        |        |        |        |        |        |        |
| 胶芯材料 / Housing material                              | 尼龙PA66                                    |        |        |        |        |        |        |        |        |
| 端子材料 / Pin material                                  | 黄铜镀金 / Brass With Gold Plated             |        |        |        |        |        |        |        |        |
| 螺丝材料 / Screw   | 黄铜镀镍 / Brass With Nickel Plated           |        |        |        |        |        |        |        |        |
| 胶圈材料 / Gasket material                               | 氟胶圈 / Fluorine Ring                       |        |        |        |        |        |        |        |        |

## M12成型式线端母头 L编码焊线型+10.5L网纹螺母

产品图 / Product photo



尺寸图 / Dimension

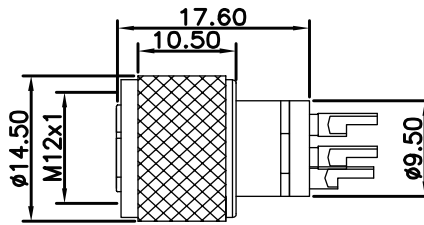

针位分布前视图 / Pin assignment front view

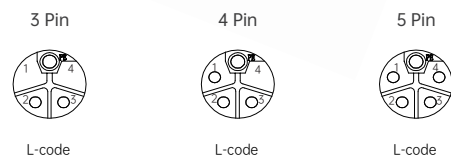

订货信息 / Order daec

| 芯数 / Number of cores | Coding | 料号 / Part number | Qty      |
|----------------------|--------|------------------|----------|
| 03 Pin               | L-code | M12L03-08-105    | 1000 pcs |
| 04 Pin               | L-code | M12L04-08-105    | 1000 pcs |
| 05 Pin               | L-code | M12L05-08-105    | 1000 pcs |

技术参数 / Specifications

| 芯数 / Pin   | 03 Pin | 04 Pin                                    | 05 Pin |
|--|--------|---|--------|
| 额定电流 / Rated current                                 |        | 16 A                                      |        |
| 额定电压 / Rated voltage                                 |        | 63 V                                      |        |
| 线规 (mm <sup>2</sup> ) / Wire gauge(mm <sup>2</sup> ) |        | 0.14mm <sup>2</sup> ~ 0.75mm <sup>2</sup> |        |
| 线号 (AWG) / Wire gauge(AWG)                           |        | 26AWG ~ 18AWG                             |        |
| 标准 / Standard  |        | IEC 61076-2-101                           |        |
| 接线方式 / Termination                                   |        | 焊线 / Solder                               |        |
| 锁紧方式 / Connect locking system                        |        | 螺纹锁紧 / Screw Lock                         |        |
| 防护等级 / Degree of protection                          |        | IP67 / IP68                               |        |
| 插拔次数 / Mechanical durability                         |        | 500次                                      |        |
| 工作温度 / Operation temperature                         |        | -25 °C ~ +85 °C                           |        |
| 接触电阻 / Contact resistance                            |        | ≤ 5mΩ                                     |        |
| 绝缘电阻 / Insulation resistance                         |        | ≥ 1000MΩ                                  |        |
| 胶芯材料 / Housing material                              |        | 尼龙PA66                                    |        |
| 端子材料 / Pin material                                  |        | 黄铜镀金 / Brass With Gold Plated             |        |
| 螺丝材料 / Screw   |        | 黄铜镀镍 / Brass With Nickel Plated           |        |
| 胶圈材料 / Gasket material                               |        | 氟胶圈 / Fluorine Ring                       |        |

## M12成型式线端母头 T编码焊线型+10.5L网纹螺母

产品图 / Product photo



尺寸图 / Dimension

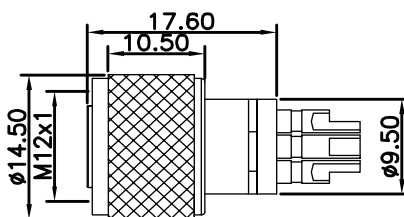

针位分布前视图 / Pin assignment front view

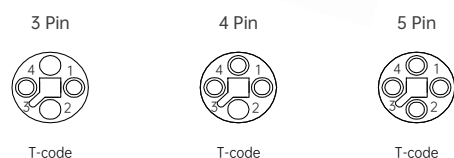

订货信息 / Order daea

| 芯数 / Number of cores | Coding | 料号 / Part number | Qty      |
|----------------------|--------|------------------|----------|
| 03 Pin               | T-code | M12T03-08-107    | 1000 pcs |
| 04 Pin               | T-code | M12T04-08-107    | 1000 pcs |
| 05 Pin               | T-code | M12T05-08-107    | 1000 pcs |

技术参数 / Specifications

| 芯数 / Pin   | 03 Pin | 04 Pin                                    | 05 Pin |
|--|--------|---|--------|
| 额定电流 / Rated current                                 |        | 12 A                                      |        |
| 额定电压 / Rated voltage                                 |        | 50V/63 V                                  |        |
| 线规 (mm <sup>2</sup> ) / Wire gauge(mm <sup>2</sup> ) |        | 0.14mm <sup>2</sup> ~ 0.75mm <sup>2</sup> |        |
| 线号 (AWG) / Wire gauge(AWG)                           |        | 26AWG ~ 18AWG                             |        |
| 标准 / Standard  |        | IEC 61076-2-101                           |        |
| 接线方式 / Termination                                   |        | 焊线 / Solder                               |        |
| 锁紧方式 / Connect locking system                        |        | 螺纹锁紧 / Screw Lock                         |        |
| 防护等级 / Degree of protection                          |        | IP67 / IP68                               |        |
| 插拔次数 / Mechanical durability                         |        | 500次                                      |        |
| 工作温度 / Operation temperature                         |        | -25 °C ~ +85 °C                           |        |
| 接触电阻 / Contact resistance                            |        | ≤ 5mΩ                                     |        |
| 绝缘电阻 / Insulation resistance                         |        | ≥ 1000MΩ                                  |        |
| 胶芯材料 / Housing material                              |        | 尼龙PA66                                    |        |
| 端子材料 / Pin material                                  |        | 黄铜镀金 / Brass With Gold Plated             |        |
| 螺丝材料 / Screw   |        | 黄铜镀镍 / Brass With Nickel Plated           |        |
| 胶圈材料 / Gasket material                               |        | 氟胶圈 / Fluorine Ring                       |        |

## M12成型式线端母头S编码 焊线型+10.5L网纹螺母

产品图 / Product photo



尺寸图 / Dimension

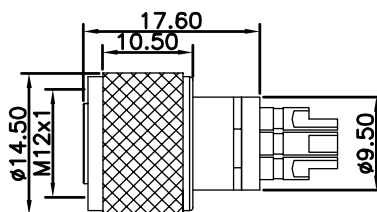

针位分布前视图 / Pin assignment front view

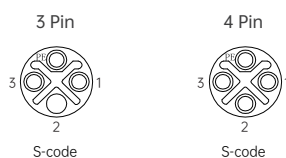

订货信息 / Order daec

| 芯数 / Number of cores | Coding | 料号 / Part number | Qty      |
|----------------------|--------|------------------|----------|
| 03 Pin               | S-code | M12S03-08-108    | 1000 pcs |
| 04 Pin               | S-code | M12S04-08-108    | 1000 pcs |

技术参数 / Specifications

| 芯数 / Pin   | 03 Pin                                    | 04 Pin |
|--|---|--------|
| 额定电流 / Rated current                                 | 12 A                                      |        |
| 额定电压 / Rated voltage                                 | 630 V                                     |        |
| 线规 (mm <sup>2</sup> ) / Wire gauge(mm <sup>2</sup> ) | 0.14mm <sup>2</sup> ~ 0.75mm <sup>2</sup> |        |
| 线号 (AWG) / Wire gauge(AWG)                           | 26AWG ~ 18AWG                             |        |
| 标准 / Standard  | IEC 61076-2-101                           |        |
| 接线方式 / Termination                                   | 焊线 / Solder                               |        |
| 锁紧方式 / Connect locking system                        | 螺纹锁紧 / Screw Lock                         |        |
| 防护等级 / Degree of protection                          | IP67 / IP68                               |        |
| 插拔次数 / Mechanical durability                         | 500次                                      |        |
| 工作温度 / Operation temperature                         | -25 °C ~ +85 °C                           |        |
| 接触电阻 / Contact resistance                            | ≤ 5mΩ                                     |        |
| 绝缘电阻 / Insulation resistance                         | ≥ 1000MΩ                                  |        |
| 胶芯材料 / Housing material                              | 尼龙PA66                                    |        |
| 端子材料 / Pin material                                  | 黄铜镀金 / Brass With Gold Plated             |        |
| 螺丝材料 / Screw   | 黄铜镀镍 / Brass With Nickel Plated           |        |
| 胶圈材料 / Gasket material                               | 氟胶圈 / Fluorine Ring                       |        |



## M12成型式8P线端母头X编码 焊线型+10L直纹螺母

产品图 / Product photo



尺寸图 / Dimension

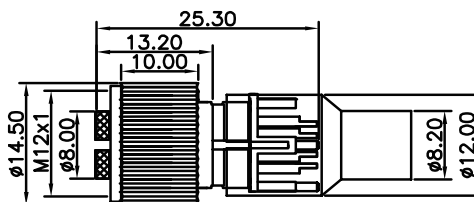

针位分布前视图 / Pin assignment front view



订货信息 / Order daea

| 芯数 / Number of cores | Coding | 料号 / Part number | Qty      |
|----------------------|--------|------------------|----------|
| 08 Pin               | X-code | M12X08-02-027    | 1000 pcs |

技术参数 / Specifications

| 芯数 / Pin   | 08 Pin                                 |
|--|--|
| 额定电流 / Rated current                                 | 0.5 A                                  |
| 额定电压 / Rated voltage                                 | 48 V                                   |
| 线规 (mm <sup>2</sup> ) / Wire gauge(mm <sup>2</sup> ) | 0.14mm <sup>2</sup>                    |
| 线号 (AWG) / Wire gauge(AWG)                           | 26AWG                                  |
| 标准 / Standard  | IEC 61076-2-101                        |
| 接线方式 / Termination                                   | 焊线 / Solder                            |
| 锁紧方式 / Connect locking system                        | 螺纹锁紧 / Screw Lock                      |
| 防护等级 / Degree of protection                          | IP67 / IP68                            |
| 插拔次数 / Mechanical durability                         | 500次                                   |
| 工作温度 / Operation temperature                         | -25 °C ~ +85 °C                        |
| 接触电阻 / Contact resistance                            | ≤ 5mΩ                                  |
| 绝缘电阻 / Insulation resistance                         | > 1000MΩ                               |
| 胶芯材料 / Housing material                              | 尼龙PA66                                 |
| 端子材料 / Pin material                                  | 黄铜镀金 / Brass With Gold Plated          |
| 螺丝材料 / Screw   | 黄铜镀镍 / Brass With Nickel Plated        |
| 胶圈材料 / Gasket material                               | 氟胶圈 / Fluorine Ring                    |
| 屏蔽罩材料 / Shielded shell material                      | 锌合金镀镍 / Zinc Alloys With Nickel Plated |

## M12公直头成型式线束 屏蔽/非屏蔽 线长L可定制

产品图 / Product photo



尺寸图 / Dimension

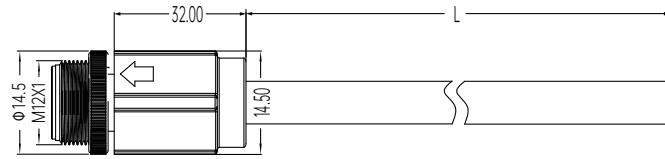

针位分布前视图 / Pin assignment front view

|        | 2 Pin | 3 Pin | 4 Pin | 5 Pin | 6 Pin | 8 Pin | 12 Pin | 17 Pin |
|--------|-------|-------|-------|-------|-------|-------|--------|--------|
| A-code |       |       |       |       |       |       |        |        |
| B-code |       |       |       |       |       |       |        |        |
| D-code |       |       |       |       |       |       |        |        |

订货信息 / Order daea

| 芯数 / Contacts | 编码 / Code | 产品料号("L"表示长度, 单位毫米mm) / Part number ("L" is length millimetre mm) |                   |                   |                   |
|---------------|-----------|---|-------------------|-------------------|-------------------|
|               |           | 1: PVC 无屏蔽  | 2: PUR 无屏蔽        | 3: PVC 带屏蔽        | 4: PUR 带屏蔽        |
| 02 Pin        | A-code    | M12A02-09-010-1-L   | M12A02-09-010-2-L | M12A02-09-010-3-L | M12A02-09-010-4-L |
| 03 Pin        | A-code    | M12A03-09-010-1-L   | M12A03-09-010-2-L | M12A03-09-010-3-L | M12A03-09-010-4-L |
| 04 Pin        | A-code    | M12A04-09-010-1-L   | M12A04-09-010-2-L | M12A04-09-010-3-L | M12A04-09-010-4-L |
| 05 Pin        | A-code    | M12A05-09-010-1-L   | M12A05-09-010-2-L | M12A05-09-010-3-L | M12A05-09-010-4-L |
| 06 Pin        | A-code    | M12A06-09-010-1-L   | M12A06-09-010-2-L | M12A06-09-010-3-L | M12A06-09-010-4-L |
| 08 Pin        | A-code    | M12A08-09-010-1-L   | M12A08-09-010-2-L | M12A08-09-010-3-L | M12A08-09-010-4-L |
| 12 Pin        | A-code    | M12A12-09-010-1-L   | M12A12-09-010-2-L | M12A12-09-010-3-L | M12A12-09-010-4-L |
| 17 Pin        | A-code    | M12A17-09-010-1-L   | M12A17-09-010-2-L | M12A17-09-010-3-L | M12A17-09-010-4-L |
| 02 Pin        | B-code    | M12B02-09-010-1-L   | M12B02-09-010-2-L | M12B02-09-010-3-L | M12B02-09-010-4-L |
| 03 Pin        | B-code    | M12B03-09-010-1-L   | M12B03-09-010-2-L | M12B03-09-010-3-L | M12B03-09-010-4-L |
| 04 Pin        | B-code    | M12B04-09-010-1-L   | M12B04-09-010-2-L | M12B04-09-010-3-L | M12B04-09-010-4-L |
| 05 Pin        | B-code    | M12B05-09-010-1-L   | M12B05-09-010-2-L | M12B05-09-010-3-L | M12B05-09-010-4-L |
| 02 Pin        | D-code    | M12D02-09-010-1-L   | M12D02-09-010-2-L | M12D02-09-010-3-L | M12D02-09-010-4-L |
| 03 Pin        | D-code    | M12D03-09-010-1-L   | M12D03-09-010-2-L | M12D03-09-010-3-L | M12B03-09-010-4-L |
| 04 Pin        | D-code    | M12D04-09-010-1-L   | M12D04-09-010-2-L | M12D04-09-010-3-L | M12B04-09-010-4-L |

技术参数 / Specifications

| 芯数 / Pin                                | 02 Pin  | 03 Pin | 04 Pin | 05 Pin | 06 Pin | 08 Pin | 12 Pin | 17 Pin |
|---|---|--------|--------|--------|--------|--------|--------|--------|
| 编码 / Code                               | A/B/D   | A/B/D  | A/B/D  | A/B    | A      | A      | A      | A      |
| 额定电流 / Rated current                    | 4 A   | 4 A    | 4 A    | 4 A    | 2 A    | 2 A    | 1.5 A  | 1.5 A  |
| 额定电压 / Rated voltage                    | 250 V   | 250 V  | 250 V  | 60 V   | 30 V   | 30 V   | 30 V   | 30 V   |
| 线规 (平方数) / Wire gauge(mm <sup>2</sup> ) | 0.34  | 0.34   | 0.34   | 0.34   | 0.25   | 0.25   | 0.14   | 0.14   |
| 线号 / Wire gauge(AWG)                    | 22  | 22     | 22     | 22     | 24     | 24     | 24     | 24     |
| 标准 / Standard                           | IEC 61076-2-101   |        |        |        |        |        |        |        |
| 接线方式 / Termination                      | 焊接和成型 /Welding And Forming  |        |        |        |        |        |        |        |
| 锁紧方式 / Connect locking system           | 螺纹锁紧 / Screw Lock   |        |        |        |        |        |        |        |
| 防护等级 / Degree of protection             | IP65 / IP67   |        |        |        |        |        |        |        |
| 插拔次数 / Mechanical durability            | 500 次   |        |        |        |        |        |        |        |
| 工作温度 / Operation temperature            | -25 °C ~ +85 °C   |        |        |        |        |        |        |        |
| 阻抗 / Resistance                         | 接触电阻 / Contact Resistance: ≤ 10mΩ 绝缘电阻 / Insulation Resistance: ≥ 1000MΩ  |        |        |        |        |        |        |        |
| 材料 (胶芯/端子/壳体/成型) / Material             | 胶芯: PA+GF/TPU 端子: 黄铜镀金/磷铜镀金 壳体: 黄铜合金镀镍/PA+GF 成型: TPU/PVC<br>Housing: PA+GF/TPU Terminal: Brass With Gold Plated / Phosphor Bronze With Gold Plated<br>shell: Copper Alloy With Nickel Plated/PA+GF Forming: TPU/PVC |        |        |        |        |        |        |        |

联系热线: 400-888-3128

网址: <https://www.dzgu.com>

## M12母直头成型式线束 屏蔽/非屏蔽 线长L可定制

产品图 / Product photo



尺寸图 / Dimension

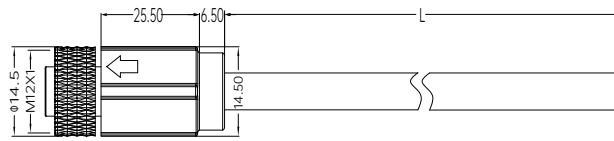

针位分布前视图 / Pin assignment front view

|        | 2 Pin | 3 Pin | 4 Pin | 5 Pin | 6 Pin | 8 Pin | 12 Pin | 17 Pin |
|--------|-------|-------|-------|-------|-------|-------|--------|--------|
| A-code |       |       |       |       |       |       |        |        |
| B-code |       |       |       |       |       |       |        |        |
| D-code |       |       |       |       |       |       |        |        |

订货信息 / Order daea

| 芯数 / Contacts | 编码 / Code | 产品料号("L"表示长度, 单位毫米mm) / Part number ("L" is length millimetre mm) |                   |                   |                   |
|---------------|-----------|---|-------------------|-------------------|-------------------|
|               |           | 1: PVC 无屏蔽  | 2: PUR 无屏蔽        | 3: PVC 带屏蔽        | 4: PUR 带屏蔽        |
| 02 Pin        | A-code    | M12A02-10-010-1-L   | M12A02-10-010-2-L | M12A02-10-010-3-L | M12A02-10-010-4-L |
| 03 Pin        | A-code    | M12A03-10-010-1-L   | M12A03-10-010-2-L | M12A03-10-010-3-L | M12A03-10-010-4-L |
| 04 Pin        | A-code    | M12A04-10-010-1-L   | M12A04-10-010-2-L | M12A04-10-010-3-L | M12A04-10-010-4-L |
| 05 Pin        | A-code    | M12A05-10-010-1-L   | M12A05-10-010-2-L | M12A05-10-010-3-L | M12A05-10-010-4-L |
| 06 Pin        | A-code    | M12A06-10-010-1-L   | M12A06-10-010-2-L | M12A06-10-010-3-L | M12A06-10-010-4-L |
| 08 Pin        | A-code    | M12A08-10-010-1-L   | M12A08-10-010-2-L | M12A08-01-010-3-L | M12A08-10-010-4-L |
| 12 Pin        | A-code    | M12A12-10-010-1-L   | M12A12-10-010-2-L | M12A12-10-010-3-L | M12A12-10-010-4-L |
| 17 Pin        | A-code    | M12A17-10-010-1-L   | M12A17-10-010-2-L | M12A17-10-010-3-L | M12A17-10-010-4-L |
| 02 Pin        | B-code    | M12B02-10-010-1-L   | M12B02-10-010-2-L | M12B02-10-010-3-L | M12B02-10-010-4-L |
| 03 Pin        | B-code    | M12B03-10-010-1-L   | M12B03-10-010-2-L | M12B03-10-010-3-L | M12B03-10-010-4-L |
| 04 Pin        | B-code    | M12B04-10-010-1-L   | M12B04-10-010-2-L | M12B04-10-010-3-L | M12B04-10-010-4-L |
| 05 Pin        | B-code    | M12B05-10-010-1-L   | M12B05-10-010-2-L | M12B05-10-010-3-L | M12B05-10-010-4-L |
| 02 Pin        | D-code    | M12D02-10-010-1-L   | M12D02-10-010-2-L | M12D02-10-010-3-L | M12D02-10-010-4-L |
| 03 Pin        | D-code    | M12D03-10-010-1-L   | M12D03-10-010-2-L | M12D03-10-010-3-L | M12B03-10-010-4-L |
| 04 Pin        | D-code    | M12D04-10-010-1-L   | M12D04-10-010-2-L | M12D04-10-010-3-L | M12B04-10-010-4-L |

技术参数 / Specifications

| 芯数 / Pin                                | 02 Pin  | 03 Pin | 04 Pin | 05 Pin | 06 Pin | 08 Pin | 12 Pin | 17 Pin |
|---|---|--------|--------|--------|--------|--------|--------|--------|
| 编码 / Code                               | A/B/D   | A/B/D  | A/B/D  | A/B    | A      | A      | A      | A      |
| 额定电流 / Rated current                    | 4 A   | 4 A    | 4 A    | 4 A    | 2 A    | 2 A    | 1.5 A  | 1.5 A  |
| 额定电压 / Rated voltage                    | 250 V   | 250 V  | 250 V  | 60 V   | 30 V   | 30 V   | 30 V   | 30 V   |
| 线规 (平方数) / Wire gauge(mm <sup>2</sup> ) | 0.34  | 0.34   | 0.34   | 0.34   | 0.25   | 0.25   | 0.14   | 0.14   |
| 线号 / Wire gauge(AWG)                    | 22  | 22     | 22     | 22     | 24     | 24     | 24     | 24     |
| 标准 / Standard                           | IEC 61076-2-101   |        |        |        |        |        |        |        |
| 接线方式 / Termination                      | 焊接和成型 /Welding And Forming  |        |        |        |        |        |        |        |
| 锁紧方式 / Connect locking system           | 螺纹锁紧 / Screw Lock   |        |        |        |        |        |        |        |
| 防护等级 / Degree of protection             | IP65 / IP67   |        |        |        |        |        |        |        |
| 插拔次数 / Mechanical durability            | 500 次   |        |        |        |        |        |        |        |
| 工作温度 / Operation temperature            | -25 °C ~ +85 °C   |        |        |        |        |        |        |        |
| 阻抗 / Resistance                         | 接触电阻 / Contact Resistance: ≤ 10mΩ 绝缘电阻 / Insulation Resistance: ≥ 1000MΩ  |        |        |        |        |        |        |        |
| 材料 (胶芯/端子/壳体/成型) / Material             | 胶芯: PA+GF/TPU 端子: 黄铜镀金/磷铜镀金 壳体: 黄铜合金镀镍/PA+GF 成型: TPU/PVC<br>Housing: PA+GF/TPU Terminal: Brass With Gold Plated / Phosphor Bronze With Gold Plated<br>shell: Copper Alloy With Nickel Plated/PA+GF Forming: TPU/PVC |        |        |        |        |        |        |        |

## M12公弯头成型式线束 屏蔽/非屏蔽 线长L可定制

产品图 / Product photo



尺寸图 / Dimension

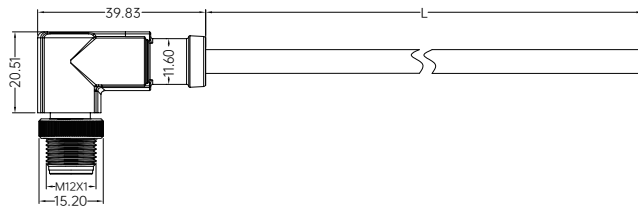

针位分布前视图 / Pin assignment front view

|        | 2 Pin | 3 Pin | 4 Pin | 5 Pin | 6 Pin | 8 Pin | 12 Pin | 17 Pin |
|--------|-------|-------|-------|-------|-------|-------|--------|--------|
| A-code |       |       |       |       |       |       |        |        |
| B-code |       |       |       |       |       |       |        |        |
| D-code |       |       |       |       |       |       |        |        |

订货信息 / Order daea

| 芯数 / Contacts | 编码 / Code | 产品料号("L"表示长度, 单位毫米mm) / Part number ("L" is length millimetre mm) |                   |                   |                   |
|---------------|-----------|---|-------------------|-------------------|-------------------|
|               |           | 1: PVC 无屏蔽  | 2: PUR 无屏蔽        | 3: PVC 带屏蔽        | 4: PUR 带屏蔽        |
| 02 Pin        | A-code    | M12A02-09-011-1-L   | M12A02-09-011-2-L | M12A02-09-011-3-L | M12A02-09-011-4-L |
| 03 Pin        | A-code    | M12A03-09-011-1-L   | M12A03-09-011-2-L | M12A03-09-011-3-L | M12A03-09-011-4-L |
| 04 Pin        | A-code    | M12A04-09-011-1-L   | M12A04-09-011-2-L | M12A04-09-011-3-L | M12A04-09-011-4-L |
| 05 Pin        | A-code    | M12A05-09-011-1-L   | M12A05-09-011-2-L | M12A05-09-011-3-L | M12A05-09-011-4-L |
| 06 Pin        | A-code    | M12A06-09-011-1-L   | M12A06-09-011-2-L | M12A06-09-011-3-L | M12A06-09-011-4-L |
| 08 Pin        | A-code    | M12A08-09-011-1-L   | M12A08-09-011-2-L | M12A08-09-011-3-L | M12A08-09-011-4-L |
| 12 Pin        | A-code    | M12A12-09-011-1-L   | M12A12-09-011-2-L | M12A12-09-011-3-L | M12A12-09-011-4-L |
| 17 Pin        | A-code    | M12A17-09-011-1-L   | M12A17-09-011-2-L | M12A17-09-011-3-L | M12A17-09-011-4-L |
| 02 Pin        | B-code    | M12B02-09-011-1-L   | M12B02-09-011-2-L | M12B02-09-011-3-L | M12B02-09-011-4-L |
| 03 Pin        | B-code    | M12B03-09-011-1-L   | M12B03-09-011-2-L | M12B03-09-011-3-L | M12B03-09-011-4-L |
| 04 Pin        | B-code    | M12B04-09-011-1-L   | M12B04-09-011-2-L | M12B04-09-011-3-L | M12B04-09-011-4-L |
| 05 Pin        | B-code    | M12B05-09-011-1-L   | M12B05-09-011-2-L | M12B05-09-011-3-L | M12B05-09-011-4-L |
| 02 Pin        | D-code    | M12D02-09-011-1-L   | M12D02-09-011-2-L | M12D02-09-011-3-L | M12D02-09-011-4-L |
| 03 Pin        | D-code    | M12D03-09-011-1-L   | M12D03-09-011-2-L | M12D03-09-011-3-L | M12B03-09-011-4-L |
| 04 Pin        | D-code    | M12D04-09-011-1-L   | M12D04-09-011-2-L | M12D04-09-011-3-L | M12B04-09-011-4-L |

技术参数 / Specifications

| 芯数 / Pin                                | 02 Pin  | 03 Pin | 04 Pin | 05 Pin | 06 Pin | 08 Pin | 12 Pin | 17 Pin |
|---|---|--------|--------|--------|--------|--------|--------|--------|
| 编码 / Code                               | A/B/D   | A/B/D  | A/B/D  | A/B    | A      | A      | A      | A      |
| 额定电流 / Rated current                    | 4 A   | 4 A    | 4 A    | 4 A    | 2 A    | 2 A    | 1.5 A  | 1.5 A  |
| 额定电压 / Rated voltage                    | 250 V   | 250 V  | 250 V  | 60 V   | 30 V   | 30 V   | 30 V   | 30 V   |
| 线规 (平方数) / Wire gauge(mm <sup>2</sup> ) | 0.34  | 0.34   | 0.34   | 0.34   | 0.25   | 0.25   | 0.14   | 0.14   |
| 线号 / Wire gauge(AWG)                    | 22  | 22     | 22     | 22     | 24     | 24     | 24     | 24     |
| 标准 / Standard                           | IEC 61076-2-101   |        |        |        |        |        |        |        |
| 接线方式 / Termination                      | 焊接和成型 /Welding And Forming  |        |        |        |        |        |        |        |
| 锁紧方式 / Connect locking system           | 螺纹锁紧 / Screw Lock   |        |        |        |        |        |        |        |
| 防护等级 / Degree of protection             | IP65 / IP67   |        |        |        |        |        |        |        |
| 插拔次数 / Mechanical durability            | 500 次   |        |        |        |        |        |        |        |
| 工作温度 / Operation temperature            | -25 °C ~ +85 °C   |        |        |        |        |        |        |        |
| 阻抗 / Resistance                         | 接触电阻 / Contact Resistance: ≤ 10mΩ 绝缘电阻 / Insulation Resistance: ≥ 1000MΩ  |        |        |        |        |        |        |        |
| 材料 (胶芯/端子/壳体/成型) / Material             | 胶芯: PA+GF/TPU 端子: 黄铜镀金/磷铜镀金 壳体: 黄铜合金镀镍/PA+GF 成型: TPU/PVC<br>Housing: PA+GF/TPU Terminal: Brass With Gold Plated / Phosphor Bronze With Gold Plated<br>shell: Copper Alloy With Nickel Plated/PA+GF Forming: TPU/PVC |        |        |        |        |        |        |        |

联系热线: 400-888-3128

网址: <https://www.dzgu.com>

## M12母弯头成型式线束 屏蔽/非屏蔽 线长L可定制

产品图 / Product photo



尺寸图 / Dimension

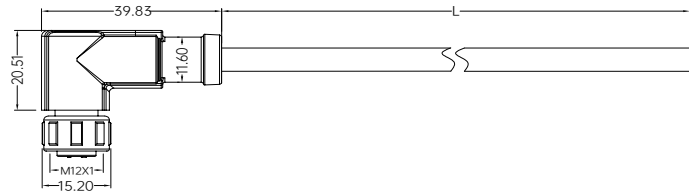

针位分布前视图 / Pin assignment front view

|        | 2 Pin | 3 Pin | 4 Pin | 5 Pin | 6 Pin | 8 Pin | 12 Pin | 17 Pin |
|--------|-------|-------|-------|-------|-------|-------|--------|--------|
| A-code |       |       |       |       |       |       |        |        |
| B-code |       |       |       |       |       |       |        |        |
| D-code |       |       |       |       |       |       |        |        |

订货信息 / Order daea

| 芯数 / Contacts | 编码 / Code | 产品料号("L"表示长度, 单位毫米mm) / Part number ("L" is length millimetre mm) |                   |                   |                   |
|---------------|-----------|---|-------------------|-------------------|-------------------|
|               |           | 1: PVC 无屏蔽  | 2: PUR 无屏蔽        | 3: PVC 带屏蔽        | 4: PUR 带屏蔽        |
| 02 Pin        | A-code    | M12A02-10-011-1-L   | M12A02-10-011-2-L | M12A02-10-011-3-L | M12A02-10-011-4-L |
| 03 Pin        | A-code    | M12A03-10-011-1-L   | M12A03-10-011-2-L | M12A03-10-011-3-L | M12A03-10-011-4-L |
| 04 Pin        | A-code    | M12A04-10-011-1-L   | M12A04-10-011-2-L | M12A04-10-011-3-L | M12A04-10-011-4-L |
| 05 Pin        | A-code    | M12A05-10-011-1-L   | M12A05-10-011-2-L | M12A05-10-011-3-L | M12A05-10-011-4-L |
| 06 Pin        | A-code    | M12A06-10-011-1-L   | M12A06-10-011-2-L | M12A06-10-011-3-L | M12A06-10-011-4-L |
| 08 Pin        | A-code    | M12A08-10-011-1-L   | M12A08-10-011-2-L | M12A08-01-011-3-L | M12A08-10-011-4-L |
| 12 Pin        | A-code    | M12A12-10-011-1-L   | M12A12-10-011-2-L | M12A12-10-011-3-L | M12A12-10-011-4-L |
| 17 Pin        | A-code    | M12A17-10-011-1-L   | M12A17-10-011-2-L | M12A17-10-011-3-L | M12A17-10-011-4-L |
| 02 Pin        | B-code    | M12B02-10-011-1-L   | M12B02-10-011-2-L | M12B02-10-011-3-L | M12B02-10-011-4-L |
| 03 Pin        | B-code    | M12B03-10-011-1-L   | M12B03-10-011-2-L | M12B03-10-011-3-L | M12B03-10-011-4-L |
| 04 Pin        | B-code    | M12B04-10-011-1-L   | M12B04-10-011-2-L | M12B04-10-011-3-L | M12B04-10-011-4-L |
| 05 Pin        | B-code    | M12B05-10-011-1-L   | M12B05-10-011-2-L | M12B05-10-011-3-L | M12B05-10-011-4-L |
| 02 Pin        | D-code    | M12D02-10-011-1-L   | M12D02-10-011-2-L | M12D02-10-011-3-L | M12D02-10-011-4-L |
| 03 Pin        | D-code    | M12D03-10-011-1-L   | M12D03-10-011-2-L | M12D03-10-011-3-L | M12B03-10-011-4-L |
| 04 Pin        | D-code    | M12D04-10-011-1-L   | M12D04-10-011-2-L | M12D04-10-011-3-L | M12B04-10-011-4-L |

技术参数 / Specifications

| 芯数 / Pin                                | 02 Pin  | 03 Pin | 04 Pin | 05 Pin | 06 Pin | 08 Pin | 12 Pin | 17 Pin |
|---|---|--------|--------|--------|--------|--------|--------|--------|
| 编码 / Code                               | A/B/D   | A/B/D  | A/B/D  | A/B    | A      | A      | A      | A      |
| 额定电流 / Rated current                    | 4 A   | 4 A    | 4 A    | 4 A    | 2 A    | 2 A    | 1.5 A  | 1.5 A  |
| 额定电压 / Rated voltage                    | 250 V   | 250 V  | 250 V  | 60 V   | 30 V   | 30 V   | 30 V   | 30 V   |
| 线规 (平方数) / Wire gauge(mm <sup>2</sup> ) | 0.34  | 0.34   | 0.34   | 0.34   | 0.25   | 0.25   | 0.14   | 0.14   |
| 线号 / Wire gauge(AWG)                    | 22  | 22     | 22     | 22     | 24     | 24     | 24     | 24     |
| 标准 / Standard                           | IEC 61076-2-101   |        |        |        |        |        |        |        |
| 接线方式 / Termination                      | 焊接和成型 /Welding And Forming  |        |        |        |        |        |        |        |
| 锁紧方式 / Connect locking system           | 螺纹锁紧 / Screw Lock   |        |        |        |        |        |        |        |
| 防护等级 / Degree of protection             | IP65 / IP67   |        |        |        |        |        |        |        |
| 插拔次数 / Mechanical durability            | 500 次   |        |        |        |        |        |        |        |
| 工作温度 / Operation temperature            | -25 °C ~ +85 °C   |        |        |        |        |        |        |        |
| 阻抗 / Resistance                         | 接触电阻 / Contact Resistance: ≤ 10mΩ 绝缘电阻 / Insulation Resistance: ≥ 1000MΩ  |        |        |        |        |        |        |        |
| 材料 (胶芯/端子/壳体/成型) / Material             | 胶芯: PA+GF/TPU 端子: 黄铜镀金/磷铜镀金 壳体: 黄铜合金镀镍/PA+GF 成型: TPU/PVC<br>Housing: PA+GF/TPU Terminal: Brass With Gold Plated / Phosphor Bronze With Gold Plated<br>shell: Copper Alloy With Nickel Plated/PA+GF Forming: TPU/PVC |        |        |        |        |        |        |        |

联系热线: 400-888-3128

网址: <https://www.dzgu.com>

M5  
M8  
M9  
M12  
M16  
M23  
7/8

## M16公直头金属款组装式插头 压接型

产品图 / Product photo



尺寸图 / Dimension

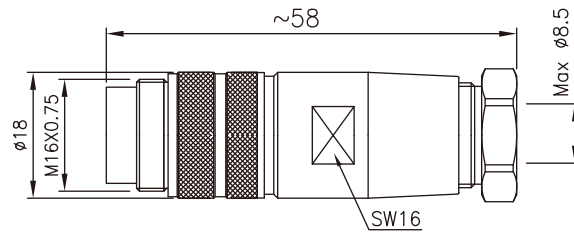

针位分布前视图 / Pin assignment front view

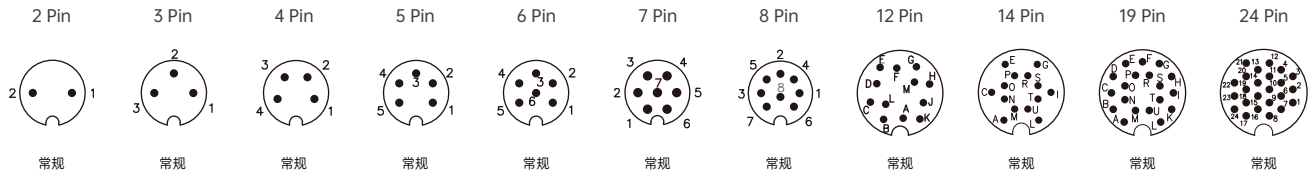

订货信息 / Order daec

| 芯数 / Number of cores | Coding | 料号 / Part number | 芯数 / Number of cores | Coding | 料号 / Part number |
|----------------------|--------|------------------|----------------------|--------|------------------|
| 02 Pin               | 常规     | M16002-01-013    | 08 Pin               | 常规     | M16008-01-013    |
| 03 Pin               | 常规     | M16003-01-013    | 12 Pin               | 常规     | M16012-01-013    |
| 04 Pin               | 常规     | M16004-01-013    | 14 Pin               | 常规     | M16014-01-013    |
| 05 Pin               | 常规     | M16005-01-013    | 19 Pin               | 常规     | M16019-01-013    |
| 06 Pin               | 常规     | M16006-01-013    | 24 Pin               | 常规     | M16024-01-013    |
| 07 Pin               | 常规     | M16007-01-013    |                      |        |                  |

技术参数 / Specifications

| 芯数 / Pin   | 02 Pin  | 03 Pin              | 04 Pin              | 05 Pin              | 06 Pin              | 07 Pin              | 08 Pin              | 12 Pin              | 14 Pin              | 19 Pin              | 24 Pin              |
|--|---|---------------------|---------------------|---------------------|---------------------|---------------------|---------------------|---------------------|---------------------|---------------------|---------------------|
| 额定电流 / Rated Current                                 | 7 A   | 7 A                 | 6 A                 | 6 A                 | 5 A                 | 5 A                 | 5 A                 | 3 A                 | 3 A                 | 3 A                 | 1 A                 |
| 额定电压(A/C交流) / Rated voltage                          | 250V  | 250V                | 250V                | 250V                | 250V                | 125V                | 125V                | 60V                 | 60V                 | 60V                 | 60V                 |
| 额定电压(D/C直流) / Rated voltage                          | 250V  | 250V                | 250V                | 250V                | 250V                | 125V                | 125V                | 60V                 | 60V                 | 60V                 | 60V                 |
| 线规 (mm <sup>2</sup> ) / Wire gauge(mm <sup>2</sup> ) | 0.75mm <sup>2</sup>   | 0.75mm <sup>2</sup> | 0.75mm <sup>2</sup> | 0.75mm <sup>2</sup> | 0.75mm <sup>2</sup> | 0.75mm <sup>2</sup> | 0.75mm <sup>2</sup> | 0.25mm <sup>2</sup> | 0.25mm <sup>2</sup> | 0.25mm <sup>2</sup> | 0.14mm <sup>2</sup> |
| 线号 (AWG) / Wire gauge(AWG)                           | 20AWG   | 20AWG               | 20AWG               | 20AWG               | 20AWG               | 20AWG               | 20AWG               | 24AWG               | 24AWG               | 24AWG               | 26AWG               |
| 壳体材料 / Outer shell material                          | 黄铜合金镀镍/PA+GF / Copper Alloy With Nickel Plated/PA+GF                  |                     |                     |                     |                     |                     |                     |                     |                     |                     |                     |
| 胶芯材料 / Housing material                              | PA+GF/TPU   |                     |                     |                     |                     |                     |                     |                     |                     |                     |                     |
| 成型材料 / Molding material                              | TPU/PVC   |                     |                     |                     |                     |                     |                     |                     |                     |                     |                     |
| 端子材料 / Pin Material                                  | 黄铜镀金/磷铜镀金 / Brass With Gold Plated / Phosphor Bronze With Gold Plated |                     |                     |                     |                     |                     |                     |                     |                     |                     |                     |
| 适用温度 / Applicable temperature                        | -20 °C ~ +80 °C   |                     |                     |                     |                     |                     |                     |                     |                     |                     |                     |
| 绝缘电阻 / Insulation resistance                         | ≥ 100MΩ   |                     |                     |                     |                     |                     |                     |                     |                     |                     |                     |
| 接触电阻 / Contact resistance                            | ≤ 5mΩ   |                     |                     |                     |                     |                     |                     |                     |                     |                     |                     |
| 防护等级 / Degree of protection                          | IP67 / IP68   |                     |                     |                     |                     |                     |                     |                     |                     |                     |                     |
| 插拔次数 / Mechanical durability                         | ≥ 500次  |                     |                     |                     |                     |                     |                     |                     |                     |                     |                     |
| 线材 / Wire rod  | PVC/PUR   |                     |                     |                     |                     |                     |                     |                     |                     |                     |                     |

## M16母直头金属款组装式插头 压接型

产品图 / Product photo



尺寸图 / Dimension

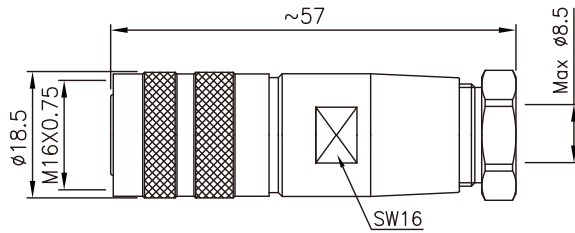

针位分布前视图 / Pin assignment front view

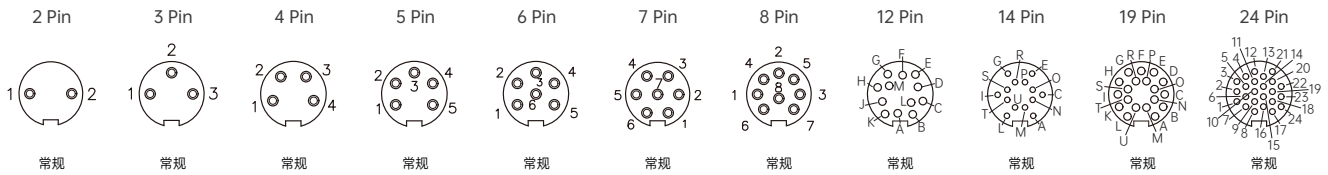

订货信息 / Order daec

| 芯数 / Number of cores | Coding | 料号 / Part number | 芯数 / Number of cores | Coding | 料号 / Part number |
|----------------------|--------|------------------|----------------------|--------|------------------|
| 02 Pin               | 常规     | M16002-02-013    | 08 Pin               | 常规     | M16008-02-013    |
| 03 Pin               | 常规     | M16003-02-013    | 12 Pin               | 常规     | M16012-02-013    |
| 04 Pin               | 常规     | M16004-02-013    | 14 Pin               | 常规     | M16014-02-013    |
| 05 Pin               | 常规     | M16005-02-013    | 19 Pin               | 常规     | M16019-02-013    |
| 06 Pin               | 常规     | M16006-02-013    | 24 Pin               | 常规     | M16024-02-013    |
| 07 Pin               | 常规     | M16007-02-013    |                      |        |                  |

技术参数 / Specifications

| 芯数 / Pin   | 02 Pin  | 03 Pin              | 04 Pin              | 05 Pin              | 06 Pin              | 07 Pin              | 08 Pin              | 12 Pin              | 14 Pin              | 19 Pin              | 24 Pin              |
|--|---|---------------------|---------------------|---------------------|---------------------|---------------------|---------------------|---------------------|---------------------|---------------------|---------------------|
| 额定电流 / Rated current                                 | 7 A   | 7 A                 | 6 A                 | 6 A                 | 5 A                 | 5 A                 | 5 A                 | 3 A                 | 3 A                 | 3 A                 | 1 A                 |
| 额定电压(A/C交流) / Rated voltage                          | 250V  | 250V                | 250V                | 250V                | 250V                | 125V                | 125V                | 60V                 | 60V                 | 60V                 | 60V                 |
| 额定电压(D/C直流) / Rated voltage                          | 250V  | 250V                | 250V                | 250V                | 250V                | 125V                | 125V                | 60V                 | 60V                 | 60V                 | 60V                 |
| 线规 (mm <sup>2</sup> ) / Wire gauge(mm <sup>2</sup> ) | 0.75mm <sup>2</sup>   | 0.75mm <sup>2</sup> | 0.75mm <sup>2</sup> | 0.75mm <sup>2</sup> | 0.75mm <sup>2</sup> | 0.75mm <sup>2</sup> | 0.75mm <sup>2</sup> | 0.25mm <sup>2</sup> | 0.25mm <sup>2</sup> | 0.25mm <sup>2</sup> | 0.14mm <sup>2</sup> |
| 线号 (AWG) / Wire gauge(AWG)                           | 20AWG   | 20AWG               | 20AWG               | 20AWG               | 20AWG               | 20AWG               | 20AWG               | 24AWG               | 24AWG               | 24AWG               | 26AWG               |
| 壳体材料 / Outer shell material                          | 黄铜合金镀镍/PA+GF / Copper Alloy With Nickel Plated/PA+GF                  |                     |                     |                     |                     |                     |                     |                     |                     |                     |                     |
| 胶芯材料 / Housing material                              | PA+GF/TPU   |                     |                     |                     |                     |                     |                     |                     |                     |                     |                     |
| 成型材料 / Molding material                              | TPU/PVC   |                     |                     |                     |                     |                     |                     |                     |                     |                     |                     |
| 端子材料 / Pin material                                  | 黄铜镀金/磷铜镀金 / Brass With Gold Plated / Phosphor Bronze With Gold Plated |                     |                     |                     |                     |                     |                     |                     |                     |                     |                     |
| 适用温度 / Applicable temperature                        | -20 °C ~ +80 °C   |                     |                     |                     |                     |                     |                     |                     |                     |                     |                     |
| 绝缘电阻 / Insulation resistance                         | ≥ 100MΩ   |                     |                     |                     |                     |                     |                     |                     |                     |                     |                     |
| 接触电阻 / Contact resistance                            | ≤ 5mΩ   |                     |                     |                     |                     |                     |                     |                     |                     |                     |                     |
| 防护等级 / Degree of protection                          | IP67 / IP68   |                     |                     |                     |                     |                     |                     |                     |                     |                     |                     |
| 插拔次数 / Mechanical durability                         | ≥ 500次  |                     |                     |                     |                     |                     |                     |                     |                     |                     |                     |
| 线材 / Wire rod  | PVC/PUR   |                     |                     |                     |                     |                     |                     |                     |                     |                     |                     |

## M16公直头金属款组装式插头 焊接型

产品图 / Product photo



尺寸图 / Dimension

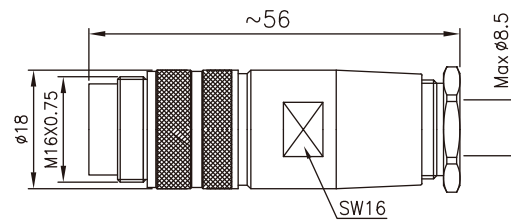

针位分布前视图 / Pin assignment front view

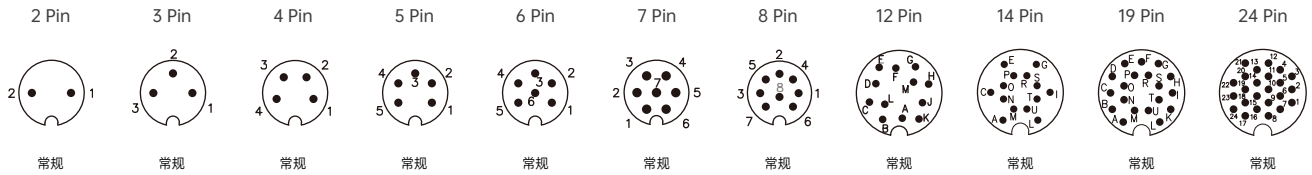

订货信息 / Order daec

| 芯数 / Number of cores | Coding | 料号 / Part number | 芯数 / Number of cores | Coding | 料号 / Part number |
|----------------------|--------|------------------|----------------------|--------|------------------|
| 02 Pin               | 常规     | M16002-01-012    | 08 Pin               | 常规     | M16008-01-012    |
| 03 Pin               | 常规     | M16003-01-012    | 12 Pin               | 常规     | M16012-01-012    |
| 04 Pin               | 常规     | M16004-01-012    | 14 Pin               | 常规     | M16014-01-012    |
| 05 Pin               | 常规     | M16005-01-012    | 19 Pin               | 常规     | M16019-01-012    |
| 06 Pin               | 常规     | M16006-01-012    | 24 Pin               | 常规     | M16024-01-012    |
| 07 Pin               | 常规     | M16007-01-012    |                      |        |                  |

技术参数 / Specifications

| 芯数 / Pin   | 02 Pin  | 03 Pin              | 04 Pin              | 05 Pin              | 06 Pin              | 07 Pin              | 08 Pin              | 12 Pin              | 14 Pin              | 19 Pin              | 24 Pin              |
|--|---|---------------------|---------------------|---------------------|---------------------|---------------------|---------------------|---------------------|---------------------|---------------------|---------------------|
| 额定电流 / Rated current                                 | 7 A   | 7 A                 | 6 A                 | 6 A                 | 5 A                 | 5 A                 | 5 A                 | 3 A                 | 3 A                 | 3 A                 | 1 A                 |
| 额定电压(A/C交流) / Rated voltage                          | 250V  | 250V                | 250V                | 250V                | 250V                | 125V                | 125V                | 60V                 | 60V                 | 60V                 | 60V                 |
| 额定电压(D/C直流) / Rated voltage                          | 250V  | 250V                | 250V                | 250V                | 250V                | 125V                | 125V                | 60V                 | 60V                 | 60V                 | 60V                 |
| 线规 (mm <sup>2</sup> ) / Wire gauge(mm <sup>2</sup> ) | 0.75mm <sup>2</sup>   | 0.75mm <sup>2</sup> | 0.75mm <sup>2</sup> | 0.75mm <sup>2</sup> | 0.75mm <sup>2</sup> | 0.75mm <sup>2</sup> | 0.75mm <sup>2</sup> | 0.25mm <sup>2</sup> | 0.25mm <sup>2</sup> | 0.25mm <sup>2</sup> | 0.14mm <sup>2</sup> |
| 线号 (AWG) / Wire gauge(AWG)                           | 20AWG   | 20AWG               | 20AWG               | 20AWG               | 20AWG               | 20AWG               | 20AWG               | 24AWG               | 24AWG               | 24AWG               | 26AWG               |
| 壳体材料 / Outer shell material                          | 黄铜合金镀镍/PA+GF / Copper Alloy With Nickel Plated/PA+GF                  |                     |                     |                     |                     |                     |                     |                     |                     |                     |                     |
| 胶芯材料 / Housing material                              | PA+GF/TPU   |                     |                     |                     |                     |                     |                     |                     |                     |                     |                     |
| 成型材料 / Molding material                              | TPU/PVC   |                     |                     |                     |                     |                     |                     |                     |                     |                     |                     |
| 端子材料 / Pin material                                  | 黄铜镀金/磷铜镀金 / Brass With Gold Plated / Phosphor Bronze With Gold Plated |                     |                     |                     |                     |                     |                     |                     |                     |                     |                     |
| 适用温度 / Applicable temperature                        | -20 °C ~ +80 °C   |                     |                     |                     |                     |                     |                     |                     |                     |                     |                     |
| 绝缘电阻 / Insulation resistance                         | ≥ 100MΩ   |                     |                     |                     |                     |                     |                     |                     |                     |                     |                     |
| 接触电阻 / Contact resistance                            | ≤ 5mΩ   |                     |                     |                     |                     |                     |                     |                     |                     |                     |                     |
| 防护等级 / Degree of protection                          | IP67 / IP68   |                     |                     |                     |                     |                     |                     |                     |                     |                     |                     |
| 插拔次数 / Mechanical durability                         | ≥ 500次  |                     |                     |                     |                     |                     |                     |                     |                     |                     |                     |
| 线材 / Wire rod  | PVC/PUR   |                     |                     |                     |                     |                     |                     |                     |                     |                     |                     |



## M16母直头金属款组装式插头 焊接型

产品图 / Product photo



尺寸图 / Dimension

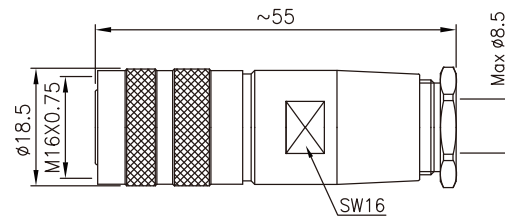

针位分布前视图 / Pin assignment front view

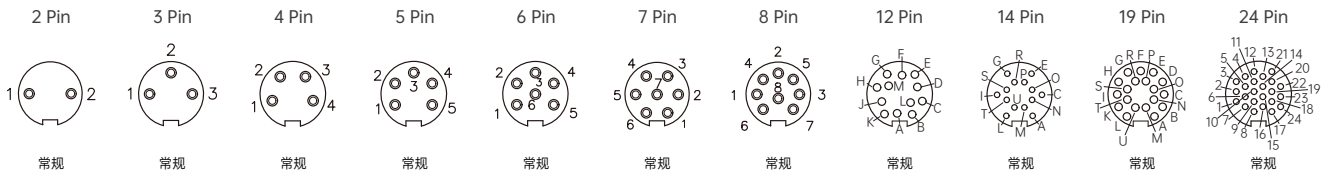

订货信息 / Order daec

| 芯数 / Number of cores | Coding | 料号 / Part number | 芯数 / Number of cores | Coding | 料号 / Part number |
|----------------------|--------|------------------|----------------------|--------|------------------|
| 02 Pin               | 常规     | M16002-02-012    | 08 Pin               | 常规     | M16008-02-012    |
| 03 Pin               | 常规     | M16003-02-012    | 12 Pin               | 常规     | M16012-02-012    |
| 04 Pin               | 常规     | M16004-02-012    | 14 Pin               | 常规     | M16014-02-012    |
| 05 Pin               | 常规     | M16005-02-012    | 19 Pin               | 常规     | M16019-02-012    |
| 06 Pin               | 常规     | M16006-02-012    | 24 Pin               | 常规     | M16024-02-012    |
| 07 Pin               | 常规     | M16007-02-012    |                      |        |                  |

技术参数 / Specifications

| 芯数 / Pin   | 02 Pin  | 03 Pin              | 04 Pin              | 05 Pin              | 06 Pin              | 07 Pin              | 08 Pin              | 12 Pin              | 14 Pin              | 19 Pin              | 24 Pin              |
|--|---|---------------------|---------------------|---------------------|---------------------|---------------------|---------------------|---------------------|---------------------|---------------------|---------------------|
| 额定电流 / Rated current                                 | 7 A   | 7 A                 | 6 A                 | 6 A                 | 5 A                 | 5 A                 | 5 A                 | 3 A                 | 3 A                 | 3 A                 | 1 A                 |
| 额定电压(A/C交流) / Rated voltage                          | 250V  | 250V                | 250V                | 250V                | 250V                | 125V                | 125V                | 60V                 | 60V                 | 60V                 | 60V                 |
| 额定电压(D/C直流) / Rated voltage                          | 250V  | 250V                | 250V                | 250V                | 250V                | 125V                | 125V                | 60V                 | 60V                 | 60V                 | 60V                 |
| 线规 (mm <sup>2</sup> ) / Wire gauge(mm <sup>2</sup> ) | 0.75mm <sup>2</sup>   | 0.75mm <sup>2</sup> | 0.75mm <sup>2</sup> | 0.75mm <sup>2</sup> | 0.75mm <sup>2</sup> | 0.75mm <sup>2</sup> | 0.75mm <sup>2</sup> | 0.25mm <sup>2</sup> | 0.25mm <sup>2</sup> | 0.25mm <sup>2</sup> | 0.14mm <sup>2</sup> |
| 线号 (AWG) / Wire gauge(AWG)                           | 20AWG   | 20AWG               | 20AWG               | 20AWG               | 20AWG               | 20AWG               | 20AWG               | 24AWG               | 24AWG               | 24AWG               | 26AWG               |
| 壳体材料 / Outer shell material                          | 黄铜合金电镀/PA+GF / Copper Alloy With Nickel Plated/PA+GF                  |                     |                     |                     |                     |                     |                     |                     |                     |                     |                     |
| 胶芯材料 / Housing material                              | PA+GF/TPU   |                     |                     |                     |                     |                     |                     |                     |                     |                     |                     |
| 成型材料 / Molding material                              | TPU/PVC   |                     |                     |                     |                     |                     |                     |                     |                     |                     |                     |
| 端子材料 / Pin material                                  | 黄铜镀金/磷铜镀金 / Brass With Gold Plated / Phosphor Bronze With Gold Plated |                     |                     |                     |                     |                     |                     |                     |                     |                     |                     |
| 适用温度 / Applicable temperature                        | -20 °C ~ +80 °C   |                     |                     |                     |                     |                     |                     |                     |                     |                     |                     |
| 绝缘电阻 / Insulation resistance                         | ≥ 100MΩ   |                     |                     |                     |                     |                     |                     |                     |                     |                     |                     |
| 接触电阻 / Contact resistance                            | ≤ 5mΩ   |                     |                     |                     |                     |                     |                     |                     |                     |                     |                     |
| 防护等级 / Degree of protection                          | IP67 / IP68   |                     |                     |                     |                     |                     |                     |                     |                     |                     |                     |
| 插拔次数 / Mechanical durability                         | ≥ 500次  |                     |                     |                     |                     |                     |                     |                     |                     |                     |                     |
| 线材 / Wire rod  | PVC/PUR   |                     |                     |                     |                     |                     |                     |                     |                     |                     |                     |

## M16前锁面板式公头插座 焊线型

产品图 / Product photo



尺寸图 / Dimension

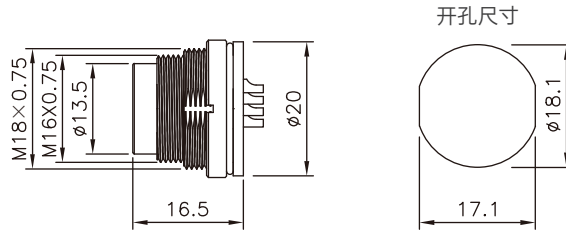

针位分布前视图 / Pin assignment front view

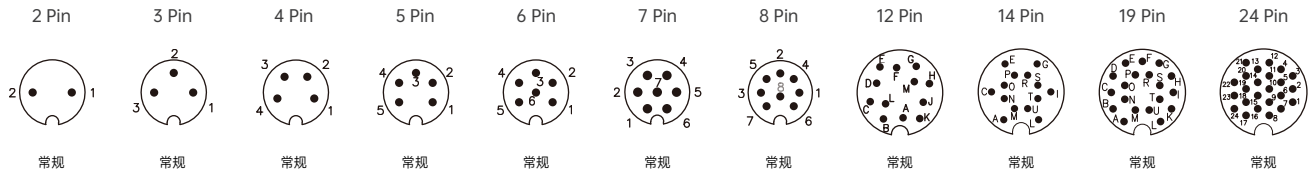

订货信息 / Order daec

| 芯数 / Number of cores | Coding | 料号 / Part number | 芯数 / Number of cores | Coding | 料号 / Part number |
|----------------------|--------|------------------|----------------------|--------|------------------|
| 02 Pin               | 常规     | M16002-03-003    | 08 Pin               | 常规     | M16008-03-003    |
| 03 Pin               | 常规     | M16003-03-003    | 12 Pin               | 常规     | M16012-03-003    |
| 04 Pin               | 常规     | M16004-03-003    | 14 Pin               | 常规     | M16014-03-003    |
| 05 Pin               | 常规     | M16005-03-003    | 19 Pin               | 常规     | M16019-03-003    |
| 06 Pin               | 常规     | M16006-03-003    | 24 Pin               | 常规     | M16024-03-003    |
| 07 Pin               | 常规     | M16007-03-003    |                      |        |                  |

技术参数 / Specifications

| 芯数 / Pin   | 02 Pin  | 03 Pin              | 04 Pin              | 05 Pin              | 06 Pin              | 07 Pin              | 08 Pin              | 12 Pin              | 14 Pin              | 19 Pin              | 24 Pin              |
|--|---|---------------------|---------------------|---------------------|---------------------|---------------------|---------------------|---------------------|---------------------|---------------------|---------------------|
| 额定电流 / Rated current                                 | 7 A   | 7 A                 | 6 A                 | 6 A                 | 5 A                 | 5 A                 | 5 A                 | 3 A                 | 3 A                 | 3 A                 | 1 A                 |
| 额定电压(A/C交流) / Rated voltage                          | 250V  | 250V                | 250V                | 250V                | 250V                | 125V                | 125V                | 60V                 | 60V                 | 60V                 | 60V                 |
| 额定电压(D/C直流) / Rated voltage                          | 250V  | 250V                | 250V                | 250V                | 250V                | 125V                | 125V                | 60V                 | 60V                 | 60V                 | 60V                 |
| 线规 (mm <sup>2</sup> ) / Wire gauge(mm <sup>2</sup> ) | 0.75mm <sup>2</sup>   | 0.75mm <sup>2</sup> | 0.75mm <sup>2</sup> | 0.75mm <sup>2</sup> | 0.75mm <sup>2</sup> | 0.75mm <sup>2</sup> | 0.75mm <sup>2</sup> | 0.25mm <sup>2</sup> | 0.25mm <sup>2</sup> | 0.25mm <sup>2</sup> | 0.14mm <sup>2</sup> |
| 线号 (AWG) / Wire gauge(AWG)                           | 20AWG   | 20AWG               | 20AWG               | 20AWG               | 20AWG               | 20AWG               | 20AWG               | 24AWG               | 24AWG               | 24AWG               | 26AWG               |
| 壳体材料 / Outer shell material                          | 黄铜合金镀镍/PA+GF / Copper Alloy With Nickel Plated/PA+GF                  |                     |                     |                     |                     |                     |                     |                     |                     |                     |                     |
| 胶芯材料 / Housing material                              | PA+GF/TPU   |                     |                     |                     |                     |                     |                     |                     |                     |                     |                     |
| 成型材料 / Molding material                              | TPU/PVC   |                     |                     |                     |                     |                     |                     |                     |                     |                     |                     |
| 端子材料 / Pin material                                  | 黄铜镀金/磷铜镀金 / Brass With Gold Plated / Phosphor Bronze With Gold Plated |                     |                     |                     |                     |                     |                     |                     |                     |                     |                     |
| 适用温度 / Applicable temperature                        | -20 °C ~ +80 °C   |                     |                     |                     |                     |                     |                     |                     |                     |                     |                     |
| 绝缘电阻 / Insulation resistance                         | ≥ 100MΩ   |                     |                     |                     |                     |                     |                     |                     |                     |                     |                     |
| 接触电阻 / Contact resistance                            | ≤ 5mΩ   |                     |                     |                     |                     |                     |                     |                     |                     |                     |                     |
| 防护等级 / Degree of protection                          | IP67 / IP68   |                     |                     |                     |                     |                     |                     |                     |                     |                     |                     |
| 插拔次数 / Mechanical durability                         | ≥ 500次  |                     |                     |                     |                     |                     |                     |                     |                     |                     |                     |
| 线材 / Wire rod  | PVC/PUR   |                     |                     |                     |                     |                     |                     |                     |                     |                     |                     |

## M16前锁面板式公头插座 焊板型

产品图 / Product photo



尺寸图 / Dimension

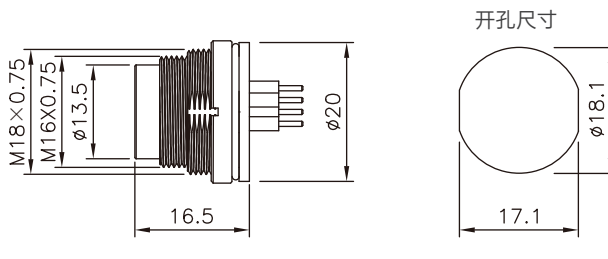

针位分布前视图 / Pin assignment front view

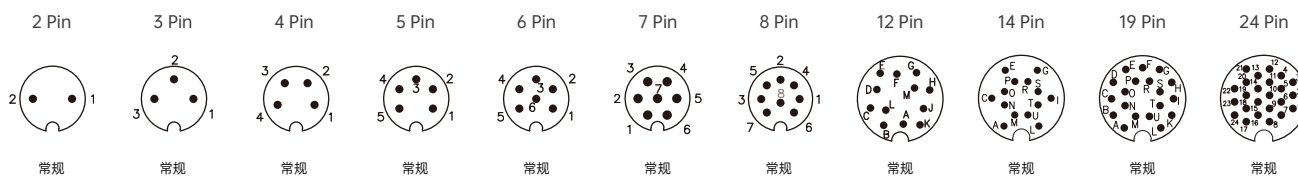

订货信息 / Order daec

| 芯数 / Number of cores | Coding | 料号 / Part number | 芯数 / Number of cores | Coding | 料号 / Part number |
|----------------------|--------|------------------|----------------------|--------|------------------|
| 02 Pin               | 常规     | M16002-03-004    | 08 Pin               | 常规     | M16008-03-004    |
| 03 Pin               | 常规     | M16003-03-004    | 12 Pin               | 常规     | M16012-03-004    |
| 04 Pin               | 常规     | M16004-03-004    | 14 Pin               | 常规     | M16014-03-004    |
| 05 Pin               | 常规     | M16005-03-004    | 19 Pin               | 常规     | M16019-03-004    |
| 06 Pin               | 常规     | M16006-03-004    | 24 Pin               | 常规     | M16024-03-004    |
| 07 Pin               | 常规     | M16007-03-004    |                      |        |                  |

技术参数 / Specifications

| 芯数 / Pin   | 02 Pin  | 03 Pin              | 04 Pin              | 05 Pin              | 06 Pin              | 07 Pin              | 08 Pin              | 12 Pin              | 14 Pin              | 19 Pin              | 24 Pin              |
|--|---|---------------------|---------------------|---------------------|---------------------|---------------------|---------------------|---------------------|---------------------|---------------------|---------------------|
| 额定电流 / Rated current                                 | 7 A   | 7 A                 | 6 A                 | 6 A                 | 5 A                 | 5 A                 | 5 A                 | 3 A                 | 3 A                 | 3 A                 | 1 A                 |
| 额定电压(A/C交流) / Rated voltage                          | 250V  | 250V                | 250V                | 250V                | 250V                | 125V                | 125V                | 60V                 | 60V                 | 60V                 | 60V                 |
| 额定电压(D/C直流) / Rated voltage                          | 250V  | 250V                | 250V                | 250V                | 250V                | 125V                | 125V                | 60V                 | 60V                 | 60V                 | 60V                 |
| 线规 (mm <sup>2</sup> ) / Wire gauge(mm <sup>2</sup> ) | 0.75mm <sup>2</sup>   | 0.75mm <sup>2</sup> | 0.75mm <sup>2</sup> | 0.75mm <sup>2</sup> | 0.75mm <sup>2</sup> | 0.75mm <sup>2</sup> | 0.75mm <sup>2</sup> | 0.25mm <sup>2</sup> | 0.25mm <sup>2</sup> | 0.25mm <sup>2</sup> | 0.14mm <sup>2</sup> |
| 线号 (AWG) / Wire gauge(AWG)                           | 20AWG   | 20AWG               | 20AWG               | 20AWG               | 20AWG               | 20AWG               | 20AWG               | 24AWG               | 24AWG               | 24AWG               | 26AWG               |
| 壳体材料 / Outer shell material                          | 黄铜合金电镀/PA+GF / Copper Alloy With Nickel Plated/PA+GF                  |                     |                     |                     |                     |                     |                     |                     |                     |                     |                     |
| 胶芯材料 / Housing material                              | PA+GF/TPU   |                     |                     |                     |                     |                     |                     |                     |                     |                     |                     |
| 成型材料 / Molding material                              | TPU/PVC   |                     |                     |                     |                     |                     |                     |                     |                     |                     |                     |
| 端子材料 / Pin material                                  | 黄铜镀金/磷铜镀金 / Brass With Gold Plated / Phosphor Bronze With Gold Plated |                     |                     |                     |                     |                     |                     |                     |                     |                     |                     |
| 适用温度 / Applicable temperature                        | -20 °C ~ +80 °C   |                     |                     |                     |                     |                     |                     |                     |                     |                     |                     |
| 绝缘电阻 / Insulation resistance                         | ≥ 100MΩ   |                     |                     |                     |                     |                     |                     |                     |                     |                     |                     |
| 接触电阻 / Contact resistance                            | ≤ 5mΩ   |                     |                     |                     |                     |                     |                     |                     |                     |                     |                     |
| 防护等级 / Degree of protection                          | IP67 / IP68   |                     |                     |                     |                     |                     |                     |                     |                     |                     |                     |
| 插拔次数 / Mechanical durability                         | ≥ 500次  |                     |                     |                     |                     |                     |                     |                     |                     |                     |                     |
| 线材 / Wire rod  | PVC/PUR   |                     |                     |                     |                     |                     |                     |                     |                     |                     |                     |

## M16前锁面板式母头插座 焊线型

产品图 / Product photo



尺寸图 / Dimension

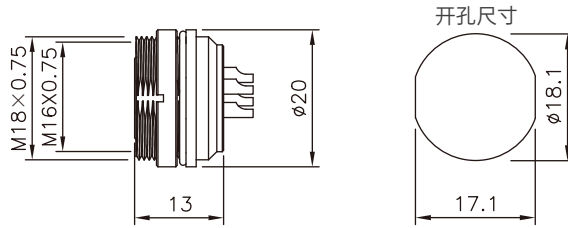

针位分布前视图 / Pin assignment front view

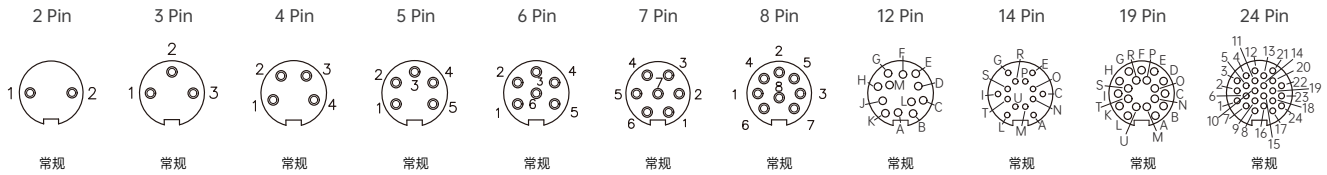

订货信息 / Order daec

| 芯数 / Number of cores | Coding | 料号 / Part number | 芯数 / Number of cores | Coding | 料号 / Part number |
|----------------------|--------|------------------|----------------------|--------|------------------|
| 02 Pin               | 常规     | M16002-04-003    | 08 Pin               | 常规     | M16008-04-003    |
| 03 Pin               | 常规     | M16003-04-003    | 12 Pin               | 常规     | M16012-04-003    |
| 04 Pin               | 常规     | M16004-04-003    | 14 Pin               | 常规     | M16014-04-003    |
| 05 Pin               | 常规     | M16005-04-003    | 19 Pin               | 常规     | M16019-04-003    |
| 06 Pin               | 常规     | M16006-04-003    | 24 Pin               | 常规     | M16024-04-003    |
| 07 Pin               | 常规     | M16007-04-003    |                      |        |                  |

技术参数 / Specifications

| 芯数 / Pin   | 02 Pin  | 03 Pin              | 04 Pin              | 05 Pin              | 06 Pin              | 07 Pin              | 08 Pin              | 12 Pin              | 14 Pin              | 19 Pin              | 24 Pin              |
|--|---|---------------------|---------------------|---------------------|---------------------|---------------------|---------------------|---------------------|---------------------|---------------------|---------------------|
| 额定电流 / Rated current                                 | 7 A   | 7 A                 | 6 A                 | 6 A                 | 5 A                 | 5 A                 | 5 A                 | 3 A                 | 3 A                 | 3 A                 | 1 A                 |
| 额定电压(A/C交流) / Rated voltage                          | 250V  | 250V                | 250V                | 250V                | 250V                | 125V                | 125V                | 60V                 | 60V                 | 60V                 | 60V                 |
| 额定电压(D/C直流) / Rated voltage                          | 250V  | 250V                | 250V                | 250V                | 250V                | 125V                | 125V                | 60V                 | 60V                 | 60V                 | 60V                 |
| 线规 (mm <sup>2</sup> ) / Wire gauge(mm <sup>2</sup> ) | 0.75mm <sup>2</sup>   | 0.75mm <sup>2</sup> | 0.75mm <sup>2</sup> | 0.75mm <sup>2</sup> | 0.75mm <sup>2</sup> | 0.75mm <sup>2</sup> | 0.75mm <sup>2</sup> | 0.25mm <sup>2</sup> | 0.25mm <sup>2</sup> | 0.25mm <sup>2</sup> | 0.14mm <sup>2</sup> |
| 线号 (AWG) / Wire gauge(AWG)                           | 20AWG   | 20AWG               | 20AWG               | 20AWG               | 20AWG               | 20AWG               | 20AWG               | 24AWG               | 24AWG               | 24AWG               | 26AWG               |
| 壳体材料 / Outer shell material                          | 黄铜合金镀镍/PA+GF / Copper Alloy With Nickel Plated/PA+GF                  |                     |                     |                     |                     |                     |                     |                     |                     |                     |                     |
| 胶芯材料 / Housing material                              | PA+GF/TPU   |                     |                     |                     |                     |                     |                     |                     |                     |                     |                     |
| 成型材料 / Molding material                              | TPU/PVC   |                     |                     |                     |                     |                     |                     |                     |                     |                     |                     |
| 端子材料 / Pin material                                  | 黄铜镀金/磷铜镀金 / Brass With Gold Plated / Phosphor Bronze With Gold Plated |                     |                     |                     |                     |                     |                     |                     |                     |                     |                     |
| 适用温度 / Applicable temperature                        | -20 °C ~ +80 °C   |                     |                     |                     |                     |                     |                     |                     |                     |                     |                     |
| 绝缘电阻 / Insulation resistance                         | ≥ 100MΩ   |                     |                     |                     |                     |                     |                     |                     |                     |                     |                     |
| 接触电阻 / Contact resistance                            | ≤ 5mΩ   |                     |                     |                     |                     |                     |                     |                     |                     |                     |                     |
| 防护等级 / Degree of protection                          | IP67 / IP68   |                     |                     |                     |                     |                     |                     |                     |                     |                     |                     |
| 插拔次数 / Mechanical durability                         | ≥ 500次  |                     |                     |                     |                     |                     |                     |                     |                     |                     |                     |

## M16前锁面板式母头插座 焊板型

产品图 / Product photo



尺寸图 / Dimension

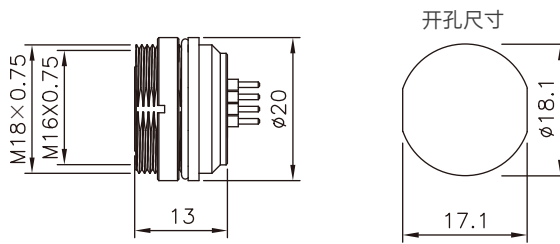

针位分布前视图 / Pin assignment front view

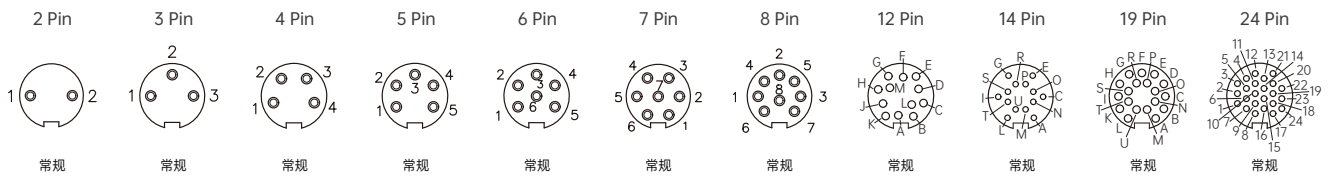

订货信息 / Order daea

| 芯数 / Number of cores | Coding | 料号 / Part number | 芯数 / Number of cores | Coding | 料号 / Part number |
|----------------------|--------|------------------|----------------------|--------|------------------|
| 02 Pin               | 常规     | M16002-04-004    | 08 Pin               | 常规     | M16008-04-004    |
| 03 Pin               | 常规     | M16003-04-004    | 12 Pin               | 常规     | M16012-04-004    |
| 04 Pin               | 常规     | M16004-04-004    | 14 Pin               | 常规     | M16014-04-004    |
| 05 Pin               | 常规     | M16005-04-004    | 19 Pin               | 常规     | M16019-04-004    |
| 06 Pin               | 常规     | M16006-04-004    | 24 Pin               | 常规     | M16024-04-004    |
| 07 Pin               | 常规     | M16007-04-004    |                      |        |                  |

技术参数 / Specifications

| 芯数 / Pin   | 02 Pin  | 03 Pin              | 04 Pin              | 05 Pin              | 06 Pin              | 07 Pin              | 08 Pin              | 12 Pin              | 14 Pin              | 19 Pin              | 24 Pin              |
|--|---|---------------------|---------------------|---------------------|---------------------|---------------------|---------------------|---------------------|---------------------|---------------------|---------------------|
| 额定电流 / Rated current                                 | 7 A   | 7 A                 | 6 A                 | 6 A                 | 5 A                 | 5 A                 | 5 A                 | 3 A                 | 3 A                 | 3 A                 | 1 A                 |
| 额定电压(A/C交流) / Rated voltage                          | 250V  | 250V                | 250V                | 250V                | 250V                | 125V                | 125V                | 60V                 | 60V                 | 60V                 | 60V                 |
| 额定电压(D/C直流) / Rated voltage                          | 250V  | 250V                | 250V                | 250V                | 250V                | 125V                | 125V                | 60V                 | 60V                 | 60V                 | 60V                 |
| 线规 (mm <sup>2</sup> ) / Wire gauge(mm <sup>2</sup> ) | 0.75mm <sup>2</sup>   | 0.75mm <sup>2</sup> | 0.75mm <sup>2</sup> | 0.75mm <sup>2</sup> | 0.75mm <sup>2</sup> | 0.75mm <sup>2</sup> | 0.75mm <sup>2</sup> | 0.25mm <sup>2</sup> | 0.25mm <sup>2</sup> | 0.25mm <sup>2</sup> | 0.14mm <sup>2</sup> |
| 线号 (AWG) / Wire gauge(AWG)                           | 20AWG   | 20AWG               | 20AWG               | 20AWG               | 20AWG               | 20AWG               | 20AWG               | 24AWG               | 24AWG               | 24AWG               | 26AWG               |
| 壳体材料 / Outer shell material                          | 黄铜合金镀镍/PA+GF / Copper Alloy With Nickel Plated/PA+GF                  |                     |                     |                     |                     |                     |                     |                     |                     |                     |                     |
| 胶芯材料 / Housing material                              | PA+GF/TPU   |                     |                     |                     |                     |                     |                     |                     |                     |                     |                     |
| 成型材料 / Molding material                              | TPU/PVC   |                     |                     |                     |                     |                     |                     |                     |                     |                     |                     |
| 端子材料 / Pin material                                  | 黄铜镀金/磷铜镀金 / Brass With Gold Plated / Phosphor Bronze With Gold Plated |                     |                     |                     |                     |                     |                     |                     |                     |                     |                     |
| 适用温度 / Applicable temperature                        | -20 °C ~ +80 °C   |                     |                     |                     |                     |                     |                     |                     |                     |                     |                     |
| 绝缘电阻 / Insulation resistance                         | ≥ 100MΩ   |                     |                     |                     |                     |                     |                     |                     |                     |                     |                     |
| 接触电阻 / Contact resistance                            | ≤ 5mΩ   |                     |                     |                     |                     |                     |                     |                     |                     |                     |                     |
| 防护等级 / Degree of protection                          | IP67 / IP68   |                     |                     |                     |                     |                     |                     |                     |                     |                     |                     |
| 插拔次数 / Mechanical durability                         | ≥ 500次  |                     |                     |                     |                     |                     |                     |                     |                     |                     |                     |

## M16后锁面板式公头插座 焊线型

产品图 / Product photo



尺寸图 / Dimension

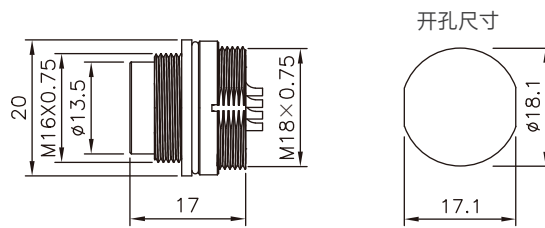

针位分布前视图 / Pin assignment front view

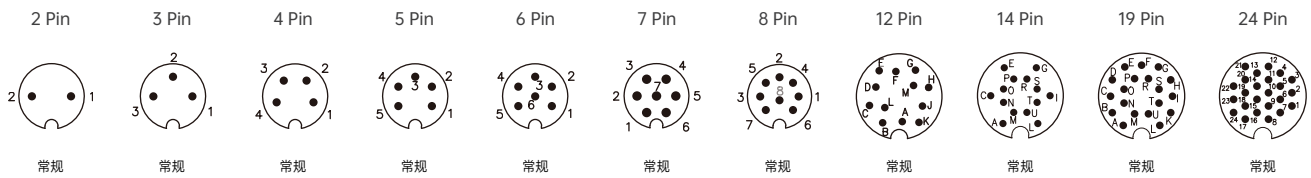

订货信息 / Order daec

| 芯数 / Number of cores | Coding | 料号 / Part number | 芯数 / Number of cores | Coding | 料号 / Part number |
|----------------------|--------|------------------|----------------------|--------|------------------|
| 02 Pin               | 常规     | M16002-03-001    | 08 Pin               | 常规     | M16008-03-001    |
| 03 Pin               | 常规     | M16003-03-001    | 12 Pin               | 常规     | M16012-03-001    |
| 04 Pin               | 常规     | M16004-03-001    | 14 Pin               | 常规     | M16014-03-001    |
| 05 Pin               | 常规     | M16005-03-001    | 19 Pin               | 常规     | M16019-03-001    |
| 06 Pin               | 常规     | M16006-03-001    | 24 Pin               | 常规     | M16024-03-001    |
| 07 Pin               | 常规     | M16007-03-001    |                      |        |                  |

技术参数 / Specifications

| 芯数 / Pin   | 02 Pin  | 03 Pin              | 04 Pin              | 05 Pin              | 06 Pin              | 07 Pin              | 08 Pin              | 12 Pin              | 14 Pin              | 19 Pin              | 24 Pin              |
|--|---|---------------------|---------------------|---------------------|---------------------|---------------------|---------------------|---------------------|---------------------|---------------------|---------------------|
| 额定电流 / Rated current                                 | 7 A   | 7 A                 | 6 A                 | 6 A                 | 5 A                 | 5 A                 | 5 A                 | 3 A                 | 3 A                 | 3 A                 | 1 A                 |
| 额定电压(A/C交流) / Rated voltage                          | 250V  | 250V                | 250V                | 250V                | 250V                | 125V                | 125V                | 60V                 | 60V                 | 60V                 | 60V                 |
| 额定电压(D/C直流) / Rated voltage                          | 250V  | 250V                | 250V                | 250V                | 250V                | 125V                | 125V                | 60V                 | 60V                 | 60V                 | 60V                 |
| 线规 (mm <sup>2</sup> ) / Wire gauge(mm <sup>2</sup> ) | 0.75mm <sup>2</sup>   | 0.75mm <sup>2</sup> | 0.75mm <sup>2</sup> | 0.75mm <sup>2</sup> | 0.75mm <sup>2</sup> | 0.75mm <sup>2</sup> | 0.75mm <sup>2</sup> | 0.25mm <sup>2</sup> | 0.25mm <sup>2</sup> | 0.25mm <sup>2</sup> | 0.14mm <sup>2</sup> |
| 线号 (AWG) / Wire gauge(AWG)                           | 20AWG   | 20AWG               | 20AWG               | 20AWG               | 20AWG               | 20AWG               | 20AWG               | 24AWG               | 24AWG               | 24AWG               | 26AWG               |
| 壳体材料 / Outer shell material                          | 黄铜合金镀镍/PA+GF / Copper Alloy With Nickel Plated/PA+GF                  |                     |                     |                     |                     |                     |                     |                     |                     |                     |                     |
| 胶芯材料 / Housing material                              | PA+GF/TPU   |                     |                     |                     |                     |                     |                     |                     |                     |                     |                     |
| 成型材料 / Molding material                              | TPU/PVC   |                     |                     |                     |                     |                     |                     |                     |                     |                     |                     |
| 端子材料 / Pin material                                  | 黄铜镀金/磷铜镀金 / Brass With Gold Plated / Phosphor Bronze With Gold Plated |                     |                     |                     |                     |                     |                     |                     |                     |                     |                     |
| 适用温度 / Applicable temperature                        | -20 °C ~ +80 °C   |                     |                     |                     |                     |                     |                     |                     |                     |                     |                     |
| 绝缘电阻 / Insulation resistance                         | ≥ 100MΩ   |                     |                     |                     |                     |                     |                     |                     |                     |                     |                     |
| 接触电阻 / Contact resistance                            | ≤ 5mΩ   |                     |                     |                     |                     |                     |                     |                     |                     |                     |                     |
| 防护等级 / Degree of protection                          | IP67 / IP68   |                     |                     |                     |                     |                     |                     |                     |                     |                     |                     |
| 插拔次数 / Mechanical durability                         | ≥ 500次  |                     |                     |                     |                     |                     |                     |                     |                     |                     |                     |
| 线材 / Wire rod  | PVC/PUR   |                     |                     |                     |                     |                     |                     |                     |                     |                     |                     |

## M16后锁面板式公头插座 焊板型

产品图 / Product photo



尺寸图 / Dimension

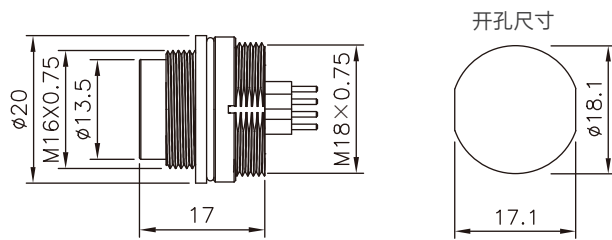

针位分布前视图 / Pin assignment front view

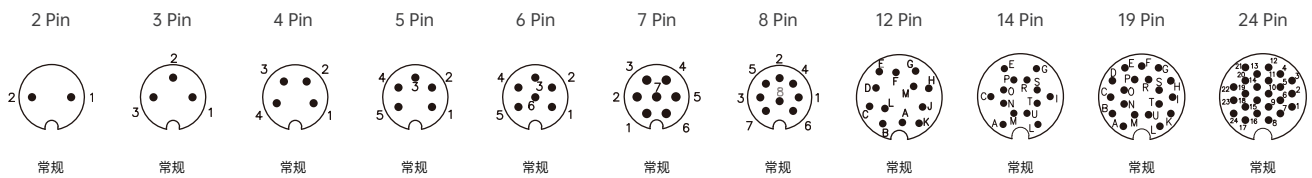

订货信息 / Order daec

| 芯数 / Number of cores | Coding | 料号 / Part number | 芯数 / Number of cores | Coding | 料号 / Part number |
|----------------------|--------|------------------|----------------------|--------|------------------|
| 02 Pin               | 常规     | M16002-03-002    | 08 Pin               | 常规     | M16008-03-002    |
| 03 Pin               | 常规     | M16003-03-002    | 12 Pin               | 常规     | M16012-03-002    |
| 04 Pin               | 常规     | M16004-03-002    | 14 Pin               | 常规     | M16014-03-002    |
| 05 Pin               | 常规     | M16005-03-002    | 19 Pin               | 常规     | M16019-03-002    |
| 06 Pin               | 常规     | M16006-03-002    | 24 Pin               | 常规     | M16024-03-002    |
| 07 Pin               | 常规     | M16007-03-002    |                      |        |                  |

技术参数 / Specifications

| 芯数 / Pin   | 02 Pin  | 03 Pin              | 04 Pin              | 05 Pin              | 06 Pin              | 07 Pin              | 08 Pin              | 12 Pin              | 14 Pin              | 19 Pin              | 24 Pin              |
|--|---|---------------------|---------------------|---------------------|---------------------|---------------------|---------------------|---------------------|---------------------|---------------------|---------------------|
| 额定电流 / Rated current                                 | 7 A   | 7 A                 | 6 A                 | 6 A                 | 5 A                 | 5 A                 | 5 A                 | 3 A                 | 3 A                 | 3 A                 | 1 A                 |
| 额定电压(A/C交流) / Rated voltage                          | 250V  | 250V                | 250V                | 250V                | 250V                | 125V                | 125V                | 60V                 | 60V                 | 60V                 | 60V                 |
| 额定电压(D/C直流) / Rated voltage                          | 250V  | 250V                | 250V                | 250V                | 250V                | 125V                | 125V                | 60V                 | 60V                 | 60V                 | 60V                 |
| 线规 (mm <sup>2</sup> ) / Wire gauge(mm <sup>2</sup> ) | 0.75mm <sup>2</sup>   | 0.75mm <sup>2</sup> | 0.75mm <sup>2</sup> | 0.75mm <sup>2</sup> | 0.75mm <sup>2</sup> | 0.75mm <sup>2</sup> | 0.75mm <sup>2</sup> | 0.25mm <sup>2</sup> | 0.25mm <sup>2</sup> | 0.25mm <sup>2</sup> | 0.14mm <sup>2</sup> |
| 线号 (AWG) / Wire gauge(AWG)                           | 20AWG   | 20AWG               | 20AWG               | 20AWG               | 20AWG               | 20AWG               | 20AWG               | 24AWG               | 24AWG               | 24AWG               | 26AWG               |
| 壳体材料 / Outer shell material                          | 黄铜合金镀镍/PA+GF / Copper Alloy With Nickel Plated/PA+GF                  |                     |                     |                     |                     |                     |                     |                     |                     |                     |                     |
| 胶芯材料 / Housing material                              | PA+GF/TPU   |                     |                     |                     |                     |                     |                     |                     |                     |                     |                     |
| 成型材料 / Molding material                              | TPU/PVC   |                     |                     |                     |                     |                     |                     |                     |                     |                     |                     |
| 端子材料 / Pin material                                  | 黄铜镀金/磷铜镀金 / Brass With Gold Plated / Phosphor Bronze With Gold Plated |                     |                     |                     |                     |                     |                     |                     |                     |                     |                     |
| 适用温度 / Applicable temperature                        | -20 °C ~ +80 °C   |                     |                     |                     |                     |                     |                     |                     |                     |                     |                     |
| 绝缘电阻 / Insulation resistance                         | ≥ 100MΩ   |                     |                     |                     |                     |                     |                     |                     |                     |                     |                     |
| 接触电阻 / Contact resistance                            | ≤ 5mΩ   |                     |                     |                     |                     |                     |                     |                     |                     |                     |                     |
| 防护等级 / Degree of protection                          | IP67 / IP68   |                     |                     |                     |                     |                     |                     |                     |                     |                     |                     |
| 插拔次数 / Mechanical durability                         | ≥ 500次  |                     |                     |                     |                     |                     |                     |                     |                     |                     |                     |
| 线材 / Wire rod  | PVC/PUR   |                     |                     |                     |                     |                     |                     |                     |                     |                     |                     |

## M16后锁面板式母头插座 焊线型

产品图 / Product photo



尺寸图 / Dimension

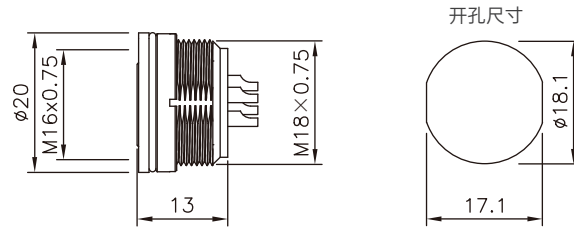

针位分布前视图 / Pin assignment front view

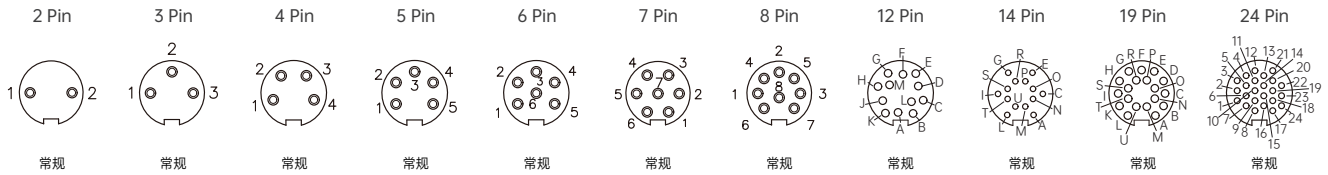

订货信息 / Order daec

| 芯数 / Number of cores | Coding | 料号 / Part number | 芯数 / Number of cores | Coding | 料号 / Part number |
|----------------------|--------|------------------|----------------------|--------|------------------|
| 02 Pin               | 常规     | M16002-04-001    | 08 Pin               | 常规     | M16008-04-001    |
| 03 Pin               | 常规     | M16003-04-001    | 12 Pin               | 常规     | M16012-04-001    |
| 04 Pin               | 常规     | M16004-04-001    | 14 Pin               | 常规     | M16014-04-001    |
| 05 Pin               | 常规     | M16005-04-001    | 19 Pin               | 常规     | M16019-04-001    |
| 06 Pin               | 常规     | M16006-04-001    | 24 Pin               | 常规     | M16024-04-001    |
| 07 Pin               | 常规     | M16007-04-001    |                      |        |                  |

技术参数 / Specifications

| 芯数 / Pin   | 02 Pin  | 03 Pin              | 04 Pin              | 05 Pin              | 06 Pin              | 07 Pin              | 08 Pin              | 12 Pin              | 14 Pin              | 19 Pin              | 24 Pin              |
|--|---|---------------------|---------------------|---------------------|---------------------|---------------------|---------------------|---------------------|---------------------|---------------------|---------------------|
| 额定电流 / Rated current                                 | 7 A   | 7 A                 | 6 A                 | 6 A                 | 5 A                 | 5 A                 | 5 A                 | 3 A                 | 3 A                 | 3 A                 | 1 A                 |
| 额定电压(A/C交流) / Rated voltage                          | 250V  | 250V                | 250V                | 250V                | 250V                | 125V                | 125V                | 60V                 | 60V                 | 60V                 | 60V                 |
| 额定电压(D/C直流) / Rated voltage                          | 250V  | 250V                | 250V                | 250V                | 250V                | 125V                | 125V                | 60V                 | 60V                 | 60V                 | 60V                 |
| 线规 (mm <sup>2</sup> ) / Wire gauge(mm <sup>2</sup> ) | 0.75mm <sup>2</sup>   | 0.75mm <sup>2</sup> | 0.75mm <sup>2</sup> | 0.75mm <sup>2</sup> | 0.75mm <sup>2</sup> | 0.75mm <sup>2</sup> | 0.75mm <sup>2</sup> | 0.25mm <sup>2</sup> | 0.25mm <sup>2</sup> | 0.25mm <sup>2</sup> | 0.14mm <sup>2</sup> |
| 线号 (AWG) / Wire gauge(AWG)                           | 20AWG   | 20AWG               | 20AWG               | 20AWG               | 20AWG               | 20AWG               | 20AWG               | 24AWG               | 24AWG               | 24AWG               | 26AWG               |
| 壳体材料 / Outer shell material                          | 黄铜合金镀镍/PA+GF / Copper Alloy With Nickel Plated/PA+GF                  |                     |                     |                     |                     |                     |                     |                     |                     |                     |                     |
| 胶芯材料 / Housing material                              | PA+GF/TPU   |                     |                     |                     |                     |                     |                     |                     |                     |                     |                     |
| 成型材料 / Molding material                              | TPU/PVC   |                     |                     |                     |                     |                     |                     |                     |                     |                     |                     |
| 端子材料 / Pin material                                  | 黄铜镀金/磷铜镀金 / Brass With Gold Plated / Phosphor Bronze With Gold Plated |                     |                     |                     |                     |                     |                     |                     |                     |                     |                     |
| 适用温度 / Applicable temperature                        | -20 °C ~ +80 °C   |                     |                     |                     |                     |                     |                     |                     |                     |                     |                     |
| 绝缘电阻 / Insulation resistance                         | ≥ 100MΩ   |                     |                     |                     |                     |                     |                     |                     |                     |                     |                     |
| 接触电阻 / Contact resistance                            | ≤ 5mΩ   |                     |                     |                     |                     |                     |                     |                     |                     |                     |                     |
| 防护等级 / Degree of protection                          | IP67 / IP68   |                     |                     |                     |                     |                     |                     |                     |                     |                     |                     |
| 插拔次数 / Mechanical durability                         | ≥ 500次  |                     |                     |                     |                     |                     |                     |                     |                     |                     |                     |
| 线材 / Wire rod  | PVC/PUR   |                     |                     |                     |                     |                     |                     |                     |                     |                     |                     |



## M16后锁面板式母头插座 焊板型

产品图 / Product photo



尺寸图 / Dimension

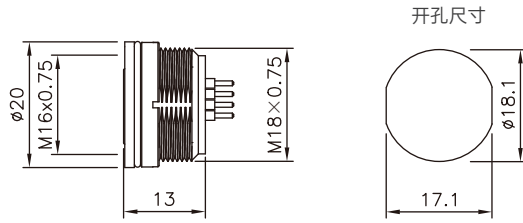

开孔尺寸

针位分布前视图 / Pin assignment front view

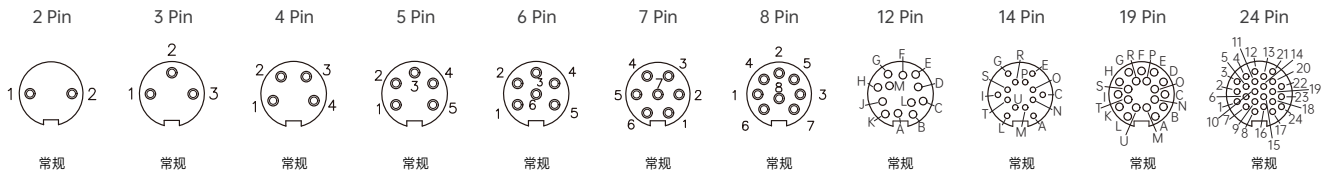

订货信息 / Order daea

| 芯数 / Number of cores | Coding | 料号 / Part number | 芯数 / Number of cores | Coding | 料号 / Part number |
|----------------------|--------|------------------|----------------------|--------|------------------|
| 02 Pin               | 常规     | M16002-04-002    | 08 Pin               | 常规     | M16008-04-002    |
| 03 Pin               | 常规     | M16003-04-002    | 12 Pin               | 常规     | M16012-04-002    |
| 04 Pin               | 常规     | M16004-04-002    | 14 Pin               | 常规     | M16014-04-002    |
| 05 Pin               | 常规     | M16005-04-002    | 19 Pin               | 常规     | M16019-04-002    |
| 06 Pin               | 常规     | M16006-04-002    | 24 Pin               | 常规     | M16024-04-002    |
| 07 Pin               | 常规     | M16007-04-002    |                      |        |                  |

技术参数 / Specifications

| 芯数 / Pin   | 02 Pin  | 03 Pin              | 04 Pin              | 05 Pin              | 06 Pin              | 07 Pin              | 08 Pin              | 12 Pin              | 14 Pin              | 19 Pin              | 24 Pin              |
|--|---|---------------------|---------------------|---------------------|---------------------|---------------------|---------------------|---------------------|---------------------|---------------------|---------------------|
| 额定电流 / Rated current                                 | 7 A   | 7 A                 | 6 A                 | 6 A                 | 5 A                 | 5 A                 | 5 A                 | 3 A                 | 3 A                 | 3 A                 | 1 A                 |
| 额定电压(A/C交流) / Rated voltage                          | 250V  | 250V                | 250V                | 250V                | 250V                | 125V                | 125V                | 60V                 | 60V                 | 60V                 | 60V                 |
| 额定电压(D/C直流) / Rated voltage                          | 250V  | 250V                | 250V                | 250V                | 250V                | 125V                | 125V                | 60V                 | 60V                 | 60V                 | 60V                 |
| 线规 (mm <sup>2</sup> ) / Wire gauge(mm <sup>2</sup> ) | 0.75mm <sup>2</sup>   | 0.75mm <sup>2</sup> | 0.75mm <sup>2</sup> | 0.75mm <sup>2</sup> | 0.75mm <sup>2</sup> | 0.75mm <sup>2</sup> | 0.75mm <sup>2</sup> | 0.25mm <sup>2</sup> | 0.25mm <sup>2</sup> | 0.25mm <sup>2</sup> | 0.14mm <sup>2</sup> |
| 线号 (AWG) / Wire gauge(AWG)                           | 20AWG   | 20AWG               | 20AWG               | 20AWG               | 20AWG               | 20AWG               | 20AWG               | 24AWG               | 24AWG               | 24AWG               | 26AWG               |
| 壳体材料 / Outer shell material                          | 黄铜合金镀镍/PA+GF / Copper Alloy With Nickel Plated/PA+GF                  |                     |                     |                     |                     |                     |                     |                     |                     |                     |                     |
| 胶芯材料 / Housing material                              | PA+GF/TPU   |                     |                     |                     |                     |                     |                     |                     |                     |                     |                     |
| 成型材料 / Molding material                              | TPU/PVC   |                     |                     |                     |                     |                     |                     |                     |                     |                     |                     |
| 端子材料 / Pin material                                  | 黄铜镀金/磷铜镀金 / Brass With Gold Plated / Phosphor Bronze With Gold Plated |                     |                     |                     |                     |                     |                     |                     |                     |                     |                     |
| 适用温度 / Applicable temperature                        | -20 °C ~ +80 °C   |                     |                     |                     |                     |                     |                     |                     |                     |                     |                     |
| 绝缘电阻 / Insulation resistance                         | ≥ 100MΩ   |                     |                     |                     |                     |                     |                     |                     |                     |                     |                     |
| 接触电阻 / Contact resistance                            | ≤ 5mΩ   |                     |                     |                     |                     |                     |                     |                     |                     |                     |                     |
| 防护等级 / Degree of protection                          | IP67 / IP68   |                     |                     |                     |                     |                     |                     |                     |                     |                     |                     |
| 插拔次数 / Mechanical durability                         | ≥ 500次  |                     |                     |                     |                     |                     |                     |                     |                     |                     |                     |

## M16面板式方形法兰公头插座 焊线型 安装孔20x20

产品图 / Product photo



尺寸图 / Dimension

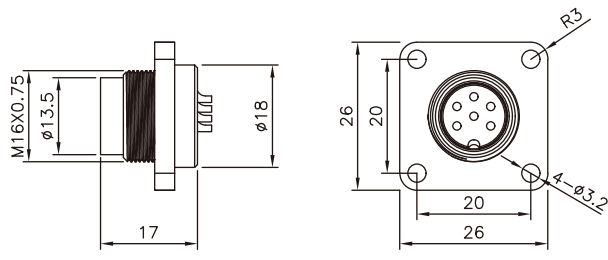

针位分布前视图 / Pin assignment front view

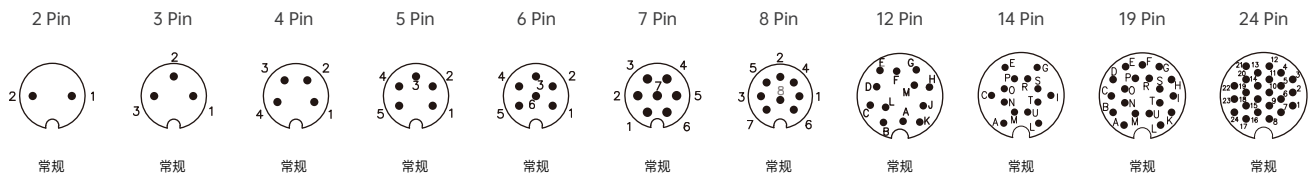

订货信息 / Order daec

| 芯数 / Number of cores | Coding | 料号 / Part number | 芯数 / Number of cores | Coding | 料号 / Part number |
|----------------------|--------|------------------|----------------------|--------|------------------|
| 02 Pin               | 常规     | M16002-03-005    | 08 Pin               | 常规     | M16008-03-005    |
| 03 Pin               | 常规     | M16003-03-005    | 12 Pin               | 常规     | M16012-03-005    |
| 04 Pin               | 常规     | M16004-03-005    | 14 Pin               | 常规     | M16014-03-005    |
| 05 Pin               | 常规     | M16005-03-005    | 19 Pin               | 常规     | M16019-03-005    |
| 06 Pin               | 常规     | M16006-03-005    | 24 Pin               | 常规     | M16024-03-005    |
| 07 Pin               | 常规     | M16007-03-005    |                      |        |                  |

技术参数 / Specifications

| 芯数 / Pin   | 02 Pin  | 03 Pin              | 04 Pin              | 05 Pin              | 06 Pin              | 07 Pin              | 08 Pin              | 12 Pin              | 14 Pin              | 19 Pin              | 24 Pin              |
|--|---|---------------------|---------------------|---------------------|---------------------|---------------------|---------------------|---------------------|---------------------|---------------------|---------------------|
| 额定电流 / Rated current                                 | 7 A   | 7 A                 | 6 A                 | 6 A                 | 5 A                 | 5 A                 | 5 A                 | 3 A                 | 3 A                 | 3 A                 | 1 A                 |
| 额定电压(A/C交流) / Rated voltage                          | 250V  | 250V                | 250V                | 250V                | 250V                | 125V                | 125V                | 60V                 | 60V                 | 60V                 | 60V                 |
| 额定电压(D/C直流) / Rated voltage                          | 250V  | 250V                | 250V                | 250V                | 250V                | 125V                | 125V                | 60V                 | 60V                 | 60V                 | 60V                 |
| 线规 (mm <sup>2</sup> ) / Wire gauge(mm <sup>2</sup> ) | 0.75mm <sup>2</sup>   | 0.75mm <sup>2</sup> | 0.75mm <sup>2</sup> | 0.75mm <sup>2</sup> | 0.75mm <sup>2</sup> | 0.75mm <sup>2</sup> | 0.75mm <sup>2</sup> | 0.25mm <sup>2</sup> | 0.25mm <sup>2</sup> | 0.25mm <sup>2</sup> | 0.14mm <sup>2</sup> |
| 线号 (AWG) / Wire gauge(AWG)                           | 20AWG   | 20AWG               | 20AWG               | 20AWG               | 20AWG               | 20AWG               | 20AWG               | 24AWG               | 24AWG               | 24AWG               | 26AWG               |
| 壳体材料 / Outer shell material                          | 黄铜合金镀镍/PA+GF / Copper Alloy With Nickel Plated/PA+GF                  |                     |                     |                     |                     |                     |                     |                     |                     |                     |                     |
| 胶芯材料 / Housing material                              | PA+GF/TPU   |                     |                     |                     |                     |                     |                     |                     |                     |                     |                     |
| 成型材料 / Molding material                              | TPU/PVC   |                     |                     |                     |                     |                     |                     |                     |                     |                     |                     |
| 端子材料 / Pin material                                  | 黄铜镀金/磷铜镀金 / Brass With Gold Plated / Phosphor Bronze With Gold Plated |                     |                     |                     |                     |                     |                     |                     |                     |                     |                     |
| 适用温度 / Applicable temperature                        | -20 °C ~ +80 °C   |                     |                     |                     |                     |                     |                     |                     |                     |                     |                     |
| 绝缘电阻 / Insulation resistance                         | ≥ 100MΩ   |                     |                     |                     |                     |                     |                     |                     |                     |                     |                     |
| 接触电阻 / Contact resistance                            | ≤ 5mΩ   |                     |                     |                     |                     |                     |                     |                     |                     |                     |                     |
| 防护等级 / Degree of protection                          | IP67 / IP68   |                     |                     |                     |                     |                     |                     |                     |                     |                     |                     |
| 插拔次数 / Mechanical durability                         | ≥ 500次  |                     |                     |                     |                     |                     |                     |                     |                     |                     |                     |
| 线材 / Wire rod  | PVC/PUR   |                     |                     |                     |                     |                     |                     |                     |                     |                     |                     |

## M16面板式方形法兰母头插座 焊线型 安装孔20x20

产品图 / Product photo



尺寸图 / Dimension

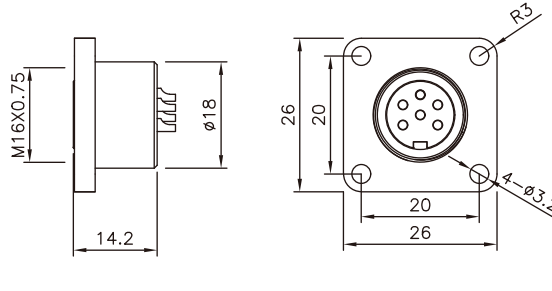

针位分布前视图 / Pin assignment front view

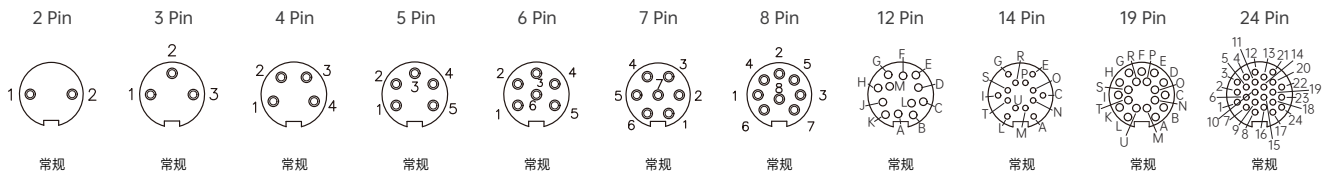

订货信息 / Order daea

| 芯数 / Number of cores | Coding | 料号 / Part number | 芯数 / Number of cores | Coding | 料号 / Part number |
|----------------------|--------|------------------|----------------------|--------|------------------|
| 02 Pin               | 常规     | M16002-04-005    | 08 Pin               | 常规     | M16008-04-005    |
| 03 Pin               | 常规     | M16003-04-005    | 12 Pin               | 常规     | M16012-04-005    |
| 04 Pin               | 常规     | M16004-04-005    | 14 Pin               | 常规     | M16014-04-005    |
| 05 Pin               | 常规     | M16005-04-005    | 19 Pin               | 常规     | M16019-04-005    |
| 06 Pin               | 常规     | M16006-04-005    | 24 Pin               | 常规     | M16024-04-005    |
| 07 Pin               | 常规     | M16007-04-005    |                      |        |                  |

技术参数 / Specifications

| 芯数 / Pin   | 02 Pin  | 03 Pin              | 04 Pin              | 05 Pin              | 06 Pin              | 07 Pin              | 08 Pin              | 12 Pin              | 14 Pin              | 19 Pin              | 24 Pin              |
|--|---|---------------------|---------------------|---------------------|---------------------|---------------------|---------------------|---------------------|---------------------|---------------------|---------------------|
| 额定电流 / Rated current                                 | 7 A   | 7 A                 | 6 A                 | 6 A                 | 5 A                 | 5 A                 | 5 A                 | 3 A                 | 3 A                 | 3 A                 | 1 A                 |
| 额定电压(A/C交流) / Rated voltage                          | 250V  | 250V                | 250V                | 250V                | 250V                | 125V                | 125V                | 60V                 | 60V                 | 60V                 | 60V                 |
| 额定电压(D/C直流) / Rated voltage                          | 250V  | 250V                | 250V                | 250V                | 250V                | 125V                | 125V                | 60V                 | 60V                 | 60V                 | 60V                 |
| 线规 (mm <sup>2</sup> ) / Wire gauge(mm <sup>2</sup> ) | 0.75mm <sup>2</sup>   | 0.75mm <sup>2</sup> | 0.75mm <sup>2</sup> | 0.75mm <sup>2</sup> | 0.75mm <sup>2</sup> | 0.75mm <sup>2</sup> | 0.75mm <sup>2</sup> | 0.25mm <sup>2</sup> | 0.25mm <sup>2</sup> | 0.25mm <sup>2</sup> | 0.14mm <sup>2</sup> |
| 线号 (AWG) / Wire gauge(AWG)                           | 20AWG   | 20AWG               | 20AWG               | 20AWG               | 20AWG               | 20AWG               | 20AWG               | 24AWG               | 24AWG               | 24AWG               | 26AWG               |
| 壳体材料 / Outer shell material                          | 黄铜合金电镀/PA+GF / Copper Alloy With Nickel Plated/PA+GF                  |                     |                     |                     |                     |                     |                     |                     |                     |                     |                     |
| 胶芯材料 / Housing material                              | PA+GF/TPU   |                     |                     |                     |                     |                     |                     |                     |                     |                     |                     |
| 成型材料 / Molding material                              | TPU/PVC   |                     |                     |                     |                     |                     |                     |                     |                     |                     |                     |
| 端子材料 / Pin material                                  | 黄铜镀金/磷铜镀金 / Brass With Gold Plated / Phosphor Bronze With Gold Plated |                     |                     |                     |                     |                     |                     |                     |                     |                     |                     |
| 适用温度 / Applicable temperature                        | -20 °C ~ +80 °C   |                     |                     |                     |                     |                     |                     |                     |                     |                     |                     |
| 绝缘电阻 / Insulation resistance                         | ≥ 100MΩ   |                     |                     |                     |                     |                     |                     |                     |                     |                     |                     |
| 接触电阻 / Contact resistance                            | ≤ 5mΩ   |                     |                     |                     |                     |                     |                     |                     |                     |                     |                     |
| 防护等级 / Degree of protection                          | IP67 / IP68   |                     |                     |                     |                     |                     |                     |                     |                     |                     |                     |
| 插拔次数 / Mechanical durability                         | ≥ 500次  |                     |                     |                     |                     |                     |                     |                     |                     |                     |                     |
| 线材 / Wire rod  | PVC/PUR   |                     |                     |                     |                     |                     |                     |                     |                     |                     |                     |

## M16公直头成型式线束 屏蔽/非屏蔽 线长L可定制

产品图 / Product photo



尺寸图 / Dimension

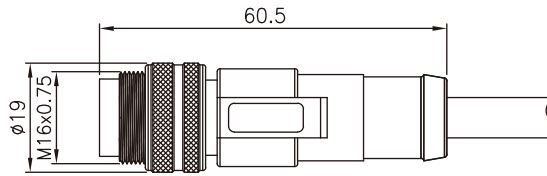

针位分布前视图 / Pin assignment front view

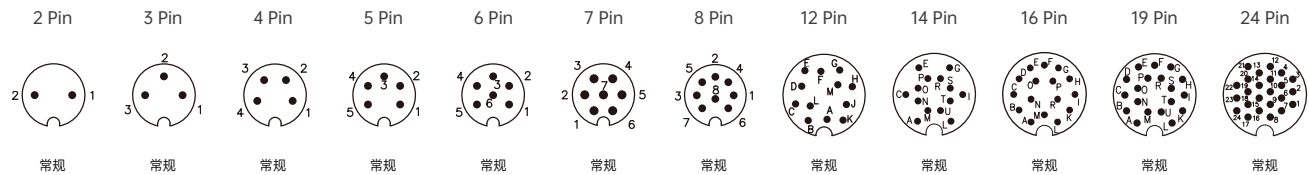

订货信息 / Order daea

| 芯数 / Contacts | 编码 / Code | 产品料号("L"表示长度, 单位毫米mm) / Part number ("L" is length millimetre mm) |                   |                   |                   |
|---------------|-----------|---|-------------------|-------------------|-------------------|
|               |           | 1: PVC 无屏蔽  | 2: PUR 无屏蔽        | 3: PVC 带屏蔽        | 4: PUR 带屏蔽        |
| 02 Pin        | 常规        | M16002-09-010-1-L   | M16002-09-010-2-L | M16002-09-010-3-L | M16002-09-010-4-L |
| 03 Pin        | 常规        | M16003-09-010-1-L   | M16003-09-010-2-L | M16003-09-010-3-L | M16003-09-010-4-L |
| 04 Pin        | 常规        | M16004-09-010-1-L   | M16004-09-010-2-L | M16004-09-010-3-L | M16004-09-010-4-L |
| 05 Pin        | 常规        | M16005-09-010-1-L   | M16005-09-010-2-L | M16005-09-010-3-L | M16005-09-010-4-L |
| 06 Pin        | 常规        | M16006-09-010-1-L   | M16006-09-010-2-L | M16006-09-010-3-L | M16006-09-010-4-L |
| 07 Pin        | 常规        | M16007-09-010-1-L   | M16007-09-010-2-L | M16007-09-010-3-L | M16007-09-010-4-L |
| 08 Pin        | 常规        | M16008-09-010-1-L   | M16008-09-010-2-L | M16008-09-010-3-L | M16008-09-010-4-L |
| 12 Pin        | 常规        | M16012-09-010-1-L   | M16012-09-010-2-L | M16012-09-010-3-L | M16012-09-010-4-L |
| 14 Pin        | 常规        | M16014-09-010-1-L   | M16014-09-010-2-L | M16014-09-010-3-L | M16014-09-010-4-L |
| 16 Pin        | 常规        | M16016-09-010-1-L   | M16016-09-010-2-L | M16016-09-010-3-L | M16016-09-010-4-L |
| 19 Pin        | 常规        | M16019-09-010-1-L   | M16019-09-010-2-L | M16019-09-010-3-L | M16019-09-010-4-L |
| 24 Pin        | 常规        | M16024-09-010-1-L   | M16024-09-010-2-L | M16024-09-010-3-L | M16024-09-010-4-L |

技术参数 / Specifications

| 芯数 / Pin   | 02 Pin  | 03 Pin | 04 Pin | 05 Pin | 06 Pin | 07 Pin | 08 Pin | 12 Pin | 14 Pin | 16 Pin | 19 Pin | 24 Pin |
|--|---|--------|--------|--------|--------|--------|--------|--------|--------|--------|--------|--------|
| 额定电流 / Rated current                                 | 7 A   | 7 A    | 6 A    | 6 A    | 5 A    | 5 A    | 5 A    | 3 A    | 3 A    | 3 A    | 3 A    | 1 A    |
| 额定电压(A/C交流) / Rated voltage                          | 250V  | 250V   | 250V   | 250V   | 250V   | 125V   | 125V   | 60V    | 60V    | 60V    | 60V    | 60V    |
| 额定电压(D/C直流) / Rated voltage                          | 250V  | 250V   | 250V   | 250V   | 250V   | 125V   | 125V   | 60V    | 60V    | 60V    | 60V    | 60V    |
| 线规 (mm <sup>2</sup> ) / Wire gauge(mm <sup>2</sup> ) | 0.75  | 0.75   | 0.75   | 0.75   | 0.75   | 0.75   | 0.75   | 0.25   | 0.25   | 0.25   | 0.25   | 0.14   |
| 线号 (AWG) / Wire gauge(AWG)                           | 20  | 20     | 20     | 20     | 20     | 20     | 20     | 24     | 24     | 24     | 24     | 26     |
| 壳体材料 / Outer shell material                          | 黄铜合金镀镍/PA+GF / Copper Alloy With Nickel Plated/PA+GF                  |        |        |        |        |        |        |        |        |        |        |        |
| 胶芯材料 / Housing material                              | PA+GF/TPU   |        |        |        |        |        |        |        |        |        |        |        |
| 成型材料 / Molding material                              | TPU/PVC   |        |        |        |        |        |        |        |        |        |        |        |
| 端子材料 / Pin material                                  | 黄铜镀金/磷铜镀金 / Brass With Gold Plated / Phosphor Bronze With Gold Plated |        |        |        |        |        |        |        |        |        |        |        |
| 适用温度 / Applicable temperature                        | -20 °C ~ +80 °C   |        |        |        |        |        |        |        |        |        |        |        |
| 绝缘电阻 / Insulation resistance                         | ≥ 100MΩ   |        |        |        |        |        |        |        |        |        |        |        |
| 接触电阻 / Contact resistance                            | ≤ 5mΩ   |        |        |        |        |        |        |        |        |        |        |        |
| 防护等级 / Degree of protection                          | IP67 / IP68   |        |        |        |        |        |        |        |        |        |        |        |
| 插拔次数 / Mechanical durability                         | ≥ 500次  |        |        |        |        |        |        |        |        |        |        |        |
| 线材 / Wire rod  | PVC/PUR   |        |        |        |        |        |        |        |        |        |        |        |

## M16母直头成型式线束 屏蔽/非屏蔽 线长L可定制

产品图 / Product photo



尺寸图 / Dimension

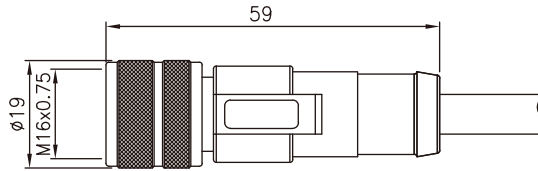

针位分布前视图 / Pin assignment front view

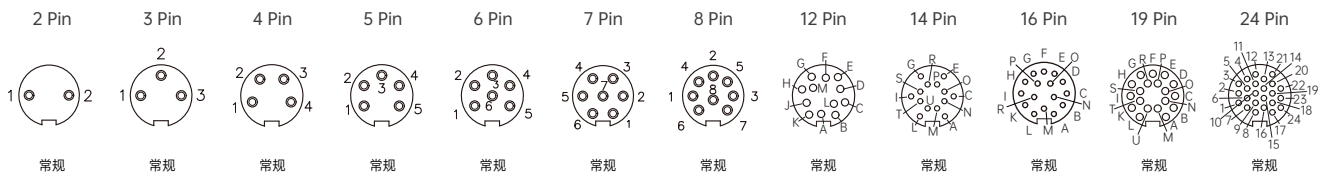

订货信息 / Order daea

| 芯数 / Contacts | 编码 / Code | 产品料号("L"表示长度, 单位毫米mm) / Part number ("L" is length millimetre mm) |                   |                   |                   |
|---------------|-----------|---|-------------------|-------------------|-------------------|
|               |           | 1: PVC 无屏蔽  | 2: PUR 无屏蔽        | 3: PVC 带屏蔽        | 4: PUR 带屏蔽        |
| 02 Pin        | 常规        | M16002-10-010-1-L   | M16002-10-010-2-L | M16002-10-010-3-L | M16002-10-010-4-L |
| 03 Pin        | 常规        | M16003-10-010-1-L   | M16003-10-010-2-L | M16003-10-010-3-L | M16003-10-010-4-L |
| 04 Pin        | 常规        | M16004-10-010-1-L   | M16004-10-010-2-L | M16004-10-010-3-L | M16004-10-010-4-L |
| 05 Pin        | 常规        | M16005-10-010-1-L   | M16005-10-010-2-L | M16005-10-010-3-L | M16005-10-010-4-L |
| 06 Pin        | 常规        | M16006-10-010-1-L   | M16006-10-010-2-L | M16006-10-010-3-L | M16006-10-010-4-L |
| 07 Pin        | 常规        | M16007-10-010-1-L   | M16007-10-010-2-L | M16007-10-010-3-L | M16007-10-010-4-L |
| 08 Pin        | 常规        | M16008-10-010-1-L   | M16008-10-010-2-L | M16008-10-010-3-L | M16008-10-010-4-L |
| 12 Pin        | 常规        | M16012-10-010-1-L   | M16012-10-010-2-L | M16012-10-010-3-L | M16012-10-010-4-L |
| 14 Pin        | 常规        | M16014-10-010-1-L   | M16014-10-010-2-L | M16014-10-010-3-L | M16014-10-010-4-L |
| 16 Pin        | 常规        | M16016-10-010-1-L   | M16016-10-010-2-L | M16016-10-010-3-L | M16016-10-010-4-L |
| 19 Pin        | 常规        | M16019-10-010-1-L   | M16019-10-010-2-L | M16019-10-010-3-L | M16019-10-010-4-L |
| 24 Pin        | 常规        | M16024-10-010-1-L   | M16024-10-010-2-L | M16024-10-010-3-L | M16024-10-010-4-L |

技术参数 / Specifications

| 芯数 / Pin   | 02 Pin  | 03 Pin | 04 Pin | 05 Pin | 06 Pin | 07 Pin | 08 Pin | 12 Pin | 14 Pin | 16 Pin | 19 Pin | 24 Pin |
|--|---|--------|--------|--------|--------|--------|--------|--------|--------|--------|--------|--------|
| 额定电流 / Rated current                                 | 7 A   | 7 A    | 6 A    | 6 A    | 5 A    | 5 A    | 5 A    | 3 A    | 3 A    | 3 A    | 3 A    | 1 A    |
| 额定电压(A/C交流) / Rated voltage                          | 250V  | 250V   | 250V   | 250V   | 250V   | 125V   | 125V   | 60V    | 60V    | 60V    | 60V    | 60V    |
| 额定电压(D/C直流) / Rated voltage                          | 250V  | 250V   | 250V   | 250V   | 250V   | 125V   | 125V   | 60V    | 60V    | 60V    | 60V    | 60V    |
| 线规 (mm <sup>2</sup> ) / Wire gauge(mm <sup>2</sup> ) | 0.75  | 0.75   | 0.75   | 0.75   | 0.75   | 0.75   | 0.75   | 0.25   | 0.25   | 0.25   | 0.25   | 0.14   |
| 线号 (AWG) / Wire gauge(AWG)                           | 20  | 20     | 20     | 20     | 20     | 20     | 20     | 24     | 24     | 24     | 24     | 26     |
| 壳体材料 / Outer shell material                          | 黄铜合金镀镍/PA+GF / Copper Alloy With Nickel Plated/PA+GF                  |        |        |        |        |        |        |        |        |        |        |        |
| 胶芯材料 / Housing material                              | PA+GF/TPU   |        |        |        |        |        |        |        |        |        |        |        |
| 成型材料 / Molding material                              | TPU/PVC   |        |        |        |        |        |        |        |        |        |        |        |
| 端子材料 / Pin material                                  | 黄铜镀金/磷铜镀金 / Brass With Gold Plated / Phosphor Bronze With Gold Plated |        |        |        |        |        |        |        |        |        |        |        |
| 适用温度 / Applicable temperature                        | -20 °C ~ +80 °C   |        |        |        |        |        |        |        |        |        |        |        |
| 绝缘电阻 / Insulation resistance                         | ≥ 100MΩ   |        |        |        |        |        |        |        |        |        |        |        |
| 接触电阻 / Contact resistance                            | ≤ 5mΩ   |        |        |        |        |        |        |        |        |        |        |        |
| 防护等级 / Degree of protection                          | IP67 / IP68   |        |        |        |        |        |        |        |        |        |        |        |
| 插拔次数 / Mechanical durability                         | ≥ 500次  |        |        |        |        |        |        |        |        |        |        |        |
| 线材 / Wire rod  | PVC/PUR   |        |        |        |        |        |        |        |        |        |        |        |

## M16公弯头成型式线束 屏蔽/非屏蔽 线长L可定制

产品图 / Product photo



尺寸图 / Dimension

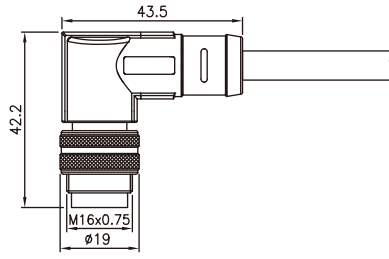

针位分布前视图 / Pin assignment front view

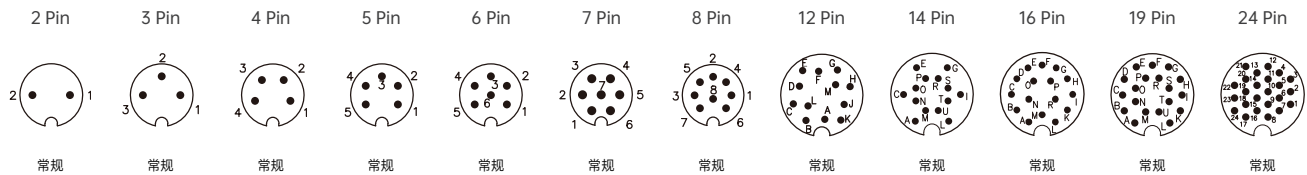

订货信息 / Order daea

| 芯数 / Contacts | 编码 / Code | 产品料号("L"表示长度, 单位毫米mm) / Part number ("L" is length millimetre mm) |                   |                   |                   |
|---------------|-----------|---|-------------------|-------------------|-------------------|
|               |           | 1: PVC 无屏蔽  | 2: PUR 无屏蔽        | 3: PVC 带屏蔽        | 4: PUR 带屏蔽        |
| 02 Pin        | 常规        | M16002-09-011-1-L   | M16002-09-011-2-L | M16002-09-011-3-L | M16002-09-011-4-L |
| 03 Pin        | 常规        | M16003-09-011-1-L   | M16003-09-011-2-L | M16003-09-011-3-L | M16003-09-011-4-L |
| 04 Pin        | 常规        | M16004-09-011-1-L   | M16004-09-011-2-L | M16004-09-011-3-L | M16004-09-011-4-L |
| 05 Pin        | 常规        | M16005-09-011-1-L   | M16005-09-011-2-L | M16005-09-011-3-L | M16005-09-011-4-L |
| 06 Pin        | 常规        | M16006-09-011-1-L   | M16006-09-011-2-L | M16006-09-011-3-L | M16006-09-011-4-L |
| 07 Pin        | 常规        | M16007-09-011-1-L   | M16007-09-011-2-L | M16007-09-011-3-L | M16007-09-011-4-L |
| 08 Pin        | 常规        | M16008-09-011-1-L   | M16008-09-011-2-L | M16008-09-011-3-L | M16008-09-011-4-L |
| 12 Pin        | 常规        | M16012-09-011-1-L   | M16012-09-011-2-L | M16012-09-011-3-L | M16012-09-011-4-L |
| 14 Pin        | 常规        | M16014-09-011-1-L   | M16014-09-011-2-L | M16014-09-011-3-L | M16014-09-011-4-L |
| 16 Pin        | 常规        | M16016-09-011-1-L   | M16016-09-011-2-L | M16016-09-011-3-L | M16016-09-011-4-L |
| 19 Pin        | 常规        | M16019-09-011-1-L   | M16019-09-011-2-L | M16019-09-011-3-L | M16019-09-011-4-L |
| 24 Pin        | 常规        | M16024-09-011-1-L   | M16024-09-011-2-L | M16024-09-011-3-L | M16024-09-011-4-L |

技术参数 / Specifications

| 芯数 / Pin   | 02 Pin  | 03 Pin | 04 Pin | 05 Pin | 06 Pin | 07 Pin | 08 Pin | 12 Pin | 14 Pin | 16 Pin | 19 Pin | 24 Pin |
|--|---|--------|--------|--------|--------|--------|--------|--------|--------|--------|--------|--------|
| 额定电流 / Rated current                                 | 7 A   | 7 A    | 6 A    | 6 A    | 5 A    | 5 A    | 5 A    | 3 A    | 3 A    | 3 A    | 3 A    | 1 A    |
| 额定电压(A/C交流) / Rated voltage                          | 250V  | 250V   | 250V   | 250V   | 250V   | 125V   | 125V   | 60V    | 60V    | 60V    | 60V    | 60V    |
| 额定电压(D/C直流) / Rated voltage                          | 250V  | 250V   | 250V   | 250V   | 250V   | 125V   | 125V   | 60V    | 60V    | 60V    | 60V    | 60V    |
| 线规 (mm <sup>2</sup> ) / Wire gauge(mm <sup>2</sup> ) | 0.75  | 0.75   | 0.75   | 0.75   | 0.75   | 0.75   | 0.75   | 0.25   | 0.25   | 0.25   | 0.25   | 0.14   |
| 线号 (AWG) / Wire gauge(AWG)                           | 20  | 20     | 20     | 20     | 20     | 20     | 20     | 24     | 24     | 24     | 24     | 26     |
| 壳体材料 / Outer shell material                          | 黄铜合金镀镍/PA+GF / Copper Alloy With Nickel Plated/PA+GF                  |        |        |        |        |        |        |        |        |        |        |        |
| 胶芯材料 / Housing material                              | PA+GF/TPU   |        |        |        |        |        |        |        |        |        |        |        |
| 成型材料 / Molding material                              | TPU/PVC   |        |        |        |        |        |        |        |        |        |        |        |
| 端子材料 / Pin material                                  | 黄铜镀金/磷铜镀金 / Brass With Gold Plated / Phosphor Bronze With Gold Plated |        |        |        |        |        |        |        |        |        |        |        |
| 适用温度 / Applicable temperature                        | -20 °C ~ +80 °C   |        |        |        |        |        |        |        |        |        |        |        |
| 绝缘电阻 / Insulation resistance                         | ≥ 100MΩ   |        |        |        |        |        |        |        |        |        |        |        |
| 接触电阻 / Contact resistance                            | ≤ 5mΩ   |        |        |        |        |        |        |        |        |        |        |        |
| 防护等级 / Degree of protection                          | IP67 / IP68   |        |        |        |        |        |        |        |        |        |        |        |
| 插拔次数 / Mechanical durability                         | ≥ 500次  |        |        |        |        |        |        |        |        |        |        |        |
| 线材 / Wire rod  | PVC/PUR   |        |        |        |        |        |        |        |        |        |        |        |

## M16母弯头成型式线束 屏蔽/非屏蔽 线长L可定制

产品图 / Product photo



尺寸图 / Dimension

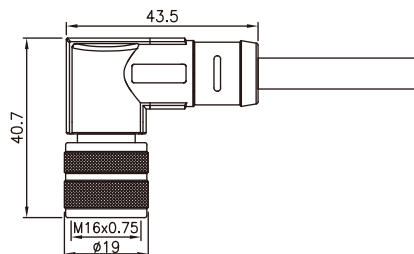

针位分布前视图 / Pin assignment front view

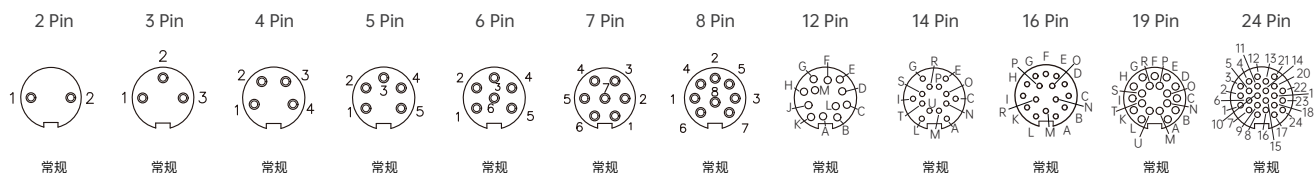

订货信息 / Order deaa

| 芯数 / Contacts | 编码 / Code | 产品料号("L"表示长度, 单位毫米mm) / Part number ("L" is length millimetre mm) |                   |                   |                   |
|---------------|-----------|---|-------------------|-------------------|-------------------|
|               |           | 1: PVC 无屏蔽  | 2: PUR 无屏蔽        | 3: PVC 带屏蔽        | 4: PUR 带屏蔽        |
| 02 Pin        | 常规        | M16002-10-011-1-L   | M16002-10-011-2-L | M16002-10-011-3-L | M16002-10-011-4-L |
| 03 Pin        | 常规        | M16003-10-011-1-L   | M16003-10-011-2-L | M16003-10-011-3-L | M16003-10-011-4-L |
| 04 Pin        | 常规        | M16004-10-011-1-L   | M16004-10-011-2-L | M16004-10-011-3-L | M16004-10-011-4-L |
| 05 Pin        | 常规        | M16005-10-011-1-L   | M16005-10-011-2-L | M16005-10-011-3-L | M16005-10-011-4-L |
| 06 Pin        | 常规        | M16006-10-011-1-L   | M16006-10-011-2-L | M16006-10-011-3-L | M16006-10-011-4-L |
| 07 Pin        | 常规        | M16007-10-011-1-L   | M16007-10-011-2-L | M16007-10-011-3-L | M16007-10-011-4-L |
| 08 Pin        | 常规        | M16008-10-011-1-L   | M16008-10-011-2-L | M16008-10-011-3-L | M16008-10-011-4-L |
| 12 Pin        | 常规        | M16012-10-011-1-L   | M16012-10-011-2-L | M16012-10-011-3-L | M16012-10-011-4-L |
| 14 Pin        | 常规        | M16014-10-011-1-L   | M16014-10-011-2-L | M16014-10-011-3-L | M16014-10-011-4-L |
| 16 Pin        | 常规        | M16016-10-011-1-L   | M16016-10-011-2-L | M16016-10-011-3-L | M16016-10-011-4-L |
| 19 Pin        | 常规        | M16019-10-011-1-L   | M16019-10-011-2-L | M16019-10-011-3-L | M16019-10-011-4-L |
| 24 Pin        | 常规        | M16024-10-011-1-L   | M16019-10-011-2-L | M16019-10-011-3-L | M16019-10-011-4-L |

技术参数 / Specifications

| 芯数 / Pin   | 02 Pin  | 03 Pin | 04 Pin | 05 Pin | 06 Pin | 07 Pin | 08 Pin | 12 Pin | 14 Pin | 16 Pin | 19 Pin | 24 Pin |
|--|---|--------|--------|--------|--------|--------|--------|--------|--------|--------|--------|--------|
| 额定电流 / Rated current                                 | 7 A   | 7 A    | 6 A    | 6 A    | 5 A    | 5 A    | 5 A    | 3 A    | 3 A    | 3 A    | 3 A    | 1 A    |
| 额定电压(A/C交流) / Rated voltage                          | 250V  | 250V   | 250V   | 250V   | 250V   | 125V   | 125V   | 60V    | 60V    | 60V    | 60V    | 60V    |
| 额定电压(D/C直流) / Rated voltage                          | 250V  | 250V   | 250V   | 250V   | 250V   | 125V   | 125V   | 60V    | 60V    | 60V    | 60V    | 60V    |
| 线规 (mm <sup>2</sup> ) / Wire gauge(mm <sup>2</sup> ) | 0.75  | 0.75   | 0.75   | 0.75   | 0.75   | 0.75   | 0.75   | 0.25   | 0.25   | 0.25   | 0.25   | 0.14   |
| 线号 (AWG) / Wire gauge(AWG)                           | 20  | 20     | 20     | 20     | 20     | 20     | 20     | 24     | 24     | 24     | 24     | 26     |
| 壳体材料 / Outer shell material                          | 黄铜合金镀镍/PA+GF / Copper Alloy With Nickel Plated/PA+GF                  |        |        |        |        |        |        |        |        |        |        |        |
| 胶芯材料 / Housing material                              | PA+GF/TPU   |        |        |        |        |        |        |        |        |        |        |        |
| 成型材料 / Molding material                              | TPU/PVC   |        |        |        |        |        |        |        |        |        |        |        |
| 端子材料 / Pin material                                  | 黄铜镀金/磷铜镀金 / Brass With Gold Plated / Phosphor Bronze With Gold Plated |        |        |        |        |        |        |        |        |        |        |        |
| 适用温度 / Applicable temperature                        | -20 °C ~ +80 °C   |        |        |        |        |        |        |        |        |        |        |        |
| 绝缘电阻 / Insulation resistance                         | ≥ 100MΩ   |        |        |        |        |        |        |        |        |        |        |        |
| 接触电阻 / Contact resistance                            | ≤ 5mΩ   |        |        |        |        |        |        |        |        |        |        |        |
| 防护等级 / Degree of protection                          | IP67 / IP68   |        |        |        |        |        |        |        |        |        |        |        |
| 插拔次数 / Mechanical durability                         | ≥ 500次  |        |        |        |        |        |        |        |        |        |        |        |
| 线材 / Wire rod  | PVC/PUR   |        |        |        |        |        |        |        |        |        |        |        |

## M23公直头信号金属款组装式插头 压接型PG

产品图 / Product photo



尺寸图 / Dimension

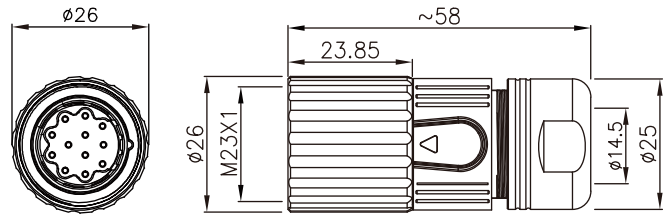

针位分布前视图 / Pin assignment front view

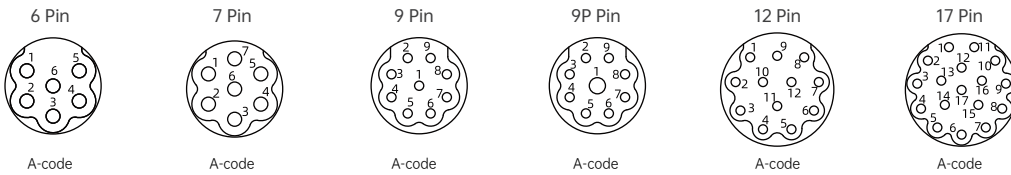

订货信息 / Order daec

| 芯数 / Number of cores | Coding | 料号 / Part number |
|----------------------|--------|------------------|
| 06 Pin               | A-code | M23A06-01-010    |
| 07 Pin               | A-code | M23A07-01-010    |
| 09Pin                | A-code | M23A09-01-010    |
| 09P(8+1) Pin         | A-code | M23A09P-01-010   |
| 12 Pin               | A-code | M23A12-01-010    |
| 17 Pin               | A-code | M23A17-01-010    |

技术参数 / Specifications

| 芯数 / Pin   | 06 Pin  | 07 Pin             | 09 Pin           | 09P(8+1) Pin                          | 12 Pin           | 17 Pin           |
|--|---|--------------------|------------------|---------------------------------------|------------------|------------------|
| 额定电流 / Rated current                                 | 20 A  | 20 A               | 8 A              | 8A / 20A                              | 8 A              | 8 A              |
| 额定电压(A/C交流) / Rated voltage                          | 300V  | 300V               | 150V             | 300V                                  | 150V             | 150V             |
| 额定电压(D/C直流) / Rated voltage                          | 300V  | 300V               | 150V             | 150V                                  | 150V             | 150V             |
| 线规 (mm <sup>2</sup> ) / Wire gauge(mm <sup>2</sup> ) | 2.5mm <sup>2</sup>  | 2.5mm <sup>2</sup> | 1mm <sup>2</sup> | 1mm <sup>2</sup> / 2.5mm <sup>2</sup> | 1mm <sup>2</sup> | 1mm <sup>2</sup> |
| 线号 (AWG) / Wire gauge(AWG)                           | 14AWG   | 14AWG              | 18AWG            | 18AWG / 14AWG                         | 18AWG            | 18AWG            |
| 壳体材料 / Outer shell material                          | 黄铜合金镀镍/PA+GF / Copper Alloy With Nickel Plated/PA+GF                  |                    |                  |                                       |                  |                  |
| 胶芯材料 / Housing material                              | PBT/PA66  |                    |                  |                                       |                  |                  |
| 成型材料 / Molding material                              | TPU/PVC   |                    |                  |                                       |                  |                  |
| 端子材料 / Pin material                                  | 黄铜镀金/磷铜镀金 / Brass With Gold Plated / Phosphor Bronze With Gold Plated |                    |                  |                                       |                  |                  |
| 适用温度 / Applicable temperature                        | -40 °C ~ +125 °C  |                    |                  |                                       |                  |                  |
| 绝缘电阻 / Insulation resistance                         | ≥ 100MΩ   |                    |                  |                                       |                  |                  |
| 接触电阻 / Contact resistance                            | ≤ 5mΩ   |                    |                  |                                       |                  |                  |
| 防护等级 / Degree of protection                          | IP67  |                    |                  |                                       |                  |                  |
| 插拔次数 / Mechanical durability                         | ≥ 500次  |                    |                  |                                       |                  |                  |
| 线材 / Wire rod  | PVC/PUR   |                    |                  |                                       |                  |                  |
| 接线范围 / Wire bound                                    | Φ6mm~Φ10mm  |                    |                  |                                       |                  |                  |



## M23母直头信号金属款组装式插头 压接型PG

产品图 / Product photo



尺寸图 / Dimension

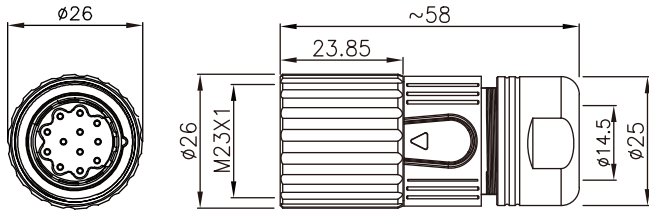

针位分布前视图 / Pin assignment front view

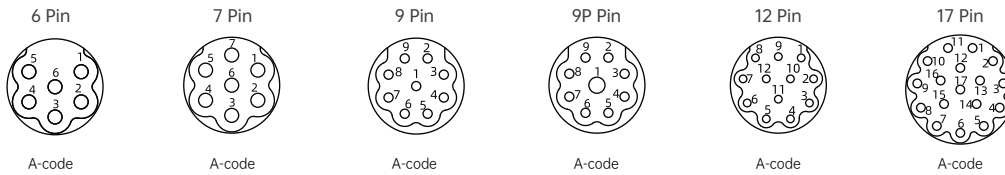

订货信息 / Order daec

| 芯数 / Number of cores | Coding | 料号 / Part number |
|----------------------|--------|------------------|
| 06 Pin               | A-code | M23A06-02-010    |
| 07 Pin               | A-code | M23A07-02-010    |
| 09Pin                | A-code | M23A09-02-010    |
| 09P(8+1) Pin         | A-code | M23A09P-02-010   |
| 12 Pin               | A-code | M23A12-02-010    |
| 17 Pin               | A-code | M23A17-02-010    |

技术参数 / Specifications

| 芯数 / Pin   | 06 Pin  | 07 Pin             | 09 Pin           | 09P(8+1) Pin                          | 12 Pin           | 17 Pin           |
|--|---|--------------------|------------------|---------------------------------------|------------------|------------------|
| 额定电流 / Rated current                                 | 20 A  | 20 A               | 8 A              | 8A / 20A                              | 8 A              | 8 A              |
| 额定电压(A/C交流) / Rated voltage                          | 300V  | 300V               | 150V             | 300V                                  | 150V             | 150V             |
| 额定电压(D/C直流) / Rated voltage                          | 300V  | 300V               | 150V             | 150V                                  | 150V             | 150V             |
| 线规 (mm <sup>2</sup> ) / Wire gauge(mm <sup>2</sup> ) | 2.5mm <sup>2</sup>  | 2.5mm <sup>2</sup> | 1mm <sup>2</sup> | 1mm <sup>2</sup> / 2.5mm <sup>2</sup> | 1mm <sup>2</sup> | 1mm <sup>2</sup> |
| 线号 (AWG) / Wire gauge(AWG)                           | 14AWG   | 14AWG              | 18AWG            | 18AWG / 14AWG                         | 18AWG            | 18AWG            |
| 壳体材料 / Outer shell material                          | 黄铜合金镀镍/PA+GF / Copper Alloy With Nickel Plated/PA+GF                  |                    |                  |                                       |                  |                  |
| 胶芯材料 / Housing material                              | PBT/PA66  |                    |                  |                                       |                  |                  |
| 成型材料 / Molding material                              | TPU/PVC   |                    |                  |                                       |                  |                  |
| 端子材料 / Pin material                                  | 黄铜镀金/磷铜镀金 / Brass With Gold Plated / Phosphor Bronze With Gold Plated |                    |                  |                                       |                  |                  |
| 适用温度 / Applicable temperature                        | -40 °C ~ +125 °C  |                    |                  |                                       |                  |                  |
| 绝缘电阻 / Insulation resistance                         | ≥ 100MΩ   |                    |                  |                                       |                  |                  |
| 接触电阻 / Contact resistance                            | ≤ 5mΩ   |                    |                  |                                       |                  |                  |
| 防护等级 / Degree of protection                          | IP67  |                    |                  |                                       |                  |                  |
| 插拔次数 / Mechanical durability                         | ≥ 500次  |                    |                  |                                       |                  |                  |
| 线材 / Wire rod  | PVC/PUR   |                    |                  |                                       |                  |                  |
| 接线范围 / Wire bound                                    | Φ6mm-Φ10mm  |                    |                  |                                       |                  |                  |

## M23公直头信号组 组装式对接插头 压接型PG

产品图 / Product photo



尺寸图 / Dimension

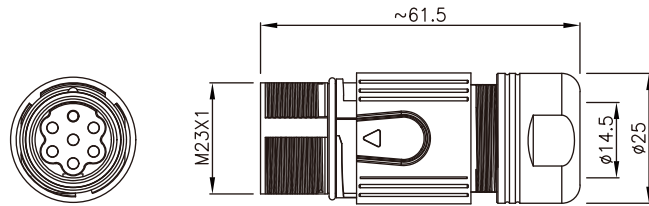

针位分布前视图 / Pin assignment front view

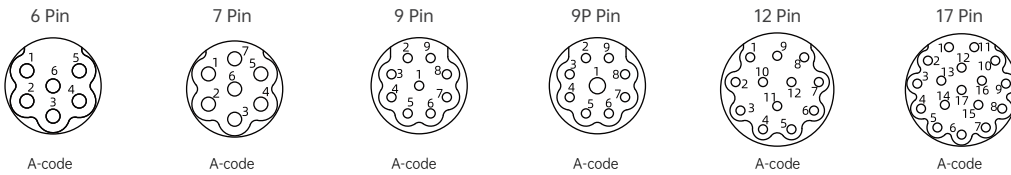

订货信息 / Order daec

| 芯数 / Number of cores | Coding | 料号 / Part number |
|----------------------|--------|------------------|
| 06 Pin               | A-code | M23A06-01-011    |
| 07 Pin               | A-code | M23A07-01-011    |
| 09Pin                | A-code | M23A09-01-011    |
| 09P(8+1) Pin         | A-code | M23A09P-01-011   |
| 12 Pin               | A-code | M23A12-01-011    |
| 17 Pin               | A-code | M23A17-01-011    |

技术参数 / Specifications

| 芯数 / Pin   | 06 Pin  | 07 Pin             | 09 Pin           | 09P(8+1) Pin                          | 12 Pin           | 17 Pin           |
|--|---|--------------------|------------------|---------------------------------------|------------------|------------------|
| 额定电流 / Rated current                                 | 20 A  | 20 A               | 8 A              | 8A / 20A                              | 8 A              | 8 A              |
| 额定电压(A/C交流) / Rated voltage                          | 300V  | 300V               | 150V             | 300V                                  | 150V             | 150V             |
| 额定电压(D/C直流) / Rated voltage                          | 300V  | 300V               | 150V             | 150V                                  | 150V             | 150V             |
| 线规 (mm <sup>2</sup> ) / Wire gauge(mm <sup>2</sup> ) | 2.5mm <sup>2</sup>  | 2.5mm <sup>2</sup> | 1mm <sup>2</sup> | 1mm <sup>2</sup> / 2.5mm <sup>2</sup> | 1mm <sup>2</sup> | 1mm <sup>2</sup> |
| 线号 (AWG) / Wire gauge(AWG)                           | 14AWG   | 14AWG              | 18AWG            | 18AWG / 14AWG                         | 18AWG            | 18AWG            |
| 壳体材料 / Outer shell material                          | 黄铜合金镀镍/PA+GF / Copper Alloy With Nickel Plated/PA+GF                  |                    |                  |                                       |                  |                  |
| 胶芯材料 / Housing material                              | PBT/PA66  |                    |                  |                                       |                  |                  |
| 成型材料 / Molding material                              | TPU/PVC   |                    |                  |                                       |                  |                  |
| 端子材料 / Pin material                                  | 黄铜镀金/磷铜镀金 / Brass With Gold Plated / Phosphor Bronze With Gold Plated |                    |                  |                                       |                  |                  |
| 适用温度 / Applicable temperature                        | -40 °C ~ +125 °C  |                    |                  |                                       |                  |                  |
| 绝缘电阻 / Insulation resistance                         | ≥ 100MΩ   |                    |                  |                                       |                  |                  |
| 接触电阻 / Contact resistance                            | ≤ 5mΩ   |                    |                  |                                       |                  |                  |
| 防护等级 / Degree of protection                          | IP67  |                    |                  |                                       |                  |                  |
| 插拔次数 / Mechanical durability                         | ≥ 500次  |                    |                  |                                       |                  |                  |
| 线材 / Wire rod  | PVC/PUR   |                    |                  |                                       |                  |                  |
| 接线范围 / Wire bound                                    | Φ6mm~Φ10mm  |                    |                  |                                       |                  |                  |

## M23母直头信号组装式对接插头 压接型PG

产品图 / Product photo



尺寸图 / Dimension

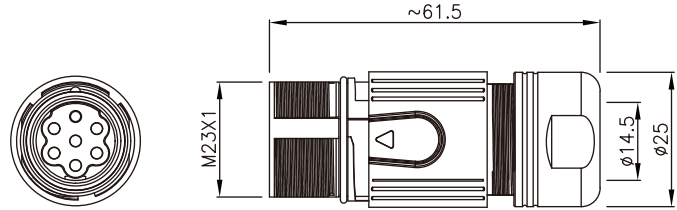

针位分布前视图 / Pin assignment front view

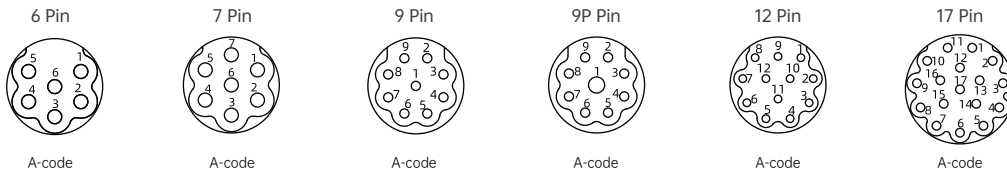

订货信息 / Order daec

| 芯数 / Number of cores | Coding | 料号 / Part number |
|----------------------|--------|------------------|
| 06 Pin               | A-code | M23A06-02-011    |
| 07 Pin               | A-code | M23A07-02-011    |
| 09Pin                | A-code | M23A09-02-011    |
| 09P(8+1) Pin         | A-code | M23A09P-02-011   |
| 12 Pin               | A-code | M23A12-02-011    |
| 17 Pin               | A-code | M23A17-02-011    |

技术参数 / Specifications

| 芯数 / Pin   | 06 Pin  | 07 Pin             | 09 Pin           | 09P(8+1) Pin                          | 12 Pin           | 17 Pin           |
|--|---|--------------------|------------------|---------------------------------------|------------------|------------------|
| 额定电流 / Rated current                                 | 20 A  | 20 A               | 8 A              | 8A / 20A                              | 8 A              | 8 A              |
| 额定电压(A/C交流) / Rated voltage                          | 300V  | 300V               | 150V             | 300V                                  | 150V             | 150V             |
| 额定电压(D/C直流) / Rated voltage                          | 300V  | 300V               | 150V             | 150V                                  | 150V             | 150V             |
| 线规 (mm <sup>2</sup> ) / Wire gauge(mm <sup>2</sup> ) | 2.5mm <sup>2</sup>  | 2.5mm <sup>2</sup> | 1mm <sup>2</sup> | 1mm <sup>2</sup> / 2.5mm <sup>2</sup> | 1mm <sup>2</sup> | 1mm <sup>2</sup> |
| 线号 (AWG) / Wire gauge(AWG)                           | 14AWG   | 14AWG              | 18AWG            | 18AWG / 14AWG                         | 18AWG            | 18AWG            |
| 壳体材料 / Outer shell material                          | 黄铜合金镀镍/PA+GF / Copper Alloy With Nickel Plated/PA+GF                  |                    |                  |                                       |                  |                  |
| 胶芯材料 / Housing material                              | PBT/PA66  |                    |                  |                                       |                  |                  |
| 成型材料 / Molding material                              | TPU/PVC   |                    |                  |                                       |                  |                  |
| 端子材料 / Pin material                                  | 黄铜镀金/磷铜镀金 / Brass With Gold Plated / Phosphor Bronze With Gold Plated |                    |                  |                                       |                  |                  |
| 适用温度 / Applicable temperature                        | -40 °C ~ +125 °C  |                    |                  |                                       |                  |                  |
| 绝缘电阻 / Insulation resistance                         | ≥ 100MΩ   |                    |                  |                                       |                  |                  |
| 接触电阻 / Contact resistance                            | ≤ 5mΩ   |                    |                  |                                       |                  |                  |
| 防护等级 / Degree of protection                          | IP67  |                    |                  |                                       |                  |                  |
| 插拔次数 / Mechanical durability                         | ≥ 500次  |                    |                  |                                       |                  |                  |
| 线材 / Wire rod  | PVC/PUR   |                    |                  |                                       |                  |                  |
| 接线范围 / Wire bound                                    | Φ6mm~Φ10mm  |                    |                  |                                       |                  |                  |

## M23公直头信号组装式方形法兰插座 压接型 安装孔19.8x19.8

产品图 / Product photo



尺寸图 / Dimension

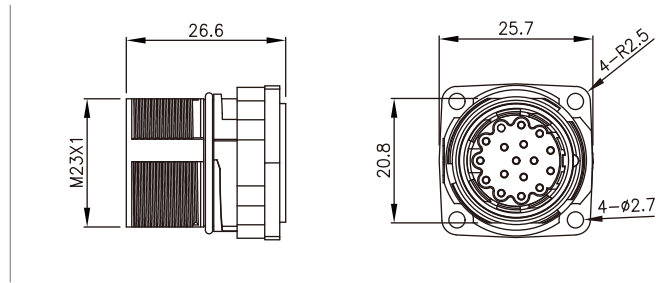

针位分布前视图 / Pin assignment front view

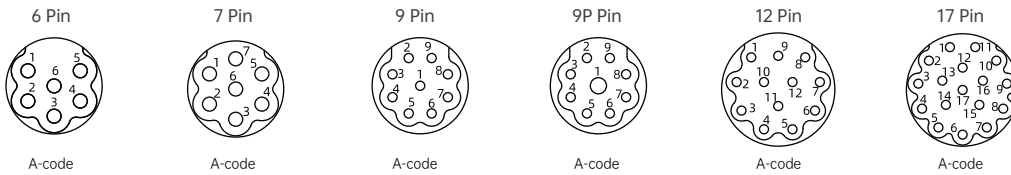

订货信息 / Order daec

| 芯数 / Number of cores | Coding | 料号 / Part number |
|----------------------|--------|------------------|
| 06 Pin               | A-code | M23A06-01-014    |
| 07 Pin               | A-code | M23A07-01-014    |
| 09Pin                | A-code | M23A09-01-014    |
| 09P(8+1) Pin         | A-code | M23A09P-01-014   |
| 12 Pin               | A-code | M23A12-01-014    |
| 17 Pin               | A-code | M23A17-01-014    |

技术参数 / Specifications

| 芯数 / Pin   | 06 Pin  | 07 Pin             | 09 Pin           | 09P(8+1) Pin                          | 12 Pin           | 17 Pin           |
|--|---|--------------------|------------------|---------------------------------------|------------------|------------------|
| 额定电流 / Rated current                                 | 20 A  | 20 A               | 8 A              | 8A / 20A                              | 8 A              | 8 A              |
| 额定电压(A/C交流) / Rated voltage                          | 300V  | 300V               | 150V             | 300V                                  | 150V             | 150V             |
| 额定电压(D/C直流) / Rated voltage                          | 300V  | 300V               | 150V             | 150V                                  | 150V             | 150V             |
| 线规 (mm <sup>2</sup> ) / Wire gauge(mm <sup>2</sup> ) | 2.5mm <sup>2</sup>  | 2.5mm <sup>2</sup> | 1mm <sup>2</sup> | 1mm <sup>2</sup> / 2.5mm <sup>2</sup> | 1mm <sup>2</sup> | 1mm <sup>2</sup> |
| 线号 (AWG) / Wire gauge(AWG)                           | 14AWG   | 14AWG              | 18AWG            | 18AWG / 14AWG                         | 18AWG            | 18AWG            |
| 壳体材料 / Outer shell material                          | 黄铜合金镀镍/PA+GF / Copper Alloy With Nickel Plated/PA+GF                  |                    |                  |                                       |                  |                  |
| 胶芯材料 / Housing material                              | PBT/PA66  |                    |                  |                                       |                  |                  |
| 成型材料 / Molding material                              | TPU/PVC   |                    |                  |                                       |                  |                  |
| 端子材料 / Pin material                                  | 黄铜镀金/磷铜镀金 / Brass With Gold Plated / Phosphor Bronze With Gold Plated |                    |                  |                                       |                  |                  |
| 适用温度 / Applicable temperature                        | -40 °C ~ +125 °C  |                    |                  |                                       |                  |                  |
| 绝缘电阻 / Insulation resistance                         | ≥ 100MΩ   |                    |                  |                                       |                  |                  |
| 接触电阻 / Contact resistance                            | ≤ 5mΩ   |                    |                  |                                       |                  |                  |
| 防护等级 / Degree of protection                          | IP67  |                    |                  |                                       |                  |                  |
| 插拔次数 / Mechanical durability                         | ≥ 500次  |                    |                  |                                       |                  |                  |
| 线材 / Wire rod  | PVC/PUR   |                    |                  |                                       |                  |                  |

## M23母直头信号组装式方形法兰插座 压接型 安装孔19.8x19.8

产品图 / Product photo



尺寸图 / Dimension

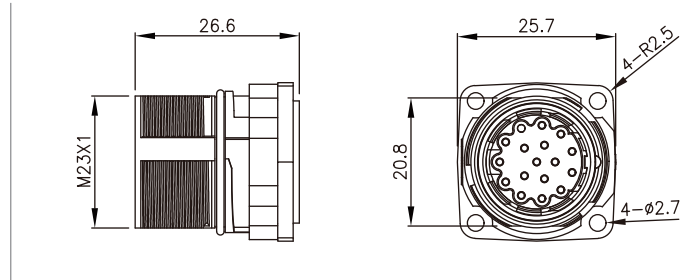

针位分布前视图 / Pin assignment front view

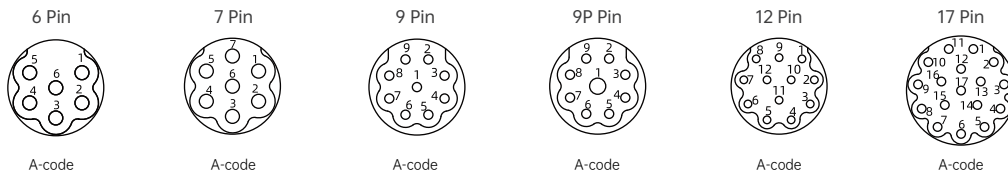

订货信息 / Order daec

| 芯数 / Number of cores | Coding | 料号 / Part number |
|----------------------|--------|------------------|
| 06 Pin               | A-code | M23A06-02-014    |
| 07 Pin               | A-code | M23A07-02-014    |
| 09Pin                | A-code | M23A09-02-014    |
| 09P(8+1) Pin         | A-code | M23A09P-02-014   |
| 12 Pin               | A-code | M23A12-02-014    |
| 17 Pin               | A-code | M23A17-02-014    |

技术参数 / Specifications

| 芯数 / Pin   | 06 Pin  | 07 Pin             | 09 Pin           | 09P(8+1) Pin                          | 12 Pin           | 17 Pin           |
|--|---|--------------------|------------------|---------------------------------------|------------------|------------------|
| 额定电流 / Rated current                                 | 20 A  | 20 A               | 8 A              | 8A / 20A                              | 8 A              | 8 A              |
| 额定电压(A/C交流) / Rated voltage                          | 300V  | 300V               | 150V             | 300V                                  | 150V             | 150V             |
| 额定电压(D/C直流) / Rated voltage                          | 300V  | 300V               | 150V             | 150V                                  | 150V             | 150V             |
| 线规 (mm <sup>2</sup> ) / Wire gauge(mm <sup>2</sup> ) | 2.5mm <sup>2</sup>  | 2.5mm <sup>2</sup> | 1mm <sup>2</sup> | 1mm <sup>2</sup> / 2.5mm <sup>2</sup> | 1mm <sup>2</sup> | 1mm <sup>2</sup> |
| 线号 (AWG) / Wire gauge(AWG)                           | 14AWG   | 14AWG              | 18AWG            | 18AWG / 14AWG                         | 18AWG            | 18AWG            |
| 壳体材料 / Outer shell material                          | 黄铜合金镀镍/PA+GF / Copper Alloy With Nickel Plated/PA+GF                  |                    |                  |                                       |                  |                  |
| 胶芯材料 / Housing material                              | PBT/PA66  |                    |                  |                                       |                  |                  |
| 成型材料 / Molding material                              | TPU/PVC   |                    |                  |                                       |                  |                  |
| 端子材料 / Pin material                                  | 黄铜镀金/磷铜镀金 / Brass With Gold Plated / Phosphor Bronze With Gold Plated |                    |                  |                                       |                  |                  |
| 适用温度 / Applicable temperature                        | -40 °C ~ +125 °C  |                    |                  |                                       |                  |                  |
| 绝缘电阻 / Insulation resistance                         | ≥ 100MΩ   |                    |                  |                                       |                  |                  |
| 接触电阻 / Contact resistance                            | ≤ 5mΩ   |                    |                  |                                       |                  |                  |
| 防护等级 / Degree of protection                          | IP67  |                    |                  |                                       |                  |                  |
| 插拔次数 / Mechanical durability                         | ≥ 500次  |                    |                  |                                       |                  |                  |
| 线材 / Wire rod  | PVC/PUR   |                    |                  |                                       |                  |                  |

## M23公弯头信号组装式方形法兰插座 压接型 安装孔19.8x19.8

产品图 / Product photo



尺寸图 / Dimension

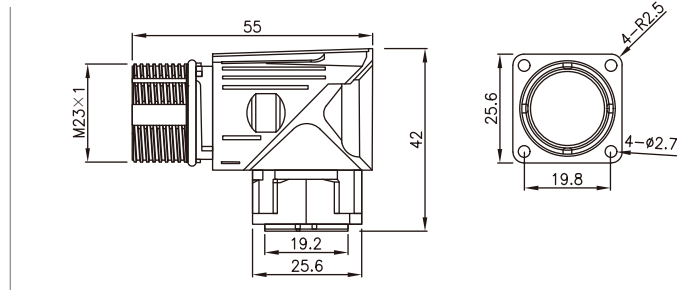

针位分布前视图 / Pin assignment front view

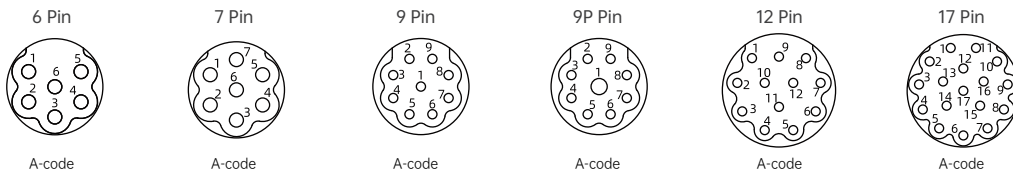

订货信息 / Order daea

| 芯数 / Number of cores | Coding | 料号 / Part number |
|----------------------|--------|------------------|
| 06 Pin               | A-code | M23A06-01-015    |
| 07 Pin               | A-code | M23A07-01-015    |
| 09Pin                | A-code | M23A09-01-015    |
| 09P(8+1) Pin         | A-code | M23A09P-01-015   |
| 12 Pin               | A-code | M23A12-01-015    |
| 17 Pin               | A-code | M23A17-01-015    |

技术参数 / Specifications

| 芯数 / Pin   | 06 Pin  | 07 Pin             | 09 Pin           | 09P(8+1) Pin                          | 12 Pin           | 17 Pin           |
|--|---|--------------------|------------------|---------------------------------------|------------------|------------------|
| 额定电流 / Rated current                                 | 20 A  | 20 A               | 8 A              | 8A / 20A                              | 8 A              | 8 A              |
| 额定电压(A/C交流) / Rated voltage                          | 300V  | 300V               | 150V             | 300V                                  | 150V             | 150V             |
| 额定电压(D/C直流) / Rated voltage                          | 300V  | 300V               | 150V             | 150V                                  | 150V             | 150V             |
| 线规 (mm <sup>2</sup> ) / Wire gauge(mm <sup>2</sup> ) | 2.5mm <sup>2</sup>  | 2.5mm <sup>2</sup> | 1mm <sup>2</sup> | 1mm <sup>2</sup> / 2.5mm <sup>2</sup> | 1mm <sup>2</sup> | 1mm <sup>2</sup> |
| 线号 (AWG) / Wire gauge(AWG)                           | 14AWG   | 14AWG              | 18AWG            | 18AWG / 14AWG                         | 18AWG            | 18AWG            |
| 壳体材料 / Outer shell material                          | 黄铜合金镀镍/PA+GF / Copper Alloy With Nickel Plated/PA+GF                  |                    |                  |                                       |                  |                  |
| 胶芯材料 / Housing material                              | PBT/PA66  |                    |                  |                                       |                  |                  |
| 成型材料 / Molding material                              | TPU/PVC   |                    |                  |                                       |                  |                  |
| 端子材料 / Pin material                                  | 黄铜镀金/磷铜镀金 / Brass With Gold Plated / Phosphor Bronze With Gold Plated |                    |                  |                                       |                  |                  |
| 适用温度 / Applicable temperature                        | -40 °C ~ +125 °C  |                    |                  |                                       |                  |                  |
| 绝缘电阻 / Insulation resistance                         | ≥ 100MΩ   |                    |                  |                                       |                  |                  |
| 接触电阻 / Contact resistance                            | ≤ 5mΩ   |                    |                  |                                       |                  |                  |
| 防护等级 / Degree of protection                          | IP67  |                    |                  |                                       |                  |                  |
| 插拔次数 / Mechanical durability                         | ≥ 500次  |                    |                  |                                       |                  |                  |
| 线材 / Wire rod  | PVC/PUR   |                    |                  |                                       |                  |                  |

## M23母弯头信号组装式方形法兰插座 压接型 安装孔19.8x19.8

产品图 / Product photo



尺寸图 / Dimension

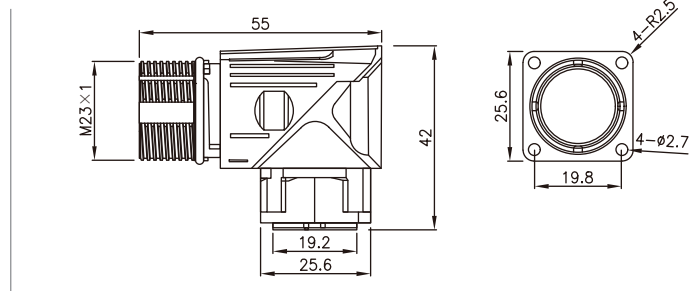

针位分布前视图 / Pin assignment front view

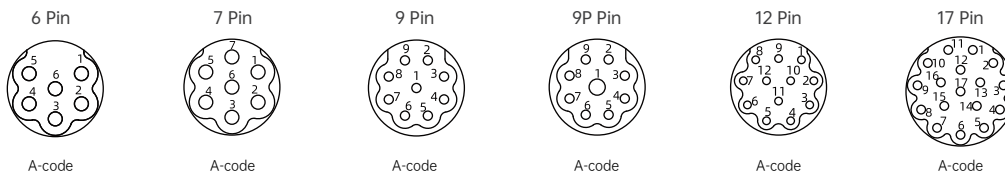

订货信息 / Order daea

| 芯数 / Number of cores | Coding | 料号 / Part number |
|----------------------|--------|------------------|
| 06 Pin               | A-code | M23A06-02-015    |
| 07 Pin               | A-code | M23A07-02-015    |
| 09Pin                | A-code | M23A09-02-015    |
| 09P(8+1) Pin         | A-code | M23A09P-02-015   |
| 12 Pin               | A-code | M23A12-02-015    |
| 17 Pin               | A-code | M23A17-02-015    |

技术参数 / Specifications

| 芯数 / Pin   | 06 Pin  | 07 Pin             | 09 Pin           | 09P(8+1) Pin                          | 12 Pin           | 17 Pin           |
|--|---|--------------------|------------------|---------------------------------------|------------------|------------------|
| 额定电流 / Rated current                                 | 20 A  | 20 A               | 8 A              | 8A / 20A                              | 8 A              | 8 A              |
| 额定电压(A/C交流) / Rated voltage                          | 300V  | 300V               | 150V             | 300V                                  | 150V             | 150V             |
| 额定电压(D/C直流) / Rated voltage                          | 300V  | 300V               | 150V             | 150V                                  | 150V             | 150V             |
| 线规 (mm <sup>2</sup> ) / Wire gauge(mm <sup>2</sup> ) | 2.5mm <sup>2</sup>  | 2.5mm <sup>2</sup> | 1mm <sup>2</sup> | 1mm <sup>2</sup> / 2.5mm <sup>2</sup> | 1mm <sup>2</sup> | 1mm <sup>2</sup> |
| 线号 (AWG) / Wire gauge(AWG)                           | 14AWG   | 14AWG              | 18AWG            | 18AWG / 14AWG                         | 18AWG            | 18AWG            |
| 壳体材料 / Outer shell material                          | 黄铜合金镀镍/PA+GF / Copper Alloy With Nickel Plated/PA+GF                  |                    |                  |                                       |                  |                  |
| 胶芯材料 / Housing material                              | PBT/PA66  |                    |                  |                                       |                  |                  |
| 成型材料 / Molding material                              | TPU/PVC   |                    |                  |                                       |                  |                  |
| 端子材料 / Pin material                                  | 黄铜镀金/磷铜镀金 / Brass With Gold Plated / Phosphor Bronze With Gold Plated |                    |                  |                                       |                  |                  |
| 适用温度 / Applicable temperature                        | -40 °C ~ +125 °C  |                    |                  |                                       |                  |                  |
| 绝缘电阻 / Insulation resistance                         | ≥ 100MΩ   |                    |                  |                                       |                  |                  |
| 接触电阻 / Contact resistance                            | ≤ 5mΩ   |                    |                  |                                       |                  |                  |
| 防护等级 / Degree of protection                          | IP67  |                    |                  |                                       |                  |                  |
| 插拔次数 / Mechanical durability                         | ≥ 500次  |                    |                  |                                       |                  |                  |
| 线材 / Wire rod  | PVC/PUR   |                    |                  |                                       |                  |                  |

## M23公弯头电源组装式方形法兰插座 压接型 安装孔19.8x19.8

产品图 / Product photo



尺寸图 / Dimension

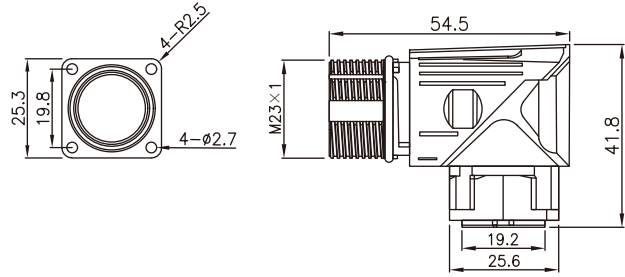

针位分布前视图 / Pin assignment front view

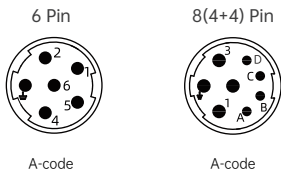

订货信息 / Order daec

| 芯数 / Number of cores | Coding | 料号 / Part number |
|----------------------|--------|------------------|
| 06 Pin               | A-code | M23A04-01-017    |
| 08(4+4) Pin          | A-code | M23A08-01-017    |

技术参数 / Specifications

| 芯数 / Pin   | 06 Pin  | 08(4+4) Pin                           |
|--|---|---------------------------------------|
| 额定电流 / Rated current                                 | 30 A  | 9A / 20A                              |
| 额定电压(A/C交流) / Rated voltage                          | 630V  | 250V / 630V                           |
| 额定电压(D/C直流) / Rated voltage                          | 630V  | 250V / 630V                           |
| 线规 (mm <sup>2</sup> ) / Wire gauge(mm <sup>2</sup> ) | 2.5mm <sup>2</sup>  | 1mm <sup>2</sup> / 2.5mm <sup>2</sup> |
| 线号 (AWG) / Wire gauge(AWG)                           | 14AWG   | 18AWG / 14AWG                         |
| 壳体材料 / Outer shell material                          | 黄铜合金镀镍/PA+GF / Copper Alloy With Nickel Plated/PA+GF                  |                                       |
| 胶芯材料 / Housing material                              | PBT/PA66  |                                       |
| 成型材料 / Molding material                              | TPU/PVC   |                                       |
| 端子材料 / Pin material                                  | 黄铜镀金/磷铜镀金 / Brass With Gold Plated / Phosphor Bronze With Gold Plated |                                       |
| 适用温度 / Applicable temperature                        | -40 °C ~ +125 °C  |                                       |
| 绝缘电阻 / Insulation resistance                         | ≥ 100MΩ   |                                       |
| 接触电阻 / Contact resistance                            | ≤ 5mΩ   |                                       |
| 防护等级 / Degree of protection                          | IP67  |                                       |
| 插拔次数 / Mechanical durability                         | ≥ 500次  |                                       |
| 线材 / Wire rod  | PVC/PUR   |                                       |



## M23母直头电源组装式金属插头 压接型PG

产品图 / Product photo



尺寸图 / Dimension

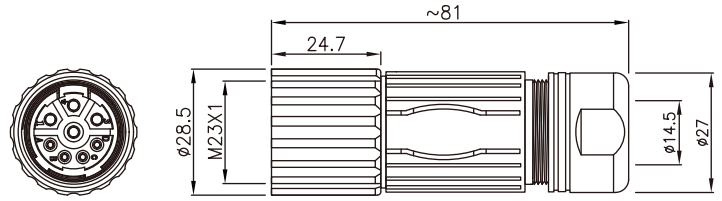

针位分布前视图 / Pin assignment front view

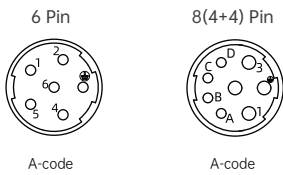

订货信息 / Order daec

| 芯数 / Number of cores | Coding | 料号 / Part number |
|----------------------|--------|------------------|
| 06 Pin               | A-code | M23A06-02-016    |
| 08(4+4) Pin          | A-code | M23A08-02-016    |

技术参数 / Specifications

| 芯数 / Pin   | 06 Pin  | 08(4+4) Pin                           |
|--|---|---------------------------------------|
| 额定电流 / Rated current                                 | 30 A  | 9A / 20A                              |
| 额定电压(A/C交流) / Rated voltage                          | 630V  | 250V / 630V                           |
| 额定电压(D/C直流) / Rated voltage                          | 630V  | 250V / 630V                           |
| 线规 (mm <sup>2</sup> ) / Wire gauge(mm <sup>2</sup> ) | 2.5mm <sup>2</sup>  | 1mm <sup>2</sup> / 2.5mm <sup>2</sup> |
| 线号 (AWG) / Wire gauge(AWG)                           | 14AWG   | 18AWG / 14AWG                         |
| 壳体材料 / Outer shell material                          | 黄铜合金镀镍/PA+GF / Copper Alloy With Nickel Plated/PA+GF                  |                                       |
| 胶芯材料 / Housing material                              | PBT/PA66  |                                       |
| 成型材料 / Molding material                              | TPU/PVC   |                                       |
| 端子材料 / Pin material                                  | 黄铜镀金/磷铜镀金 / Brass With Gold Plated / Phosphor Bronze With Gold Plated |                                       |
| 适用温度 / Applicable temperature                        | -40 °C ~ +125 °C  |                                       |
| 绝缘电阻 / Insulation resistance                         | ≥ 100MΩ   |                                       |
| 接触电阻 / Contact resistance                            | ≤ 5mΩ   |                                       |
| 防护等级 / Degree of protection                          | IP67  |                                       |
| 插拔次数 / Mechanical durability                         | ≥ 500次  |                                       |
| 线材 / Wire rod  | PVC/PUR   |                                       |
| 接线范围 / Wire bound                                    | Φ6mm~Φ10mm  |                                       |

## 7/8前锁面板式公头插座 焊线型螺牙PG13.5

产品图 / Product photo



尺寸图 / Dimension

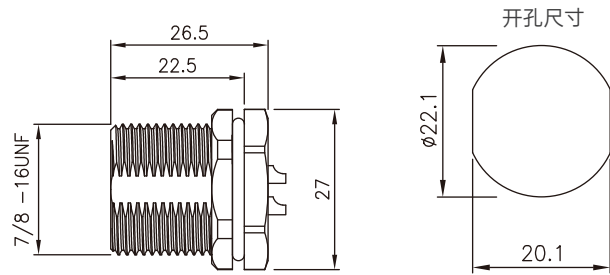

针位分布前视图 / Pin assignment front view

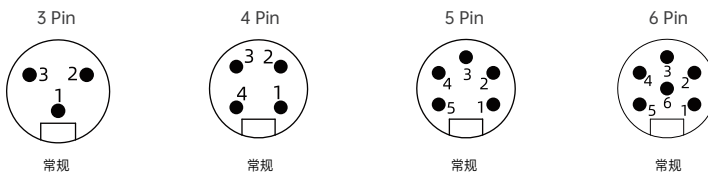

订货信息 / Order daec

| 芯数 / Number of cores | Coding | 料号 / Part number |
|----------------------|--------|------------------|
| 03 Pin               | A-code | M78003-03-003    |
| 04 Pin               | A-code | M78004-03-003    |
| 05 Pin               | A-code | M78005-03-003    |
| 06 Pin               | A-code | M78006-03-003    |

技术参数 / Specifications

| 芯数 / Pin   | 03 Pin  | 04 Pin              | 05 Pin              | 06 Pin              |
|--|---|---------------------|---------------------|---------------------|
| 额定电流 / Rated current                                 | 7 A   | 7 A                 | 6 A                 | 5A                  |
| 额定电压(A/C交流) / Rated voltage                          | 250V  | 250V                | 250V                | 250V                |
| 额定电压(D/C直流) / Rated voltage                          | 250V  | 250V                | 250V                | 250V                |
| 线规 (mm <sup>2</sup> ) / Wire gauge(mm <sup>2</sup> ) | 0.75mm <sup>2</sup>   | 0.75mm <sup>2</sup> | 0.75mm <sup>2</sup> | 0.75mm <sup>2</sup> |
| 线号 (AWG) / Wire gauge(AWG)                           | 20AWG   | 20AWG               | 20AWG               | 20AWG               |
| 壳体材料 / Outer shell material                          | 黄铜合金镀镍/PA+GF / Copper Alloy With Nickel Plated/PA+GF                  |                     |                     |                     |
| 胶芯材料 / Housing material                              | PA+GF/TPU   |                     |                     |                     |
| 成型材料 / Molding material                              | TPU/PVC   |                     |                     |                     |
| 端子材料 / Pin material                                  | 黄铜镀金/磷铜镀金 / Brass With Gold Plated / Phosphor Bronze With Gold Plated |                     |                     |                     |
| 适用温度 / Applicable temperature                        | -20 °C ~ +80 °C   |                     |                     |                     |
| 绝缘电阻 / Insulation resistance                         | ≥ 100MΩ   |                     |                     |                     |
| 接触电阻 / Contact resistance                            | ≤ 5mΩ   |                     |                     |                     |
| 防护等级 / Degree of protection                          | IP67  |                     |                     |                     |
| 插拔次数 / Mechanical durability                         | ≥ 500次  |                     |                     |                     |
| 线材 / Wire rod  | PVC/PUR   |                     |                     |                     |

## 7/8前锁面板式母头插座 焊线型螺牙PG13.5

产品图 / Product photo



尺寸图 / Dimension

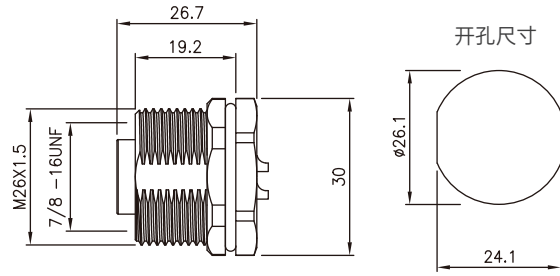

针位分布前视图 / Pin assignment front view

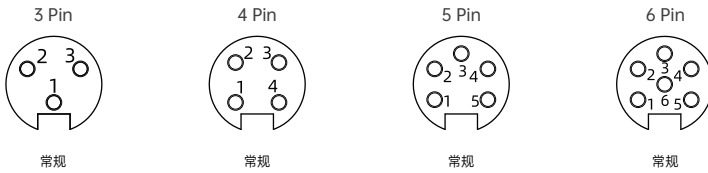

订货信息 / Order daec

| 芯数 / Number of cores | Coding | 料号 / Part number |
|----------------------|--------|------------------|
| 03 Pin               | A-code | M78003-04-003    |
| 04 Pin               | A-code | M78004-04-003    |
| 05 Pin               | A-code | M78005-04-003    |
| 06 Pin               | A-code | M78006-04-003    |

技术参数 / Specifications

| 芯数 / Pin   | 03 Pin  | 04 Pin              | 05 Pin              | 06 Pin              |
|--|---|---------------------|---------------------|---------------------|
| 额定电流 / Rated current                                 | 7 A   | 7 A                 | 6 A                 | 5A                  |
| 额定电压(A/C交流) / Rated voltage                          | 250V  | 250V                | 250V                | 250V                |
| 额定电压(D/C直流) / Rated voltage                          | 250V  | 250V                | 250V                | 250V                |
| 线规 (mm <sup>2</sup> ) / Wire gauge(mm <sup>2</sup> ) | 0.75mm <sup>2</sup>   | 0.75mm <sup>2</sup> | 0.75mm <sup>2</sup> | 0.75mm <sup>2</sup> |
| 线号 (AWG) / Wire gauge(AWG)                           | 20AWG   | 20AWG               | 20AWG               | 20AWG               |
| 壳体材料 / Outer shell material                          | 黄铜合金镀镍/PA+GF / Copper Alloy With Nickel Plated/PA+GF                  |                     |                     |                     |
| 胶芯材料 / Housing material                              | PA+GF/TPU   |                     |                     |                     |
| 成型材料 / Molding material                              | TPU/PVC   |                     |                     |                     |
| 端子材料 / Pin material                                  | 黄铜镀金/磷铜镀金 / Brass With Gold Plated / Phosphor Bronze With Gold Plated |                     |                     |                     |
| 适用温度 / Applicable temperature                        | -20 °C ~ +80 °C   |                     |                     |                     |
| 绝缘电阻 / Insulation resistance                         | ≥ 100MΩ   |                     |                     |                     |
| 接触电阻 / Contact resistance                            | ≤ 5mΩ   |                     |                     |                     |
| 防护等级 / Degree of protection                          | IP67  |                     |                     |                     |
| 插拔次数 / Mechanical durability                         | ≥ 500次  |                     |                     |                     |
| 线材 / Wire rod  | PVC/PUR   |                     |                     |                     |

## 7/8后锁面板式公头插座 焊线型螺牙PG13.5

产品图 / Product photo



尺寸图 / Dimension

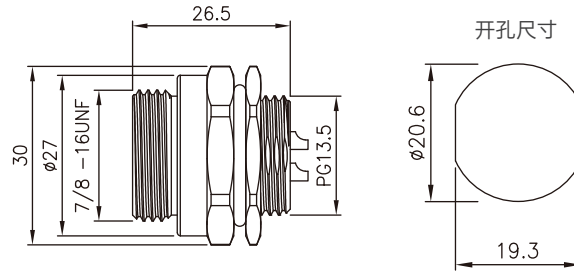

针位分布前视图 / Pin assignment front view

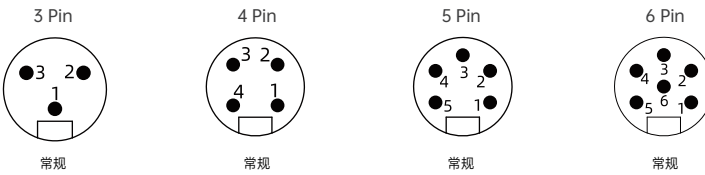

订货信息 / Order daea

| 芯数 / Number of cores | Coding | 料号 / Part number |
|----------------------|--------|------------------|
| 03 Pin               | A-code | M78003-03-001    |
| 04 Pin               | A-code | M78004-03-001    |
| 05 Pin               | A-code | M78005-03-001    |
| 06 Pin               | A-code | M78006-03-001    |

技术参数 / Specifications

| 芯数 / Pin                      | 03 Pin  | 04 Pin  | 05 Pin  | 06 Pin  |
|-------------------------------|---|---------|---------|---------|
| 额定电流 / Rated current          | 7 A   | 7 A     | 6 A     | 5A      |
| 额定电压(A/C交流) / Rated voltage   | 250V  | 250V    | 250V    | 250V    |
| 额定电压(D/C直流) / Rated voltage   | 250V  | 250V    | 250V    | 250V    |
| 线规 (mm²) / Wire gauge(mm²)    | 0.75mm²   | 0.75mm² | 0.75mm² | 0.75mm² |
| 线号 (AWG) / Wire gauge(AWG)    | 20AWG   | 20AWG   | 20AWG   | 20AWG   |
| 壳体材料 / Outer shell material   | 黄铜合金镀镍/PA+GF / Copper Alloy With Nickel Plated/PA+GF                  |         |         |         |
| 胶芯材料 / Housing material       | PA+GF/TPU   |         |         |         |
| 成型材料 / Molding material       | TPU/PVC   |         |         |         |
| 端子材料 / Pin material           | 黄铜镀金/磷铜镀金 / Brass With Gold Plated / Phosphor Bronze With Gold Plated |         |         |         |
| 适用温度 / Applicable temperature | -20 °C ~ +80 °C   |         |         |         |
| 绝缘电阻 / Insulation resistance  | ≥ 100MΩ   |         |         |         |
| 接触电阻 / Contact resistance     | ≤ 5mΩ   |         |         |         |
| 防护等级 / Degree of protection   | IP67  |         |         |         |
| 插拔次数 / Mechanical durability  | ≥ 500次  |         |         |         |
| 线材 / Wire rod                 | PVC/PUR   |         |         |         |

## 7/8后锁面板式母头插座 焊线型螺牙PG13.5

产品图 / Product photo



尺寸图 / Dimension

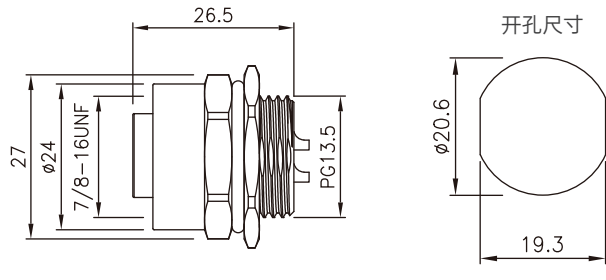

针位分布前视图 / Pin assignment front view

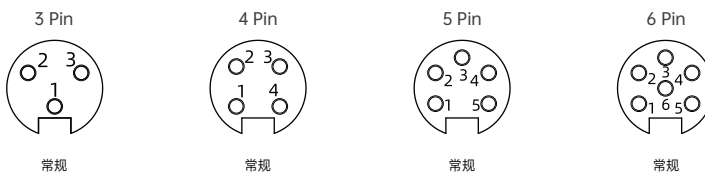

订货信息 / Order daea

| 芯数 / Number of cores | Coding | 料号 / Part number |
|----------------------|--------|------------------|
| 03 Pin               | A-code | M78003-04-001    |
| 04 Pin               | A-code | M78004-04-001    |
| 05 Pin               | A-code | M78005-04-001    |
| 06 Pin               | A-code | M78006-04-001    |

技术参数 / Specifications

| 芯数 / Pin   | 03 Pin  | 04 Pin              | 05 Pin              | 06 Pin              |
|--|---|---------------------|---------------------|---------------------|
| 额定电流 / Rated current                                 | 7 A   | 7 A                 | 6 A                 | 5A                  |
| 额定电压(A/C交流) / Rated voltage                          | 250V  | 250V                | 250V                | 250V                |
| 额定电压(D/C直流) / Rated voltage                          | 250V  | 250V                | 250V                | 250V                |
| 线规 (mm <sup>2</sup> ) / Wire gauge(mm <sup>2</sup> ) | 0.75mm <sup>2</sup>   | 0.75mm <sup>2</sup> | 0.75mm <sup>2</sup> | 0.75mm <sup>2</sup> |
| 线号 (AWG) / Wire gauge(AWG)                           | 20AWG   | 20AWG               | 20AWG               | 20AWG               |
| 壳体材料 / Outer shell material                          | 黄铜合金镀镍/PA+GF / Copper Alloy With Nickel Plated/PA+GF                  |                     |                     |                     |
| 胶芯材料 / Housing material                              | PA+GF/TPU   |                     |                     |                     |
| 成型材料 / Molding material                              | TPU/PVC   |                     |                     |                     |
| 端子材料 / Pin material                                  | 黄铜镀金/磷铜镀金 / Brass With Gold Plated / Phosphor Bronze With Gold Plated |                     |                     |                     |
| 适用温度 / Applicable temperature                        | -20 °C ~ +80 °C   |                     |                     |                     |
| 绝缘电阻 / Insulation resistance                         | ≥ 100MΩ   |                     |                     |                     |
| 接触电阻 / Contact resistance                            | ≤ 5mΩ   |                     |                     |                     |
| 防护等级 / Degree of protection                          | IP67  |                     |                     |                     |
| 插拔次数 / Mechanical durability                         | ≥ 500次  |                     |                     |                     |
| 线材 / Wire rod  | PVC/PUR   |                     |                     |                     |

# 一站式连接解决方案商

ONE-STOP CONNECTIVITY  
SOLUTION PROVIDER

**广东万连科技有限公司**

Guangdong Wanlian Technology Co., LTD

联系热线：400-888-3128

官网链接：[www.dzgu.com](http://www.dzgu.com)

联系地址：东莞市长安镇沙头西兴街6号



(扫码了解更多详情)